

IBM XL Fortran Enterprise Edition for AIX, V11.1



# Language Reference



IBM XL Fortran Enterprise Edition for AIX, V11.1



# Language Reference

**Note!**

Before using this information and the product it supports, be sure to read the general information under “Notices” on page 827.

**First Edition**

This edition applies to IBM XL Fortran Enterprise Edition for AIX, V11.1 (Program number 5724-S72) and to all subsequent releases and modifications until otherwise indicated in new editions. Make sure you are using the correct edition for the level of the product.

© Copyright International Business Machines Corporation 1990, 2007. All rights reserved.

US Government Users Restricted Rights – Use, duplication or disclosure restricted by GSA ADP Schedule Contract with IBM Corp.

---

# Contents

<b>About this document . . . . .</b>	<b>xi</b>
Who should read this document . . . . .	xi
How to use this document . . . . .	xi
How this document is organized . . . . .	xi
Conventions and terminology used in this document . . . . .	xii
Related information . . . . .	xv
IBM XL Fortran publications . . . . .	xv
Standards and specifications documents . . . . .	xvi
Other IBM publications . . . . .	xvii
Technical support . . . . .	xvii
How to send your comments . . . . .	xviii

<b>Chapter 1. XL Fortran for AIX . . . . .</b>	<b>1</b>
Language standards . . . . .	1
Fortran 2003 . . . . .	1
Fortran 95 . . . . .	2
Fortran 90 . . . . .	2
IBM Extensions . . . . .	2
Other standards and standards documents . . . . .	2

<b>Chapter 2. XL Fortran Language Fundamentals . . . . .</b>	<b>5</b>
Characters . . . . .	5
Names . . . . .	6
Statements . . . . .	7
Statement keywords . . . . .	7
Statement labels . . . . .	7
Lines and source formats . . . . .	7
Fixed source form . . . . .	8
Free source form . . . . .	11
IBM free source form . . . . .	12
Conditional compilation . . . . .	13
Order of statements and execution sequence . . . . .	14
Data types . . . . .	15
Type declaration: type parameters and specifiers . . . . .	16
Determining Type . . . . .	17
Data objects . . . . .	17
Constants . . . . .	18
Automatic objects . . . . .	18
Polymorphic entities . . . . .	18
Definition status of variables . . . . .	19
Allocation status . . . . .	26
Storage classes for variables . . . . .	26
Typeless literal constants . . . . .	28
Hexadecimal constants . . . . .	28
Octal constants . . . . .	29
Binary constants . . . . .	30
Hollerith constants . . . . .	30
Using typeless constants . . . . .	31

<b>Chapter 3. Intrinsic Data Types . . . . .</b>	<b>35</b>
Integer . . . . .	35
Real . . . . .	36
Complex . . . . .	39

Logical . . . . .	40
Character . . . . .	41
Examples of character constants . . . . .	43
Character substrings . . . . .	43
Byte . . . . .	44
Vector . . . . .	45
Pixel . . . . .	46
Unsigned . . . . .	46

<b>Chapter 4. Derived Types . . . . .</b>	<b>47</b>
Syntax of a derived type . . . . .	48
Component and procedure accessibility . . . . .	49
Default initialization . . . . .	49
Sequence derived types . . . . .	51
Extensible derived types . . . . .	51
Abstract types and deferred bindings . . . . .	52
Structure components . . . . .	53
Examples of references to structure components . . . . .	54
Allocatable components . . . . .	55
Procedure pointer component . . . . .	56
Component order . . . . .	57
Derived type Values . . . . .	58
Type-bound procedures . . . . .	58
Syntax of a type-bound procedure . . . . .	58
Specific binding . . . . .	59
Generic binding . . . . .	61
Final binding . . . . .	62
Procedure overriding . . . . .	63
Finalization . . . . .	65
The finalization process . . . . .	65
When finalization occurs . . . . .	65
Determining declared type for derived types . . . . .	66
Example of determining type with derived types . . . . .	66
An example with different component names . . . . .	67
Structure constructor . . . . .	67
Examples of Structure Constructors . . . . .	69

<b>Chapter 5. Array concepts . . . . .</b>	<b>71</b>
Arrays . . . . .	71
Bounds of a dimension . . . . .	71
Extent of a dimension . . . . .	72
Rank, shape, and size of an array . . . . .	72
Array declarators . . . . .	73
Explicit-shape arrays . . . . .	73
Examples of explicit-shape arrays . . . . .	74
Automatic arrays . . . . .	74
Adjustable arrays . . . . .	75
Pointee arrays . . . . .	75
Assumed-shape arrays . . . . .	75
Examples of assumed-shape arrays . . . . .	76
Deferred-shape arrays . . . . .	76
Allocatable arrays . . . . .	77
Array pointers . . . . .	78
Assumed-size arrays . . . . .	78
Examples of assumed-size arrays . . . . .	80

Array elements . . . . .	80
Array element order . . . . .	81
Array sections . . . . .	82
Subscript triplets . . . . .	83
Vector subscripts . . . . .	85
Array sections and substring ranges . . . . .	85
Array sections and structure components . . . . .	86
Rank and shape of array sections . . . . .	88
Array constructors . . . . .	88
Syntax of an array constructor . . . . .	88
Rules for array constructors . . . . .	89
Implied-DO list for an array constructor . . . . .	90
Expressions involving arrays . . . . .	90

**Chapter 6. Expressions and assignment. . . . . 93**

Introduction to expressions and assignment . . . . .	93
Primary . . . . .	93
Constant expressions . . . . .	94
Examples of constant expressions . . . . .	95
Initialization expressions . . . . .	95
Specification expressions . . . . .	96
Examples of specification expressions . . . . .	97
Operators and expressions . . . . .	98
Arithmetic. . . . .	98
Character. . . . .	100
General . . . . .	101
Logical . . . . .	102
Primary . . . . .	104
Relational . . . . .	105
Extended intrinsic and defined operations. . . . .	106
How expressions are evaluated . . . . .	107
Precedence of operators . . . . .	107
Using BYTE data objects. . . . .	110
Intrinsic assignment . . . . .	110
Arithmetic conversion . . . . .	112
WHERE construct . . . . .	113
Interpreting masked array assignments . . . . .	115
FORALL construct. . . . .	120
Interpreting the FORALL construct . . . . .	122
Data pointer assignment. . . . .	123
Examples of pointer assignment . . . . .	126
Procedure pointer assignment . . . . .	126
Integer pointer assignment . . . . .	127
Example of integer pointer assignment . . . . .	127

**Chapter 7. Execution Control . . . . . 129**

Statement blocks . . . . .	129
ASSOCIATE Construct . . . . .	129
DO construct . . . . .	131
The terminal statement . . . . .	131
DO WHILE construct. . . . .	135
Example . . . . .	135
IF construct . . . . .	136
Example . . . . .	137
SELECT CASE construct. . . . .	137
Examples. . . . .	139
SELECT TYPE construct. . . . .	139
Examples. . . . .	141
Associate names . . . . .	142

Branching . . . . .	142
---------------------	-----

**Chapter 8. Program units and procedures . . . . . 145**

Scope . . . . .	145
The scope of a name . . . . .	146
Association . . . . .	150
Host association . . . . .	150
Use association . . . . .	151
Construct Association . . . . .	152
Pointer association . . . . .	152
Integer pointer association . . . . .	154
Program units, procedures, and subprograms. . . . .	154
Internal procedures . . . . .	155
Interface concepts . . . . .	156
Interface blocks. . . . .	158
Example of an interface block . . . . .	160
Generic interface blocks . . . . .	161
Unambiguous generic procedure references . . . . .	161
Extending intrinsic procedures with generic interface blocks. . . . .	163
Defined operators . . . . .	163
Defined assignment . . . . .	165
User-defined derived-type Input/Output procedures . . . . .	166
Abstract interface . . . . .	169
Example of an abstract interface . . . . .	169
Main program . . . . .	170
Modules . . . . .	171
Example of a module. . . . .	173
Block data program unit. . . . .	174
Example of a block data program unit . . . . .	175
Function and subroutine subprograms . . . . .	175
Declaring procedures. . . . .	176
Procedure references . . . . .	177
Intrinsic procedures . . . . .	179
Conflicts between intrinsic procedure names and other names . . . . .	180
Arguments . . . . .	180
Actual argument specification . . . . .	180
Argument association . . . . .	183
%VAL and %REF . . . . .	184
Intent of dummy arguments . . . . .	185
Optional dummy arguments . . . . .	186
The passed-object dummy argument . . . . .	186
Restrictions on optional dummy arguments not present . . . . .	186
Length of character arguments . . . . .	187
Variables as dummy arguments . . . . .	188
Allocatable objects as dummy arguments . . . . .	190
Pointers as dummy arguments . . . . .	191
Procedures as dummy arguments . . . . .	192
Asterisks as dummy arguments . . . . .	193
Resolution of procedure references . . . . .	193
Rules for resolving procedure references to names. . . . .	194
Recursion . . . . .	195
Pure procedures . . . . .	196
Examples. . . . .	197
Elemental Procedures. . . . .	198
Examples. . . . .	199

**Chapter 9. XL Fortran Input/Output 201**

Records . . . . .	201
Formatted records . . . . .	201
Unformatted records . . . . .	202
Endfile records . . . . .	202
Files . . . . .	202
Definition of an external file . . . . .	202
File access methods . . . . .	203
Units . . . . .	205
Connection of a unit . . . . .	205
Data transfer statements . . . . .	206
Asynchronous Input/Output . . . . .	207
Advancing and nonadvancing Input/Output . . . . .	209
User-defined derived-type Input/Output . . . . .	
procedure interfaces . . . . .	210
User-defined derived-type Input/Output . . . . .	210
File position before and after data transfer. . . . .	212
Conditions and IOSTAT values . . . . .	214
End-of-record conditions . . . . .	214
End-of-file conditions. . . . .	215
Error conditions . . . . .	215

**Chapter 10. Input/Output formatting 223**

Format-directed formatting . . . . .	223
Complex editing . . . . .	223
Data edit descriptors . . . . .	223
Control edit descriptors . . . . .	228
Character string edit descriptors . . . . .	229
Effective list items . . . . .	230
Interaction of Input/Output lists and format . . . . .	
specifications . . . . .	231
Comma-separated Input/Output . . . . .	232
Data edit descriptors . . . . .	233
A (Character) Editing. . . . .	233
B (Binary) Editing . . . . .	234
E, D, and Q (Extended Precision) Editing . . . . .	235
DT Editing . . . . .	237
EN Editing . . . . .	237
ES Editing . . . . .	239
F (Real without Exponent) Editing . . . . .	240
G (General) Editing . . . . .	241
H Editing . . . . .	243
I (Integer) Editing . . . . .	244
L (Logical) Editing. . . . .	245
O (Octal) Editing . . . . .	245
Q (Character Count) Editing . . . . .	247
Z (Hexadecimal) Editing . . . . .	248
Control edit descriptors . . . . .	250
/ (Slash) Editing . . . . .	250
: (Colon) Editing . . . . .	251
\$ (Dollar) Editing . . . . .	251
BN (Blank Null) and BZ (Blank Zero) Editing . . . . .	251
DC and DP (Decimal) Editing . . . . .	252
P (Scale Factor) Editing . . . . .	253
RC, RD, RN, RP, RU, and RZ (Round) Editing . . . . .	254
S, SP, and SS (Sign Control) Editing . . . . .	254
T, TL, TR, and X (Positional) Editing . . . . .	255
List-directed formatting . . . . .	256
Value separators . . . . .	256
List-directed input. . . . .	257
List-directed output . . . . .	258

Namelist formatting . . . . .	260
Namelist input . . . . .	260
Namelist output . . . . .	265

**Chapter 11. Statements and attributes 269**

Attributes . . . . .	272
ABSTRACT . . . . .	273
ALLOCATABLE . . . . .	274
ALLOCATE . . . . .	275
ASSIGN . . . . .	278
ASSOCIATE . . . . .	279
ASYNCHRONOUS . . . . .	280
AUTOMATIC . . . . .	282
BACKSPACE . . . . .	283
BIND . . . . .	285
BLOCK DATA . . . . .	286
BYTE . . . . .	287
CALL . . . . .	290
CASE . . . . .	292
CHARACTER . . . . .	294
CLASS . . . . .	299
CLOSE . . . . .	301
COMMON . . . . .	303
COMPLEX . . . . .	307
CONTAINS . . . . .	312
CONTINUE . . . . .	313
CYCLE . . . . .	313
DATA . . . . .	314
DEALLOCATE . . . . .	318
Derived Type . . . . .	320
DIMENSION . . . . .	322
DO . . . . .	323
DO WHILE . . . . .	325
DOUBLE COMPLEX . . . . .	326
DOUBLE PRECISION . . . . .	329
ELSE . . . . .	332
ELSE IF . . . . .	333
ELSEWHERE . . . . .	333
END . . . . .	335
END (Construct) . . . . .	336
END INTERFACE . . . . .	339
END TYPE . . . . .	341
ENDFILE. . . . .	341
ENTRY . . . . .	343
ENUM/END ENUM . . . . .	347
EQUIVALENCE . . . . .	348
EXIT . . . . .	351
EXTERNAL . . . . .	352
FLUSH . . . . .	353
FORALL . . . . .	355
FORALL (construct) . . . . .	358
FORMAT . . . . .	360
FUNCTION . . . . .	362
GO TO (assigned) . . . . .	365
GO TO (computed) . . . . .	366
GO TO (unconditional) . . . . .	367
IF (arithmetic) . . . . .	368
IF (block) . . . . .	369
IF (logical) . . . . .	370
IMPLICIT . . . . .	371
IMPORT . . . . .	373

INQUIRE . . . . .	374
INTEGER . . . . .	383
INTENT . . . . .	387
INTERFACE . . . . .	389
INTRINSIC . . . . .	392
LOGICAL . . . . .	393
MODULE . . . . .	397
NAMELIST . . . . .	398
NULLIFY . . . . .	399
OPEN . . . . .	400
OPTIONAL . . . . .	407
PARAMETER . . . . .	409
PAUSE . . . . .	410
POINTER (Fortran 90) . . . . .	410
POINTER (integer) . . . . .	412
PRINT . . . . .	414
PRIVATE . . . . .	416
PROCEDURE . . . . .	418
PROCEDURE declaration . . . . .	419
PROGRAM . . . . .	422
PROTECTED . . . . .	422
PUBLIC . . . . .	424
READ . . . . .	425
REAL . . . . .	435
RECORD . . . . .	439
RETURN . . . . .	441
REWIND . . . . .	442
SAVE . . . . .	444
SELECT CASE . . . . .	446
SELECT TYPE . . . . .	447
SEQUENCE . . . . .	448
Statement Function . . . . .	449
STATIC . . . . .	451
STOP . . . . .	452
SUBROUTINE . . . . .	453
TARGET . . . . .	456
TYPE . . . . .	457
Type Declaration . . . . .	461
Type Guard . . . . .	467
USE . . . . .	468
VALUE . . . . .	472
VECTOR . . . . .	473
VIRTUAL . . . . .	473
VOLATILE . . . . .	474
WAIT . . . . .	476
WHERE . . . . .	478
WRITE . . . . .	481

**Chapter 12. Directives . . . . . 489**

Comment and noncomment form directives . . . . .	489
Comment form directives . . . . .	489
Noncomment form directives . . . . .	491
Directives and optimization . . . . .	492
Assertive directives . . . . .	492
Directives for Loop Optimization . . . . .	492
Detailed directive descriptions . . . . .	492
ASSERT . . . . .	492
BLOCK_LOOP . . . . .	494
CNCALL . . . . .	496
COLLAPSE . . . . .	497
EJECT . . . . .	498

INCLUDE . . . . .	498
INDEPENDENT . . . . .	500
#LINE . . . . .	503
LOOPID . . . . .	505
MEM_DELAY . . . . .	506
NEW . . . . .	506
NOVECTOR . . . . .	507
PERMUTATION . . . . .	508
@PROCESS . . . . .	509
SNAPSHOT . . . . .	509
SOURCEFORM . . . . .	511
STREAM_UNROLL . . . . .	512
SUBSCRIPTORDER . . . . .	513
UNROLL . . . . .	515
UNROLL_AND_FUSE . . . . .	517

**Chapter 13. Hardware-specific directives . . . . . 519**

CACHE_ZERO . . . . .	519
DCBFL . . . . .	519
EIEIO . . . . .	520
ISYNC . . . . .	520
LIGHT_SYNC . . . . .	520
PREFETCH . . . . .	521
PROTECTED STREAM . . . . .	524

**Chapter 14. Intrinsic procedures . . . . . 529**

Classes of intrinsic procedures . . . . .	529
Inquiry intrinsic functions . . . . .	529
Elemental intrinsic procedures . . . . .	529
System inquiry intrinsic functions . . . . .	530
Transformational intrinsic functions . . . . .	531
Intrinsic subroutines . . . . .	531
Data representation models . . . . .	531
Integer bit model . . . . .	531
Integer data model . . . . .	532
Real data model . . . . .	533
Detailed descriptions of intrinsic procedures . . . . .	534
ABORT() . . . . .	534
ABS(A) . . . . .	535
ACHAR(I, KIND) . . . . .	536
ACOS(X) . . . . .	536
ACOSD(X) . . . . .	537
ADJUSTL(String) . . . . .	537
ADJUSTR(String) . . . . .	538
AIMAG(Z), IMAG(Z) . . . . .	538
AINT(A, KIND) . . . . .	539
ALIGNX(K,M) . . . . .	540
ALL(MASK, DIM) . . . . .	540
ALLOCATED(X) . . . . .	541
ANINT(A, KIND) . . . . .	542
ANY(MASK, DIM) . . . . .	543
ASIN(X) . . . . .	544
ASIND(X) . . . . .	544
ASSOCIATED(Pointer, Target) . . . . .	545
ATAN(X) . . . . .	546
ATAND(X) . . . . .	547
ATAN2(Y, X) . . . . .	547
ATAN2D(Y, X) . . . . .	548
BIT_SIZE(I) . . . . .	549



BTEST(I, POS) . . . . .	550	LGAMMA(X) . . . . .	597
CEILING(A, KIND) . . . . .	551	LGE(String_A, String_B) . . . . .	598
CHAR(I, KIND) . . . . .	552	LGT(String_A, String_B) . . . . .	599
CMPLX(X, Y, KIND) . . . . .	553	LLE(String_A, String_B) . . . . .	599
COMMAND_ARGUMENT_COUNT() . . . . .	554	LLT(String_A, String_B) . . . . .	600
CONJG(Z) . . . . .	554	LOC(X) . . . . .	601
COS(X) . . . . .	555	LOG(X) . . . . .	601
COSD(X) . . . . .	556	LOG10(X) . . . . .	603
COSH(X) . . . . .	556	LOGICAL(L, KIND) . . . . .	603
COUNT(MASK, DIM, KIND) . . . . .	557	LSHIFT(I, SHIFT) . . . . .	604
CPU_TIME(TIME) . . . . .	558	MATMUL(MATRIX_A, MATRIX_B, MINDIM) . . . . .	604
CSHIFT(ARRAY, SHIFT, DIM) . . . . .	559	MAX(A1, A2, A3, ...) . . . . .	607
CVMGX(TSOURCE, FSOURCE, MASK) . . . . .	560	MAXEXPONENT(X) . . . . .	608
DATE_AND_TIME(DATE, TIME, ZONE, VALUES) . . . . .	562	MAXLOC(ARRAY, DIM, MASK, KIND) or MAXLOC(ARRAY, MASK, KIND) . . . . .	608
DBLE(A) . . . . .	563	MAXVAL(ARRAY, DIM, MASK) or MAXVAL(ARRAY, MASK) . . . . .	610
DCMPLX(X, Y) . . . . .	564	MERGE(TSOURCE, FSOURCE, MASK) . . . . .	611
DIGITS(X) . . . . .	565	MIN(A1, A2, A3, ...) . . . . .	612
DIM(X, Y) . . . . .	566	MINEXPONENT(X) . . . . .	613
DOT_PRODUCT(VECTOR_A, VECTOR_B) . . . . .	566	MINLOC(ARRAY, DIM, MASK, KIND) or MINLOC(ARRAY, MASK, KIND) . . . . .	614
DPROD(X, Y) . . . . .	567	MINVAL(ARRAY, DIM, MASK) or MINVAL(ARRAY, MASK) . . . . .	616
EOSHIFT(ARRAY, SHIFT, BOUNDARY, DIM) . . . . .	568	MOD(A, P) . . . . .	617
EPSILON(X) . . . . .	569	MODULO(A, P) . . . . .	618
ERF(X) . . . . .	570	MOVE_ALLOC(FROM, TO) . . . . .	619
ERFC(X) . . . . .	571	MVBITS(FROM, FROMPOS, LEN, TO, TOPOS) . . . . .	619
EXP(X) . . . . .	572	NEAREST(X,S) . . . . .	620
EXPONENT(X) . . . . .	572	NEW_LINE(A) . . . . .	621
EXTENDS_TYPE_OF(A, MOLD) . . . . .	573	NINT(A, KIND) . . . . .	622
FLOOR(A, KIND) . . . . .	574	NOT(I) . . . . .	622
FRACTION(X) . . . . .	575	NULL(MOLD) . . . . .	623
GAMMA(X) . . . . .	575	NUM_PARTHDS() . . . . .	624
GETENV(NAME, VALUE) . . . . .	576	NUMBER_OF_PROCESSORS(DIM) . . . . .	625
GET_COMMAND(COMMAND, LENGTH, STATUS) . . . . .	577	NUM_USRTHDS() . . . . .	626
GET_COMMAND_ARGUMENT(NUMBER, VALUE, LENGTH, STATUS) . . . . .	578	PACK(ARRAY, MASK, VECTOR) . . . . .	626
GET_ENVIRONMENT_VARIABLE(NAME, VALUE, LENGTH, STATUS, TRIM_NAME) . . . . .	579	POPCNT(I) . . . . .	627
HFIX(A) . . . . .	580	POPPAR(I) . . . . .	628
HUGE(X) . . . . .	581	PRECISION(X) . . . . .	629
IACHAR(C, KIND) . . . . .	582	PRESENT(A) . . . . .	630
IAND(I, J) . . . . .	582	PROCESSORS_SHAPE() . . . . .	630
IBCLR(I, POS) . . . . .	583	PRODUCT(ARRAY, DIM, MASK) or PRODUCT(ARRAY, MASK) . . . . .	631
IBITS(I, POS, LEN) . . . . .	584	QCMLX(X, Y) . . . . .	633
IBSET(I, POS) . . . . .	584	QEXT(A) . . . . .	634
ICHAR(C, KIND) . . . . .	585	RADIX(X) . . . . .	634
IEOR(I, J) . . . . .	586	RAND() . . . . .	635
ILEN(I) . . . . .	587	RANDOM_NUMBER(HARVEST) . . . . .	635
IMAG(Z) . . . . .	587	RANDOM_SEED(SIZE, PUT, GET, GENERATOR) . . . . .	636
INDEX(STRING, SUBSTRING, BACK, KIND) . . . . .	588	RANGE(X) . . . . .	637
INT(A, KIND) . . . . .	588	REAL(A, KIND) . . . . .	638
INT2(A) . . . . .	589	REPEAT(STRING, NCOPIES) . . . . .	639
IOR(I, J) . . . . .	590	RESHAPE(SOURCE, SHAPE, PAD, ORDER) . . . . .	640
IS_IOSTAT_END(I) . . . . .	591	RRSPACING(X) . . . . .	641
IS_IOSTAT_EOR(I) . . . . .	592	RSHIFT(I, SHIFT) . . . . .	642
ISHFT(I, SHIFT) . . . . .	592	SAME_TYPE_AS(A,B) . . . . .	642
ISHFTC(I, SHIFT, SIZE) . . . . .	593	SCALE(X,I) . . . . .	643
KIND(X) . . . . .	594	SCAN(STRING, SET, BACK, KIND) . . . . .	644
LBOUND(ARRAY, DIM, KIND) . . . . .	594	SELECTED_CHAR_KIND(NAME) . . . . .	645
LEADZ(I) . . . . .	595	SELECTED_INT_KIND(R) . . . . .	645
LEN(STRING, KIND) . . . . .	596		
LEN_TRIM(STRING, KIND) . . . . .	596		

SELECTED_REAL_KIND(P, R)	646
SET_EXPONENT(X,I)	647
SHAPE(SOURCE, KIND)	648
SIGN(A, B)	648
SIGNAL(I, PROC)	650
SIN(X)	650
SIND(X)	651
SINH(X)	652
SIZE(ARRAY, DIM, KIND)	652
SIZEOF(A)	653
SPACING(X)	654
SPREAD(SOURCE, DIM, NCOPIES)	655
SQRT(X)	656
SRAND(SEED)	657
SUM(ARRAY, DIM, MASK) or SUM(ARRAY, MASK)	658
SYSTEM(CMD, RESULT)	659
SYSTEM_CLOCK(COUNT, COUNT_RATE, COUNT_MAX)	660
TAN(X)	662
TAND(X)	663
TANH(X)	663
TINY(X)	664
TRANSFER(SOURCE, MOLD, SIZE)	664
TRANSPOSE(MATRIX)	666
TRIM(STRING)	666
UBOUND(ARRAY, DIM, KIND)	667
UNPACK(VECTOR, MASK, FIELD)	668
VERIFY(STRING, SET, BACK, KIND)	669

## Chapter 15. Hardware-specific intrinsic procedures . . . . . 671

FCFI(I)	671
FCTID(X)	671
FCTIDZ(X)	672
FCTIW(X)	672
FCTIWZ(X)	673
FMADD(A, X, Y)	673
FMSUB(A, X, Y)	674
FNABS(X)	674
FNMADD(A, X, Y)	675
FNMSUB(A, X, Y)	675
FRE(X)	676
FRES(X)	676
FRIM(A)	677
FRIN(A)	677
FRIP(A)	678
FRIZ(A)	678
FRSQRT(X)	678
FRSQRTES(X)	679
FSEL(X,Y,Z)	679
MTFSF(MASK, R)	680
MTFSFI(BF, I)	680
MULHY(RA, RB)	681
POPCNTB(I)	681
ROTATELI(RS, IS, SHIFT, MASK)	682
ROTATELM(RS, SHIFT, MASK)	682
SETFSB0(BT)	683
SETFSB1(BT)	683
SFTI(M, Y)	684
SWDIV(X,Y)	684

SWDIV_NOCHK(X,Y)	685
TRAP(A, B, TO)	686

## Chapter 16. VMX intrinsic procedures 687

VEC_ABS(ARG1)	687
VEC_ABSS(ARG1)	687
VEC_ADD(ARG1, ARG2)	688
VEC_ADDC(ARG1, ARG2)	688
VEC_ADDS(ARG1, ARG2)	689
VEC_ALL_EQ(ARG1, ARG2)	689
VEC_ALL_GE(ARG1, ARG2)	690
VEC_ALL_GT(ARG1, ARG2)	690
VEC_ALL_IN(ARG1, ARG2)	691
VEC_ALL_LE(ARG1, ARG2)	691
VEC_ALL_LT(ARG1, ARG2)	692
VEC_ALL_NAN(ARG1)	692
VEC_ALL_NE(ARG1, ARG2)	692
VEC_ALL_NGE(ARG1, ARG2)	693
VEC_ALL_NGT(ARG1, ARG2)	693
VEC_ALL_NLE(ARG1, ARG2)	694
VEC_ALL_NLT(ARG1, ARG2)	694
VEC_ALL_NUMERIC(ARG1)	695
VEC_AND(ARG1, ARG2)	695
VEC_ANDC(ARG1, ARG2)	696
VEC_ANY_EQ(ARG1, ARG2)	696
VEC_ANY_GE(ARG1, ARG2)	696
VEC_ANY_GT(ARG1, ARG2)	697
VEC_ANY_LE(ARG1, ARG2)	697
VEC_ANY_LT(ARG1, ARG2)	698
VEC_ANY_NAN(ARG1)	698
VEC_ANY_NE(ARG1, ARG2)	699
VEC_ANY_NGE(ARG1, ARG2)	699
VEC_ANY_NGT(ARG1, ARG2)	700
VEC_ANY_NLE(ARG1, ARG2)	700
VEC_ANY_NLT(ARG1, ARG2)	701
VEC_ANY_NUMERIC(ARG1)	701
VEC_ANY_OUT(ARG1, ARG2)	701
VEC_AVG(ARG1, ARG2)	702
VEC_CEIL(ARG1)	702
VEC_CMPB(ARG1, ARG2)	703
VEC_CMPEQ(ARG1, ARG2)	704
VEC_CMPGE(ARG1, ARG2)	704
VEC_CMPGT(ARG1, ARG2)	705
VEC_CMPLT(ARG1, ARG2)	705
VEC_CMPLT(ARG1, ARG2)	706
VEC_CONVERT(V, MOLD)	706
VEC_CTF(ARG1, ARG2)	707
VEC_CTS(ARG1, ARG2)	707
VEC_CTU(ARG1, ARG2)	708
VEC_DSS(ARG1)	708
VEC_DSSALL	708
VEC_DST(ARG1, ARG2, ARG3)	709
VEC_DSTST(ARG1, ARG2, ARG3)	709
VEC_DSTSTT(ARG1, ARG2, ARG3)	709
VEC_DSTT(ARG1, ARG2, ARG3)	710
VEC_EXPTE(ARG1)	710
VEC_FLOOR(ARG1)	711
VEC_LD(ARG1, ARG2)	711
VEC_LDE(ARG1, ARG2)	712
VEC_LDL(ARG1, ARG2)	712
VEC_LOGE(ARG1)	713

VEC_LVSL(ARG1, ARG2) . . . . .	713
VEC_LVSR(ARG1, ARG2) . . . . .	714
VEC_MADD(ARG1, ARG2, ARG3) . . . . .	714
VEC_MADDS(ARG1, ARG2) . . . . .	715
VEC_MAX(ARG1, ARG2) . . . . .	715
VEC_MERGEH(ARG1, ARG2) . . . . .	716
VEC_MERGEL(ARG1, ARG2) . . . . .	716
VEC_MFVSCR . . . . .	717
VEC_MIN(ARG1, ARG2) . . . . .	717
VEC_MLADD(ARG1, ARG2, ARG3) . . . . .	718
VEC_MRADDS(ARG1, ARG2, ARG3) . . . . .	718
VEC_MSUM(ARG1, ARG2, ARG3) . . . . .	719
VEC_MSUMS(ARG1, ARG2, ARG3) . . . . .	719
VEC_MTVSCR(ARG1) . . . . .	720
VEC_MULE(ARG1, ARG2) . . . . .	720
VEC_MULO(ARG1, ARG2) . . . . .	721
VEC_NMSUB(ARG1, ARG2, ARG3) . . . . .	721
VEC_NOR(ARG1, ARG2) . . . . .	722
VEC_OR(ARG1, ARG2) . . . . .	722
VEC_PACK(ARG1, ARG2) . . . . .	723
VEC_PACKPX(ARG1, ARG2) . . . . .	723
VEC_PACKS(ARG1, ARG2) . . . . .	724
VEC_PACKSU(ARG1, ARG2) . . . . .	724
VEC_PERM(ARG1, ARG2, ARG3) . . . . .	725
VEC_RE(ARG1) . . . . .	725
VEC_RL(ARG1, ARG2) . . . . .	726
VEC_ROUND(ARG1) . . . . .	726
VEC_RSQRTE(ARG1) . . . . .	727
VEC_SEL(ARG1, ARG2, ARG3) . . . . .	727
VEC_SL(ARG1, ARG2) . . . . .	728
VEC_SLD(ARG1, ARG2, ARG3) . . . . .	728
VEC_SLL(ARG1, ARG2) . . . . .	729
VEC_SLO(ARG1, ARG2) . . . . .	729
VEC_SPLAT(ARG1, ARG2) . . . . .	730
VEC_SPLAT_S8(ARG1) . . . . .	730
VEC_SPLAT_S16(ARG1) . . . . .	731
VEC_SPLAT_S32(ARG1) . . . . .	731
VEC_SPLAT_U8(ARG1) . . . . .	731
VEC_SPLAT_U16(ARG1) . . . . .	732
VEC_SPLAT_U32(ARG1) . . . . .	732
VEC_SR(ARG1, ARG2) . . . . .	733
VEC_SRA(ARG1, ARG2) . . . . .	733
VEC_SRL(ARG1, ARG2) . . . . .	734
VEC_SRO(ARG1, ARG2) . . . . .	734
VEC_ST(ARG1, ARG2, ARG3) . . . . .	735
VEC_STE(ARG1, ARG2, ARG3) . . . . .	735
VEC_STL(ARG1, ARG2, ARG3) . . . . .	736
VEC_SUB(ARG1, ARG2) . . . . .	737
VEC_SUBC(ARG1, ARG2) . . . . .	737
VEC_SUBS(ARG1, ARG2) . . . . .	738
VEC_SUM2S(ARG1, ARG2) . . . . .	738
VEC_SUM4S(ARG1, ARG2) . . . . .	739
VEC_SUMS(ARG1, ARG2) . . . . .	739
VEC_TRUNC(ARG1) . . . . .	740
VEC_UNPACKH(ARG1) . . . . .	740
VEC_UNPACKL(ARG1) . . . . .	741
VEC_XOR(ARG1, ARG2) . . . . .	741

<b>Chapter 17. Language interoperability features . . . . .</b>	<b>743</b>
Interoperability of types . . . . .	743

Intrinsic types . . . . .	743
Derived types . . . . .	743
Interoperability of Variables . . . . .	744
Interoperability of common blocks . . . . .	744
Interoperability of procedures . . . . .	745
The ISO_C_BINDING module . . . . .	745
Constants for use as kind type parameters . . . . .	745
Character constants . . . . .	747
Other constants . . . . .	747
Types . . . . .	747
Procedures . . . . .	747
Binding labels . . . . .	749

<b>Chapter 18. The ISO_FORTRAN_ENV intrinsic module . . . . .</b>	<b>751</b>
CHARACTER_STORAGE_SIZE . . . . .	751
ERROR_UNIT . . . . .	751
FILE_STORAGE_SIZE . . . . .	751
INPUT_UNIT . . . . .	752
IOSTAT_END . . . . .	752
IOSTAT_EOR . . . . .	752
NUMERIC_STORAGE_SIZE . . . . .	753
OUTPUT_UNIT . . . . .	753

<b>Chapter 19. Floating-point control and inquiry procedures . . . . .</b>	<b>755</b>
fpgets fpsets . . . . .	755
Efficient floating-point control and inquiry procedures . . . . .	756
xlf_fp_util Floating-Point Procedures . . . . .	758
IEEE Modules and support . . . . .	761
Compiling and exception handling . . . . .	762
General rules for implementing IEEE modules . . . . .	762
IEEE Derived data types and constants . . . . .	763
IEEE Operators . . . . .	765
IEEE PROCEDURES . . . . .	765
Rules for floating-point status . . . . .	781
Examples . . . . .	782

<b>Chapter 20. Service and utility procedures . . . . .</b>	<b>785</b>
General service and utility procedures . . . . .	785
List of service and utility procedures . . . . .	786
alarm_(time, func) . . . . .	786
bic_(X1, X2) . . . . .	787
bis_(X1, X2) . . . . .	787
bit_(X1, X2) . . . . .	788
clock_() . . . . .	788
ctime_(STR, TIME) . . . . .	788
date() . . . . .	789
dtime_(dtime_struct) . . . . .	789
etime_(etime_struct) . . . . .	790
exit_(exit_status) . . . . .	790
fdate_(str) . . . . .	790
fiosetup_(unit, command, argument) . . . . .	791
flush_(lunit) . . . . .	792
ftell_(lunit) . . . . .	792
ftell64_(lunit) . . . . .	793
getarg(i1,c1) . . . . .	793
getcwd_(name) . . . . .	794

getfd(lunit) . . . . .	794
getgid() . . . . .	794
getlog_(name) . . . . .	795
getpid() . . . . .	795
getuid() . . . . .	795
global_timef() . . . . .	796
gmtime_(stime, tarray) . . . . .	796
hostname_(name) . . . . .	796
iargc() . . . . .	797
idate_(idate_struct) . . . . .	797
ierrno() . . . . .	798
irand() . . . . .	798
irtc() . . . . .	798
itime_(itime_struct) . . . . .	799
jdate() . . . . .	799
lenchr_(str) . . . . .	799
lnblnk_(str) . . . . .	800
ltime_(stime, tarray) . . . . .	800
mclock() . . . . .	801
qsort_(array, len, isize, compar) . . . . .	801
qsort_down(array, len, isize) . . . . .	802
qsort_up(array, len, isize) . . . . .	802
rtc() . . . . .	803
setrteopts(c1) . . . . .	803
sleep_(sec) . . . . .	804
time_() . . . . .	804
timef() . . . . .	804
timef_delta(t) . . . . .	805
umask_(cmask) . . . . .	805

usleep_(msec) . . . . .	805
xl__trbk() . . . . .	806

**Chapter 21. Extensions for source compatibility. . . . . 807**

Record structures . . . . .	807
Declaring record structures . . . . .	808
Storage mapping . . . . .	810
Union and map. . . . .	811
Examples of union and map . . . . .	812

**Appendix A. Compatibility across standards . . . . . 815**

Fortran 90 compatibility . . . . .	816
Obsolescent features . . . . .	816
Deleted features . . . . .	818

**Appendix B. ASCII and EBCDIC character sets . . . . . 819**

**Notices . . . . . 827**

Trademarks and service marks . . . . .	829
--	-----

**Glossary . . . . . 831**

**Index . . . . . 841**

---

## About this document

This document, which is part of the XL Fortran documentation suite, describes the syntax, semantics, and IBM® implementation of the Fortran programming language on the AIX® operating system. Although XL Fortran implementations conform to Fortran 95, parts of Fortran 2003, and other specifications maintained by the ISO standards for the Fortran programming language, they also incorporate many extensions to the core language. These extensions have been implemented with the aims of enhancing usability in specific operating environments, assuring compatibility with other compilers, and supporting new hardware capabilities.

---

## Who should read this document

This document is a reference for users who already have experience programming in Fortran. Users new to Fortran can still use this document to find information on the language and features unique to XL Fortran; however, it does not aim to teach programming concepts nor to promote specific programming practices.

---

## How to use this document

While this document covers both standard and implementation-specific features of XL Fortran, it does not include information on the following topics, which are covered in other documents:

- Installation, system requirements, last-minute updates: see the *XL Fortran Installation Guide* and product README.
- Overview of XL Fortran features: see the *Getting Started with XL Fortran*.
- Compiler setup, compiling and running programs, compiler options, diagnostics: see the *XL Fortran Compiler Reference*.
- Optimizing, porting, OpenMP and SMP programming: see the *XL Fortran Optimization and Programming Guide*.
- Operating system commands related to the use of the compiler: *AIX Commands Reference, Volumes 1 - 6* and the AIX information center.

---

## How this document is organized

The following lists group information into sections that provide detail on particular language topics and implementations:

- XL Fortran language elements:
  - Fundamentals of the XL Fortran language
  - Intrinsic Data Types
  - Derived Types
  - Arrays
  - Expressions and assignment
  - Execution control
  - Program units and procedures
  - Understanding XL Fortran Input/Output
  - Input/Output formatting
  - Statements and attributes

- General directives
- Intrinsic procedures
- Language interoperability features
- The ISO\_FORTRAN\_ENV intrinsic module
- Extensions for source compatibility
- Procedures that provide hardware-related functionality, and additional features for those already familiar with the Fortran language:
  - Floating-point control and inquiry procedures
  - Hardware-specific directives
  - Hardware-specific intrinsic procedures
  - Service and utility procedures
- The appendices provide information on compatibility across standards for users of earlier versions of Fortran, and the ASCII and EBCDIC character sets mapping table.

---

## Conventions and terminology used in this document

### Typographical conventions

The following table explains the typographical conventions used in this document.







*Table 1. Typographical conventions*

Typeface	Indicates	Example
<i>italics</i>	Parameters or variables whose actual names or values are to be supplied by the user. Italics are also used to introduce new terms.	The maximum length of the <i>trigger_constant</i> in fixed source form is 4 for directives that are continued on one or more lines.
<u>underlining</u>	The default setting of a parameter of a compiler option or directive.	nomaf   <u>maf</u>
monospace	Examples of program code, command strings, or user-defined names.	Also, specify the following runtime options before running the program, with a command similar to the following: export XLFRTEOPTS="err_recovery=no: langlvl=90std"
<b>UPPERCASE bold</b>	Fortran programming keywords, statements, directives, and intrinsic procedures.	The <b>ASSERT</b> directive applies only to the <b>DO</b> loop immediately following the directive, and not to any nested <b>DO</b> loops.
<b>lowercase bold</b>	Lowercase programming keywords and library functions, compiler intrinsic procedures, file and directory names, examples of program code, command strings, or user-defined names.	If you specify <b>-O3</b> , the compiler assumes <b>-qhot=level=0</b> . To prevent all HOT optimizations with <b>-O3</b> , you must specify <b>-qnohot</b> .

### Qualifying elements (icons and bracket separators)

This document uses marked bracket separators to delineate large blocks of text and icons to delineate small segments of text as follows:

Table 2. Qualifying elements

Bracket separator text	Icon	Meaning
Fortran 2003	 	The text describes an IBM XL Fortran implementation of the Fortran 2003 standard.
Fortran 95	 	The text describes an IBM XL Fortran implementation of the Fortran 95 standard.
IBM extension	 	The text describes a feature that is an IBM XL Fortran extension to the standard language specifications.

### Syntax diagrams

Throughout this document, diagrams illustrate XL Fortran syntax. This section will help you to interpret and use those diagrams.



- Read the syntax diagrams from left to right, from top to bottom, following the path of the line.

The  symbol indicates the beginning of a command, directive, or statement.

The  symbol indicates that the command, directive, or statement syntax is continued on the next line.

The  symbol indicates that a command, directive, or statement is continued from the previous line.

The  symbol indicates the end of a command, directive, or statement.

Fragments, which are diagrams of syntactical units other than complete commands, directives, or statements, start with the  symbol and end with the  symbol.

IBM XL Fortran extensions are marked by a number in the syntax diagram with an explanatory note immediately following the diagram.

Program units, procedures, constructs, interface blocks and derived-type definitions consist of several individual statements. For such items, a box encloses the syntax representation, and individual syntax diagrams show the required order for the equivalent Fortran statements.

- Required items are shown on the horizontal line (the main path):



- Optional items are shown below the main path:

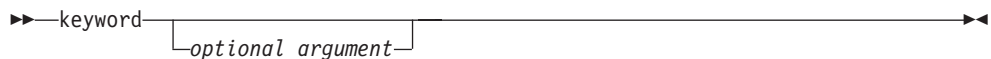

**Note:** Optional items (not in syntax diagrams) are enclosed by square brackets ([ and ]). For example, [UNIT=]u

- If you can choose from two or more items, they are shown vertically, in a stack.

If you *must* choose one of the items, one item of the stack is shown on the main path.



If choosing one of the items is optional, the entire stack is shown below the main path.

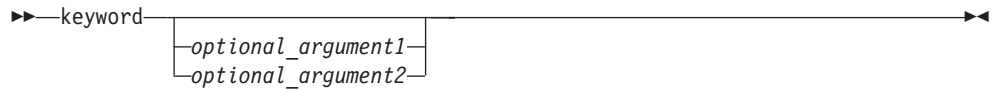

- An arrow returning to the left above the main line (a repeat arrow) indicates that you can make more than one choice from the stacked items or repeat an item. The separator character, if it is other than a blank, is also indicated:



- The item that is the default is shown above the main path.

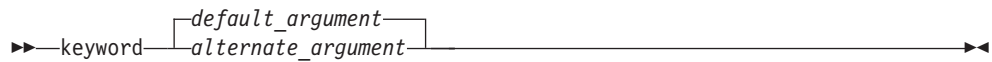

- Keywords are shown in nonitalic letters and should be entered exactly as shown.
- Variables are shown in italicized lowercase letters. They represent user-supplied names or values. If a variable or user-specified name ends in *\_list*, you can provide a list of these terms separated by commas.
- If punctuation marks, parentheses, arithmetic operators, or other such symbols are shown, you must enter them as part of the syntax.

### Sample syntax diagram

The following is an example of a syntax diagram with an interpretation:



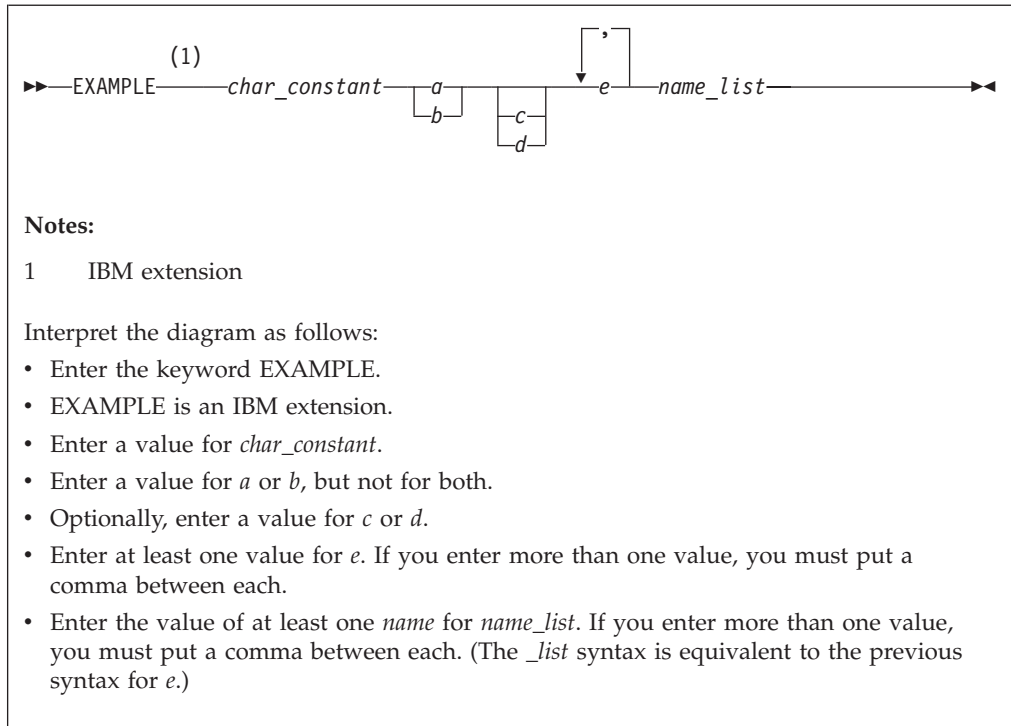

## Examples

The examples in this document, except where otherwise noted, are coded in a simple style that does not try to conserve storage, check for errors, achieve fast performance, or demonstrate all possible methods to achieve a specific result.

---

## Related information

The following sections provide information on documentation related to XL Fortran:

- “IBM XL Fortran publications”
- “Standards and specifications documents” on page xvi
- “Other IBM publications” on page xvii

## IBM XL Fortran publications

XL Fortran provides product documentation in the following formats:

- README files  
 README files contain late-breaking information, including changes and corrections to the product documentation. README files are located by default in the XL Fortran directory and in the root directory of the installation CD.
- Installable man pages  
 Man pages are provided for the compiler invocations and all command-line utilities provided with the product. Instructions for installing and accessing the man pages are provided in the *IBM XL Fortran Enterprise Edition for AIX, V11.1 Installation Guide*.
- Information center  
 The information center of searchable HTML files can be launched on a network and accessed remotely or locally. Instructions for installing and accessing the

online information center are provided in the *IBM XL Fortran Enterprise Edition for AIX, V11.1 Installation Guide*. The information center is also viewable on the Web at <http://publib.boulder.ibm.com/infocenter/comphelp/v9v111/index.jsp>.

- PDF documents

PDF documents are located by default in the `/usr/lpp/xlf/doc/LANG/pdf/` directory, where *LANG* is one of `en_US` or `ja_JP`. The PDF files are also available on the Web at <http://www.ibm.com/software/awdtools/fortran/xlfortran/library>.

The following files comprise the full set of XL Fortran product manuals:

*Table 3. XL Fortran PDF files*

Document title	PDF file name	Description
<i>IBM XL Fortran Enterprise Edition for AIX, V11.1 Installation Guide</i> , GC23-5834-00	install.pdf	Contains information for installing XL Fortran and configuring your environment for basic compilation and program execution.
<i>Getting Started with IBM XL Fortran Enterprise Edition for AIX, V11.1</i> , GC23-5835-00	getstart.pdf	Contains an introduction to the XL Fortran product, with information on setting up and configuring your environment, compiling and linking programs, and troubleshooting compilation errors.
<i>IBM XL Fortran Enterprise Edition for AIX, V11.1 Compiler Reference</i> , SC23-5833-00	cr.pdf	Contains information about the various compiler options and environment variables.
<i>IBM XL Fortran Enterprise Edition for AIX, V11.1 Language Reference</i> , SC23-5832-00	lr.pdf	Contains information about the Fortran programming language as supported by IBM, including language extensions for portability and conformance to non-proprietary standards, compiler directives and intrinsic procedures.
<i>IBM XL Fortran Enterprise Edition for AIX, V11.1 Optimization and Programming Guide</i> , SC23-5836-00	opg.pdf	Contains information on advanced programming topics, such as application porting, interlanguage calls, floating-point operations, input/output, application optimization and parallelization, and the XL Fortran high-performance libraries.

To read a PDF file, use the Adobe® Reader. If you do not have the Adobe Reader, you can download it (subject to license terms) from the Adobe Web site at <http://www.adobe.com>.

More documentation related to XL Fortran including redbooks, white papers, tutorials, and other articles, is available on the Web at:

<http://www.ibm.com/software/awdtools/fortran/xlfortran/library>

## Standards and specifications documents

XL Fortran is designed to support the following standards and specifications. You can refer to these standards for precise definitions of some of the features found in this document.

- *American National Standard Programming Language FORTRAN, ANSI X3.9-1978.*
- *American National Standard Programming Language Fortran 90, ANSI X3.198-1992.*
- *ANSI/IEEE Standard for Binary Floating-Point Arithmetic, ANSI/IEEE Std 754-1985.*

- *Federal (USA) Information Processing Standards Publication Fortran, FIPS PUB 69-1.*
- *Information technology - Programming languages - Fortran, ISO/IEC 1539-1:1991 (E).*
- *Information technology - Programming languages - Fortran - Part 1: Base language, ISO/IEC 1539-1:1997. (This document uses its informal name, Fortran 95.)*
- *Information technology - Programming languages - Fortran - Part 1: Base language, ISO/IEC 1539-1:2004. (This document uses its informal name, Fortran 2003.)*
- *Information technology - Programming languages - Fortran - Enhanced data type facilities, ISO/IEC JTC1/SC22/WG5 N1379.*
- *Information technology - Programming languages - Fortran - Floating-point exception handling, ISO/IEC JTC1/SC22/WG5 N1378.*
- *Military Standard Fortran DOD Supplement to ANSI X3.9-1978, MIL-STD-1753 (United States of America, Department of Defense standard). Note that XL Fortran supports only those extensions documented in this standard that have also been subsequently incorporated into the Fortran 90 standard.*
- *OpenMP Application Program Interface Version 2.5, available at <http://www.openmp.org>*

## Other IBM publications

- *AIX Commands Reference, Volumes 1 - 6, SC23-4888*
  - *AIX Technical Reference: Base Operating System and Extensions, Volumes 1 & 2, SC23-4913*
  - *AIX National Language Support Guide and Reference, SC23-4902*
  - *AIX General Programming Concepts: Writing and Debugging Programs, SC23-4896*
  - *AIX Assembler Language Reference, SC23-4923*
- All AIX documentation is available at <http://publib.boulder.ibm.com/infocenter/pseries/v5r3/index.jsp>.
- *ESSL for AIX V4.2 Guide and Reference, SA22-7904, available at <http://publib.boulder.ibm.com/infocenter/clresctr/index.jsp>*

---

## Technical support

Additional technical support is available from the XL Fortran Support page at <http://www.ibm.com/software/awdtools/fortran/xlfortran/support>. This page provides a portal with search capabilities to a large selection of technical support FAQs and other support documents.

If you cannot find what you need, you can send e-mail to [compinfo@ca.ibm.com](mailto:compinfo@ca.ibm.com).

For the latest information about XL Fortran, visit the product information site at <http://www.ibm.com/software/awdtools/fortran/xlfortran>.

---

## How to send your comments

Your feedback is important in helping to provide accurate and high-quality information. If you have any comments about this document or any other XL Fortran documentation, send your comments by e-mail to [compinfo@ca.ibm.com](mailto:compinfo@ca.ibm.com).

Be sure to include the name of the document, the part number of the document, the version of XL Fortran, and, if applicable, the specific location of the text you are commenting on (for example, a page number or table number).



---

## Chapter 1. XL Fortran for AIX

The *XL Fortran Language Reference* is part of a documentation suite that offers information on installing and using the IBM XL Fortran compiler on AIX. This document defines the syntax, semantics, and restrictions you must follow to write valid XL Fortran programs.

Fortran (FORmula TRANslation) is a high-level programming language primarily useful for engineering, mathematical, and scientific applications involving numeric computations.

XL Fortran implements Fortran 95, many features of Fortran 2003, and other language specifications maintained by the ISO standards for the Fortran programming language, and also incorporates many extensions to the core language. These extensions have been implemented with the aims of enhancing usability in specific operating environments, assuring compatibility with other compilers, and supporting new hardware capabilities. In theory, a program that compiles correctly on one standards-conforming compiler will compile and execute correctly under all other conforming compilers, insofar as hardware differences permit.

The compiler detects most non-conformities to the XL Fortran language rules, but may not detect some syntactic and semantic combinations. The compiler cannot detect all combinations for performance reasons, or because the nonconformance is only detectable at run time. XL Fortran programs that contain these undiagnosed combinations are not valid, whether or not the programs run as expected.

---

### Language standards

This section briefly summarizes the XL Fortran language standard implementations it follows. The Qualifying elements section contains details on how XL Fortran marks language standard specific information.

#### Fortran 2003

Segments of this document contain information based on the Fortran 2003 Standard. The standard is open to continual interpretation, modification and revision. IBM reserves the right to modify the behavior of any features of this product to conform with future interpretations of this standard.

The Fortran standard committees respond to questions of interpretation about aspects of Fortran. Some questions can relate to language features already implemented in the XL Fortran compiler. Any answers given by these committees relating to these language features can result in changes to future releases of the XL Fortran compiler, even if these changes result in incompatibilities with previous releases of the product.

Some of the major new features in Fortran 2003 are:

- Derived type enhancements
- Object-oriented programming support: type extension, type-bound procedures, type finalization, abstract and generic interfaces, polymorphism and PASS attribute.

- Scoping and data manipulation enhancements: allocatable components, VOLATILE attribute, MAX, MIN, MAXLOC, MINLOC, MAXVAL and MINVAL intrinsics for character type
- Input/Output enhancements: User defined derived type I/O, asynchronous transfer including the WAIT statement
- Subroutine enhancements: VALUE attribute, Procedure pointers, deferred CHARACTER length
- Support for IEEE Floating Point Standard (IEEE 1989) exceptions
- Interoperability with the C programming language
- Support for international usage: access to ISO 10646 4-byte characters

## Fortran 95

The Fortran 95 language standard is upward-compatible with the FORTRAN 77 and Fortran 90 language standards, excluding deleted features. Some of the improvements provided by the Fortran 95 standard are:

- Default initialization.
- **ELEMENTAL** procedures.
- The **FORALL** construct statement.
- **POINTER** initialization.
- **PURE** functions.
- Specification expressions.

## Fortran 90

Fortran 90 offers many new features and feature enhancements to FORTRAN 77. The following topics outline some of the key features that Fortran 90 brings to the FORTRAN 77 language:

- Array enhancements.
- Control construct enhancements.
- Derived types.
- Dynamic behavior.
- Free source form.
- Modules.
- Parameterized data types.
- Procedure enhancements.
- Pointers.

## IBM Extensions

An IBM extension generally modifies a rule or restriction from a given standards implementation. In this document, IBM extensions to the Fortran 2003, Fortran 95, and Fortran 90 standards. These are marked as indicated in Qualifying elements section.

## Other standards and standards documents

### OpenMP API Version 2.5

The OpenMP API provides additional features which you can use to supplement the existing FORTRAN 77, Fortran 90 and Fortran 95 language standards.

The OpenMP Architecture Review Board (ARB) responds to questions of interpretation about aspects of the API. Some of these questions can relate to interface features implemented in this version of the XL Fortran compiler. Any answers given by this committee relating to the interface can result in changes in future releases of the XL Fortran compiler, even if these changes result in incompatibilities with previous releases of the product.

You can find information pertaining to the implementation of OpenMP API Version 2.5 in the following sections:

- OpenMP environment variables in the *XL Fortran Optimization and Programming Guide*
- SMP Directives in the *XL Fortran Optimization and Programming Guide*.

### **Standards documents**

XL Fortran is designed according to the standards listed in the Standards documents section. You can refer to these standards for precise definitions of some of the features found in this document.





## Chapter 2. XL Fortran Language Fundamentals

This section describes the fundamental aspects of an XL Fortran application. Refer to the following headings for more information:

- “Characters”
- “Names” on page 6
- “Statements” on page 7
- “Lines and source formats” on page 7
- “Order of statements and execution sequence” on page 14
- “Data types” on page 15
- “Data objects” on page 17
- “Typeless literal constants” on page 28

### Characters

The XL Fortran character set consists of letters, digits, and special characters:

Table 4. The XL Fortran character set

Letters	Digits	Special Characters
A N a n	0	Blank
B O b o	1	Tab
C P c p	2	= Equal sign
D Q d q	3	+ Plus sign
E R e r	4	- Minus sign
F S f s	5	* Asterisk
G T g t	6	/ Slash
H U h u	7	( Left parenthesis
I V i v	8	) Right parenthesis
J W j w	9	[ Right square bracket
K X k x		] Left square bracket
L Y l y		, Comma
M Z m z		. Decimal point / period
		\$ Currency symbol
		' Apostrophe
		: Colon
		! Exclamation point
		" Double quotation mark
		% Percent sign
		& Ampersand
		; Semicolon
		? Question mark
		< Less than
		> Greater than
		_ Underscore

The characters have an order known as a collating sequence, which is the arrangement of characters that determines their sequence order for such processes as sorting, merging, and comparing. XL Fortran uses American National Standard Code for Information Interchange (ASCII) to determine the ordinal sequence of characters. See Appendix B, “ASCII and EBCDIC character sets,” on page 819 for a complete listing of the ASCII character set.



White space refers to blanks and tabs. The significance of white space depends on the source format. See “Lines and source formats” on page 7 for details.

A lexical token is a sequence of characters with an indivisible interpretation that forms a building block of a program. A lexical token can be a keyword, name, literal constant (not of type complex), operator, label, delimiter, comma, equal sign, colon, semicolon, percent sign, ::, or =>.

---

## Names

A name is a sequence of any or all of the following elements:

- Letters (A-Z, a-z)
- Digits (0-9)
- Underscores ( \_ )
-  Dollar signs (\$) 

The first character of a name must not be a digit.

In Fortran 2003, the maximum length of a name is 63 characters. In Fortran 90 and Fortran 95, the maximum length of a name is 31 characters.

---

### IBM Extension

---

In XL Fortran, the maximum length of a name is 250 characters. Although you can begin a name with an underscore, the AIX operating system as well as the XL Fortran compiler and libraries use reserved names that begin with underscores.

The compiler translates all letters in a source program into lowercase unless they are in a character context. Character context refers to characters within character literal constants, character-string edit descriptors, and Hollerith constants.

**Note:** When you specify the **-qmixed** compiler option, the compiler does not translate names to lowercase. For example, XL Fortran treats

ia Ia iA IA

the same by default, but treats lower and uppercase letters as distinct if you specify **-qmixed**.

---

### End of IBM Extension

---

A name can identify entities such as:

- A variable
- A constant
- A procedure
- A derived type
- A construct
- A **CRITICAL** construct
- A program unit
- A common block
- A namelist group

A subobject designator is a name followed by one or more selectors such as array element selectors, array section selectors, component selectors, and substring selectors. A subobject designator identifies the following items in a program unit:

- An array element

- An array section
- A character substring
- A structure component

---

## Statements

A Fortran statement is a sequence of lexical tokens. Statements are used to form program units.

————— **IBM Extension** —————

The maximum length of a statement in XL Fortran is 34 000 characters.

————— **End of IBM Extension** —————

See Statements and Attributes for more information on statements supported by XL Fortran.

## Statement keywords

A statement keyword is part of the syntax of a statement. A sequence of characters is not reserved in all contexts. A statement keyword is interpreted as an entity name if the keyword is used in such a context.

## Statement labels

A statement label is a sequence of one to five digits, one of which must be nonzero, that you can use to identify statements in a Fortran scoping unit. In fixed source form, a statement label can appear anywhere in columns 1 through 5 of the initial line of the statement. In free source form, such column restrictions do not apply.

————— **IBM Extension** —————

XL Fortran ignores all characters that appear in columns 1 through 5 on fixed source form continuation lines.

————— **End of IBM Extension** —————

Giving the same label to more than one statement in a scoping unit causes ambiguity, and the compiler generates an error. White space and leading zeros are not significant in distinguishing between statement labels. You can label any statement, but a statement label reference can only refer to an executable statement or a **FORMAT** statement. The statement making the reference and the statement referenced must be in the same scoping unit for the reference to resolve.

---

## Lines and source formats

A line is a horizontal arrangement of characters. A column is a vertical arrangement of characters, where each character, or each byte of a multibyte character, in a given column shares the same horizontal line position.

————— **IBM Extension** —————

Because XL Fortran measures lines in bytes, these definitions apply only to lines containing single-byte characters. Each byte of a multibyte character occupies one

column.

End of IBM Extension

The kinds of lines are:

<b>Initial line</b>	Is the first line of a statement.
<b>Continuation line</b>	Continues a statement beyond its initial line.
<b>Comment line</b>	<p>Does not affect the executable program and can be used for documentation. The comment text continues to the end of a line. Although comment lines can follow one another, a comment line cannot be continued. A line of all white space or a zero-length line is a comment line without any text. Comment text can contain any characters allowed in a character context.</p> <p>If an initial line or continuation line is not continued, or if it is continued but not in a character context, an inline comment can be placed on the same line, to the right of any statement label, statement text, and continuation character that may be present. An exclamation mark (!) begins an inline comment.</p>
<b>Conditional compilation line</b>	Indicates that the line should only be compiled if recognition of conditional compilation lines is enabled. A conditional compilation sentinel should appear on a conditional compilation line. For more information, see Conditional compilation.
<b>Debug Line</b>	Indicates that the line is for debugging code (for fixed source form only). In XL Fortran the letter D or X must be specified in column 1. For more information, see Debug lines.
<b>Directive line</b>	Provides instructions or information to the compiler in XL Fortran. For more information, see Comment form directives.

IBM Extension

In XL Fortran, source lines can be in fixed source form or free source form format. Use the **SOURCEFORM** directive to mix source formats within the same program unit. Fixed source form is the default when using the **f77**, **fort77**, **xf**, **xf\_r**, or **xf\_r7** invocation commands. Fortran 90 free source form is the default when using the **xf90**, **xf90\_r**, **xf90\_r7**, **xf95**, **xf95\_r**, **xf95\_r7**, **xf2003**, or **xf2003\_r** invocation commands.

See *Compiling XL Fortran Programs* in the *XL Fortran Compiler Reference* for details on invocation commands.

End of IBM Extension

## Fixed source form

IBM Extension

A fixed source form line is a sequence of 1 to 132 characters. The default line size is 72 characters. This is also the Fortran standard line size. You can change the default using the **-qfixed=right\_margin** compiler option. In XL Fortran there is no limit to the number of continuation lines for a statement, but the statement cannot be longer than 34 000 characters. Fortran 2003 limits the number of continuation lines to 255, while Fortran 95 limits the number of continuation lines to 19.

In fixed source form, columns beyond the right margin are not part of the line and you can use these columns for identification, sequencing, or any other purpose.

End of IBM Extension

Except within a character context, white space is insignificant. You can embed white space between and within lexical tokens, without affecting the way the compiler treats them.

IBM Extension

Tab formatting means that there is a tab character in columns 1 through 6 of an initial line in XL Fortran, which directs the compiler to interpret the next character as being in column 7.

End of IBM Extension

Requirements for lines and for items on those lines are:

- A comment line begins with a C, c, or an asterisk (\*) in column 1, or is all white space. Comments can also follow an exclamation mark (!), except when the exclamation mark is in column 6 or in a character context.
- For an initial line without tab formatting:
  - Columns 1 through 5 contain either blanks, a statement label, IBM a D or an X in column 1 optionally followed by a statement label. IBM
  - Column 6 contains a blank or zero.
  - Columns 7 through to the right margin contain statement text, possibly followed by other statements or by an inline comment.

IBM Extension

- For an initial line with tab formatting in XL Fortran:
  - Columns 1 through 6 begin with either blanks, a statement label, or a D or an X in column 1, optionally followed by a statement label. You must follow this with a tab character.
  - If you specify the **-qxflag=oldtab** compiler option, all columns from the column immediately following the tab character through to the right margin contain statement text, possibly followed by other statements and by an inline comment.
  - If you do not specify **-qxflag=oldtab** compiler option, all columns from column 7, which corresponds to the character after the tab, to the right margin contain statement text, possibly followed by other statements and by an inline comment.

End of IBM Extension

- For a continuation line:
  - Column 1 must not contain C, c, or an asterisk. Columns 1 through 5 must not contain an exclamation mark as the leftmost nonblank character.

IBM Extension

Column 1 can contain a D or an X which signifies a debug line in XL Fortran. Otherwise, these columns can contain any characters allowed in a character

context; these characters are ignored.

End of IBM Extension

- Column 6 must contain either a nonzero character or a nonwhite space character. The character in column 6 is the continuation character. Exclamation marks and semicolons are valid continuation characters.
- Columns 7 through to the right margin contain continued statement text, possibly followed by other statements and an inline comment.
- Neither the **END** statement or a statement whose initial line appears to be a program unit **END** statement can be continued.

A semicolon separates statements on a single source line, except when appearing in a character context, in a comment, or in columns 1 through 6. Two or more semicolon separators that are on the same line and are themselves separated by only white space or other semicolons are considered to be a single separator. A separator that is the last character on a line or before an inline comment is ignored. Statements following a semicolon on the same line cannot be labeled. Additional statements cannot follow a program unit **END** statement on the same line.

## Debug lines

IBM Extension

A debug line, allowed only for fixed source form, contains source code used for debugging and is specified in XL Fortran by the letter D, or the letter X in column 1. The handling of debug lines depends on the **-qdlines** or the **-qxlines** compiler options:

- If you specify the **-qdlines** option, the compiler interprets the D in column 1 as a blank, and handles such lines as lines of source code. If you specify **-qxlines**, the compiler interprets the X in column 1 as a blank and treats these lines as source code.
- If you do not specify **-qdlines** or **-qxlines**, the compiler handles such lines as comment lines. This is the default setting.

If you continue a debugging statement on more than one line, every continuation line must have a continuation character as well as a D or an X in column 1. If the initial line is not a debugging line, you can designate any continuation lines as debug lines provided that the statement is syntactically correct, whether or not you specify the **-qdlines** or **-qxlines** compiler option.

End of IBM Extension

## Example of fixed source form

```
C Column Numbers:
C      1      2      3      4      5      6      7
C2345678901234567890123456789012345678901234567890123456789012

!IBM* SOURCEFORM (FIXED)
CHARACTER CHARSTR ; LOGICAL X          ! 2 statements on 1 line
DO 10 I=1,10
  PRINT *, 'this is the index', I      ! with an inline comment
10 CONTINUE
C
CHARSTR="THIS IS A CONTINUED
X CHARACTER STRING"
! There will be 38 blanks in the string between "CONTINUED"
```

```

! and "CHARACTER". You cannot have an inline comment on
! the initial line because it would be interpreted as part
! of CHARSTR (character context).
100 PRINT *, IERROR
! The following debug lines are compiled as source lines if
! you use -qdlines
D   IF (I.EQ.IDEBUG.AND.
D   +   J.EQ.IDEBUG)   WRITE(6,*) IERROR
D   IF (I.EQ.
D   +   IDEBUG )
D   +   WRITE(6,*) INFO
END

```

## Free source form

A free source form line can specify up to 132 characters on each line. In XL Fortran, there is no limit to the number of continuation lines for a statement, but the statement cannot be longer than 34 000 characters. Fortran 2003 limits the number of continuation lines to 255, while Fortran 95 limits the number of continuation lines to 39.

Items can begin in any column of a line, subject to the following requirements for lines and items on those lines:

- A comment line is a line of white space or begins with an exclamation mark that is not in a character context.
- An initial line can contain any of the following items, in the following sequence:
  - A statement label.
  - Statement text. Note that statement text is required in an initial line.
  - Additional statements.
  - The ampersand continuation character.
  - An inline comment.
- If you want to continue an initial line or continuation line in a non-character context, the continuation line must start on the first noncomment line that follows the initial line or continuation line. To define a line as a continuation line, you must place an ampersand after the statements on the previous non-comment line.
- White space before and after the ampersand is optional, with the following restrictions:
  - If you also place an ampersand in the first nonblank character position of the continuation line, the statement continues at the next character position following the ampersand.
  - If a lexical token is continued, the ampersand must immediately follow the initial part of the token, and the remainder of the token must immediately start after the ampersand on the continuation line.
- A character context can be continued if the following conditions are true:
  - The last character of the continued line is an ampersand and is not followed by an inline comment. If the rightmost character of the statement text to be continued is an ampersand, you must enter a second ampersand as a continuation character.
  - The first nonblank character of the next noncomment line is an ampersand.

A semicolon separates statements on a single source line, except when the semicolon appears in a character context or in a comment. Two or more separators that are on the same line and are themselves separated by only white space or other semicolons are considered to be a single separator. A separator that is the last

character on a line or before an inline comment is ignored. Additional statements cannot follow a program unit **END** statement on the same line.

## White space

White space must not appear within lexical tokens, except in a character context or in a format specification. You can freely insert white space between tokens to improve readability, and white space must separate names, constants, and labels from adjacent keywords, names, constants, and labels.

Certain adjacent keywords can require white space. The following table lists keywords where white space is optional..

*Table 5. Keywords where white space is optional*

BLOCK DATA	END FILE	END STRUCTURE
DOUBLE COMPLEX	END FORALL	END SUBROUTINE
DOUBLE PRECISION	END FUNCTION	END TYPE
ELSE IF	END IF	END UNION
ELSE WHERE	END INTERFACE	END WHERE
END ASSOCIATE	END MAP	GO TO
END BLOCK DATA	END MODULE	IN OUT
END DO	END PROGRAM	SELECT CASE
END ENUM	END SELECT	SELECT TYPE

## Example of free source form

```
!IBM* SOURCEFORM (FREE(F90))
!
! Column Numbers:
!      1      2      3      4      5      6      7
!2345678901234567890123456789012345678901234567890123456789012
DO I=1,20
  PRINT *,'this statement&
    & is continued' ; IF (I.LT.5) PRINT *, I

ENDDO
EN&
&D                ! A lexical token can be continued
```

## IBM free source form

### IBM Extension

An IBM free source form line or statement is a sequence of up to 34000 characters. Items can begin in any column of a line, subject to the following requirements:

- A comment line begins with a double quotation mark in column 1, is a line of all white space, or is a zero-length line. A comment line must not follow a continued line. Comments can follow an exclamation mark except in a character context.
- An initial line can contain any of the following items, in the following sequence:
  - A statement label
  - Statement text
  - The minus sign continuation character
  - An inline comment
- A continuation line immediately follows a continued line and can contain any of the following items, in the following sequence:



- Statement text
- A continuation character
- An inline comment

If statement text on an initial line or continuation line is to continue, a minus sign indicates continuation of the statement text on the next line. In a character context, if the rightmost character of the statement text to continue is a minus sign, a second minus sign must be entered as a continuation character.

Except within a character context, white space is insignificant. You can embed white space between and within lexical tokens, without affecting how the compiler treats those tokens.

### Example of IBM free source form

```
!IBM* SOURCEFORM (FREE(IBM))
"
" Column Numbers:
"      1      2      3      4      5      6      7
"2345678901234567890123456789012345678901234567890123456789012
DO I=1,10
  PRINT *, 'this is -
           the index', I ! There will be 14 blanks in the string
                       ! between "is" and "the"
END DO
END
```

End of IBM Extension

## Conditional compilation

### IBM Extension

You can use sentinels to mark specific lines of an XL Fortran program for conditional compilation. This allows you to port code that contains statements that are only valid or applicable in an SMP environment to a non-SMP environment.

### Syntax for conditional compilation

▶—*cond\_comp\_sentinel*—*fortran\_source\_line*—▶

*cond\_comp\_sentinel*

is a conditional compilation sentinel defined by the current source form and is either:

- **!\$, C\$, c\$, or \*\$**, for fixed source form, or
- **!\$**, for free source form

*fortran\_source\_line*

is an XL Fortran source line

## Conditional compilation rules

### General rules:

A valid XL Fortran source line must follow the conditional compilation sentinel.

A conditional compilation line can contain the **EJECT**, **INCLUDE** or noncomment directives.

A conditional compilation sentinel must not contain embedded white space.

A conditional compilation sentinel must not follow a source statement or directive on the same line.

If you are continuing a conditional compilation line, the conditional compilation sentinel must appear on at least one of the continuation lines or on the initial line.

You must specify the **-qcclines** compiler option for conditional compilation lines to be recognized. To disable recognition of conditional compilation lines, specify the **-qnocclines** compiler option.

Trigger directives take precedence over conditional compilation sentinels. For example, if you specify the **-qdirective='\$'** option, then lines that start with the trigger, such as **!\$**, will be treated as comment directives, rather than conditional compilation lines.

### Fixed source form rules:

Conditional compilation sentinels must start in column 1.

All rules for fixed source form line length, case sensitivity, white space, continuation, tab formatting, and columns apply.

### Free source form rules:

Conditional compilation sentinels can start in any column.

All rules for free source form line length, case sensitivity, white space, and continuation apply. When you enable recognition of conditional compilation lines, the conditional compilation sentinel two white spaces replace the conditional compilation sentinel.

End of IBM Extension

---

## Order of statements and execution sequence

In the *Statement order* table, vertical lines delineate statements that you can intersperse, while horizontal lines delineate statements that you cannot intersperse. The numbers in the diagram reappear later in this document to identify groups of statements that you can specify in a particular context.

Table 6. *Statement order*

<b>1</b> PROGRAM, FUNCTION, SUBROUTINE, MODULE, or BLOCK DATA Statement
<b>2</b> USE Statements
<b>3</b> IMPORT Statements

Table 6. Statement order (continued)

4 DATA, FORMAT, and ENTRY Statements	5 Derived-Type Definitions, Interface Blocks, Type Declaration Statements, Enumeration Definitions, Procedure Declarations, Specification Statements, IMPLICIT Statements, and PARAMETER Statements
6 Executable constructs	
7 CONTAINS Statement	
8 Internal Subprograms or Module Subprograms	
9 END Statement	

Refer to Chapter 8, “Program units and procedures,” on page 145 or Chapter 11, “Statements and attributes,” on page 269 for more details on rules and restrictions concerning statement order.

The normal execution sequence is the processing of references to specification functions in any order, followed by the processing of executable statements in the order they appear in a scoping unit.

A transfer of control is an alteration of the normal execution sequence. Some statements that you can use to control the execution sequence are:

- Control statements like **DO** and **IF**.
- Input/output statements like **READ** and **WRITE** that contain an **END=**, **ERR=**, or **EOR=** specifier.

When you reference a procedure that is defined by a subprogram, the execution of the program continues with any specification functions referenced in the scoping unit of the subprogram that defines the procedure. The program resumes with the first executable statement following the **ENTRY**, **FUNCTION** or **SUBROUTINE** statement that defines the procedure. When you return from the subprogram, execution of the program continues from the point at which the procedure was referenced or to a statement referenced by an alternate return specifier.

In this document, any description of the sequence of events in a specific transfer of control assumes that no event, such as an error or the execution of a **STOP** statement, changes that normal sequence.

---

## Data types

A data type consists of a name, a set of valid values, constants used as a way to denote those values, and a set of operations to manipulate those values. The two categories of data types are Intrinsic types and Derived types.

A derived type is a composite data type that can contain both intrinsic and derived data types.

Intrinsic types and their operations are predefined and always accessible. The two classes of intrinsic types are numeric and nonnumeric, with a number of types comprising each class.

Table 7. Intrinsic Types

Numeric Intrinsic Types	Nonnumeric Intrinsic Types
Integer	Logical

Table 7. Intrinsic Types (continued)

Numeric Intrinsic Types	Nonnumeric Intrinsic Types
Real	Character
Complex	Vector <b>1</b>
Byte <b>1</b>	Byte <b>1</b>

**Notes:**

1. IBM Extension.

## Type declaration: type parameters and specifiers

This is an overview section on declaring the type of an entity. The Statements section contains the particular syntax details and rules for derived and intrinsic type declarations.

XL Fortran provides one or more representation methods for each intrinsic data type. You can optionally specify this representation method with a kind type parameter value, using *kind\_param* in your type declaration statement. This value can indicate:

- The range for the integer data type.
- The decimal precision and exponent range for the real data type.
- The decimal precision and exponent range for the complex data type.
- The representation method for the character data type.
- The representation method for the logical data type.

The **BYTE** intrinsic type does not have a kind type parameter.

A length type parameter specifies the number of characters for entities of type character.

A type specifier denotes the type of all entities declared in a type declaration statement. The **INTEGER**, **REAL**, **COMPLEX**, **LOGICAL**, and **CHARACTER** type specifiers can include a *kind\_selector*, that specifies the kind type parameter.

For example, here are some common ways you can declare a 4-byte integer:

- **INTEGER(4)**
- **INTEGER(KIND=4)**
- **INTEGER**, where the default integer size is set to 4 bytes.

This document references 4-byte integers as **INTEGER(4)**.

See *type\_spec* for details on using type specifiers.

### Applicable intrinsic procedures

For objects of an intrinsic type, the **KIND** intrinsic procedure returns the kind type parameter of its argument.

You can use the **LEN** intrinsic procedure to determine the length type parameter of a character object.

### IBM Extension

The **SIZEOF** intrinsic function returns the size of a data object in bytes.

End of IBM Extension

You can use a **type parameter inquiry** to identify the type parameter value of a data object.

Two examples of a type parameter inquiry are:

```
foo%kind
```

```
foo%len
```

## Determining Type

Each user-defined function or named entity has a data type. The type of an entity accessed by host or use association is determined in the host scoping unit or accessed module, respectively. The type of a name is determined, in the following sequence, in one of three ways:

1. Explicitly, in one of the following ways:
  - From a specified type declaration statement (see “Type Declaration” on page 461 for details).
  - For function results, from a specified type statement or its **FUNCTION** statement.
2. Implicitly, from a specified **IMPLICIT** type statement.
3. Implicitly, by predefined convention. By default (that is, in the absence of an **IMPLICIT** type statement), if the first letter of the name is I, J, K, L, M, or N, the type is default integer. Otherwise, the type is default real.

In a given scoping unit, if a letter, dollar sign, or underscore has not been specified in an **IMPLICIT** statement, the implicit type used is the same as the implicit type used by the host scoping unit. A program unit and interface body are treated as if they had a host with an **IMPLICIT** statement listing the predefined conventions.

The data type of a literal constant is determined by its form.

---

## Data objects

A data object is a variable, constant, or subobject of a constant.

A variable can have a value and can be defined or redefined during execution of an executable program. A variable can be:

- A scalar variable name
- An array variable name
- A subobject

A subobject of a variable is a portion of a named object that you can reference or define. A subobject can be:

- An array element.
- An array section
- A character substring
- A structure component

A subobject of a constant is a portion of a constant. The referenced portion can depend on a variable value.

## Constants

A constant has a value and cannot be defined or redefined during execution of an executable program. A constant with a name is a named constant. You can use either the **ENUM** statement or the **PARAMETER** attribute to provide a constant with a name. A constant without a name is a literal constant. A literal constant can be of intrinsic type or typeless. A typeless constant can be:

- Hexadecimal
- Octal
- Binary
- Hollerith

The optional kind type parameter of a literal constant can only be a digit string or a scalar integer named constant.

A signed literal constant can have a leading plus or minus sign. All other literal constants must be unsigned. These constants do not have a leading sign. The value zero is neither positive nor negative. You can specify zero as signed or unsigned.

## Automatic objects

An automatic object is a data object dynamically allocated within a procedure. This object is a local entity of a subprogram and can have a nonconstant character length, a nonconstant array bound, or both. An automatic object is not a dummy argument.

An automatic object always has the controlled automatic storage class.

You can not specify an automatic object in any of the following statements:

- **COMMON**
- **DATA**
- **EQUIVALENCE**
- **NAMELIST**

Also, automatic objects can not have the **AUTOMATIC**, **PARAMETER**, **SAVE**, or **STATIC** attributes. You can not initialize or define an automatic object with an initialization expression in a type declaration statement, but an automatic object can have a default initialization. An automatic object must not appear in the specification part of a main program or module.

## Polymorphic entities

---

### Fortran 2003

---

A polymorphic entity is a data entity that is able to be of differing types during program execution. The type of a data entity at a particular point during execution of a program is its dynamic type. The declared type of a data entity is the type that it is declared to have, either explicitly or implicitly.

You use the **CLASS** type specifier to declare polymorphic objects. If the **CLASS** type specifier contains a type name, the declared type of a polymorphic object is that type.

You can use the **CLASS(\*)** specifier to declare an unlimited polymorphic object. An unlimited polymorphic entity is not declared to have a type. It is not considered to have the same declared type as any other entity, including another unlimited polymorphic entity.

A nonpolymorphic entity is type-compatible only with entities of the same type. For a polymorphic entity, type compatibility is based on its declared type: a polymorphic entity that is not unlimited polymorphic is type-compatible with entities of the same type or any of its extensions. Even though an unlimited polymorphic entity is not considered to have a declared type, it is type-compatible with all entities.

An entity is said to be type-compatible with a type if it is type-compatible with entities of that type. An entity is type-, kind-, and rank-compatible (TKR) with another entity if the first entity is type-compatible with the second, the kind type parameters of the first entity have the same values as corresponding kind type parameters of the second, and both entities have the same rank.

Only components of the declared type of a polymorphic object may be designated by component selection.

A polymorphic allocatable object may be allocated to be of any type with which it is type-compatible. A polymorphic pointer or dummy argument may, during program execution, be associated with objects with which it is type-compatible.

The following table lists the dynamic type of objects.

*Table 8. Dynamic type of objects*

<b>Object</b>	<b>Dynamic type</b>
Allocated allocatable polymorphic object	The type with which the object was allocated.
Associated polymorphic pointer	The dynamic type of the pointer's target.
Nonallocatable nonpointer polymorphic dummy argument	The dynamic type of dummy's associated actual argument.
Unallocated allocatable	The allocatable object's declared type.
Disassociated pointer	The pointer's declared type.
Entity identified by an associate name	The dynamic type of the selector with which the object is associated.
Nonpolymorphic object	The object's declared type.

End of Fortran 2003

## Definition status of variables

A variable is either defined or undefined, and its definition status can change during program execution. A named constant has a value and cannot be defined or redefined during program execution.

Arrays (including sections), structures, and variables of character, complex or derived-type are objects made up of zero or more subobjects. Associations can be established between variables and subobjects and between subobjects of different variables.

- An object is defined if all of its subobjects are defined. That is, each object or subobject has a value that does not change until it becomes undefined or until it is redefined with a different value.
- A derived type scalar object is defined if and only if all of its nonpointer components are defined.
- A complex or character scalar object is defined if and only if all of its subobjects are defined.
- If an object is undefined, at least one of its subobjects is undefined. An undefined object or subobject cannot provide a predictable value.

Variables are initially defined if they are specified to have initial values by **DATA** statements, type declaration statements, or **STATIC** statements. Variables with the **BIND** attribute that are initialized by means other than Fortran are also initially defined. In addition, default initialization can cause a variable to be initially defined. Zero-sized arrays and zero-length character objects are always defined.

All other variables are initially undefined.

### Events causing definition

The following events will cause a variable to become defined:

1. Execution of an intrinsic assignment statement other than a masked array assignment statement  or **FORALL** assignment statement  causes the variable that precedes the equal sign to become defined.  
Execution of a defined assignment statement may cause all or part of the variable that precedes the equal sign to become defined.
2. Execution of a masked array assignment statement  or **FORALL** assignment statement  may cause some or all of the array elements in the assignment statement to become defined.
3. As execution of an input statement proceeds, each variable that is assigned a value from the input file becomes defined at the time that data are transferred to it. Execution of a **WRITE** statement whose unit specifier identifies an internal file causes each record that is written to become defined.  
As execution of an asynchronous input statement proceeds, the variable does not become defined until the matching **WAIT** statement is executed.
4. Execution of a **DO** statement causes the **DO** variable, if any, to become defined.

Fortran 95

5. Default initialization may cause a variable to be initially defined.

End of Fortran 95

6. Beginning of execution of the action specified by an implied-**DO** list in an input/output statement causes the implied-**DO** variable to become defined.
7. Execution of an **ASSIGN** statement causes the variable in the statement to become defined with a statement label value.
8. A reference to a procedure causes the entire dummy argument data object to become defined if the dummy argument does not have **INTENT(OUT)**, and the entire corresponding actual argument is defined with a value that is not a statement label.

A reference to a procedure causes a subobject of a dummy argument that does not have **INTENT(OUT)** to become defined if the corresponding subobject of the corresponding actual argument is defined.



9. Execution of an input/output statement containing an **IOSTAT=** specifier causes the specified integer variable to become defined.

**Fortran 2003**

10. Execution of an input/output statement containing an **IOMSG=** specifier causes the specified character variable to become defined when an error, end-of-file or end-of-record occurs.

**End of Fortran 2003**

11. Execution of a **READ** statement containing a **SIZE=** specifier causes the specified integer variable to become defined.
12. Execution of a **READ** or **WRITE** statement in XL Fortran containing an **ID=** specifier causes the specified integer variable to become defined.
13. Execution of a **WAIT** statement in XL Fortran containing a **DONE=** specifier causes the specified logical variable to become defined.
14. Execution of a synchronous **READ** or **WRITE** statement in XL Fortran containing a **NUM=** specifier causes the specified integer variable to become defined.

Execution of an asynchronous **READ** or **WRITE** statement containing a **NUM=** specifier does not cause the specified integer variable to become defined. The integer variable is defined upon execution of the matching **WAIT** statement.

15. Execution of an **INQUIRE** statement causes any variable that is assigned a value during the execution of the statement to become defined if no error condition exists.
16. When a character storage unit becomes defined, all associated character storage units become defined.

When a numeric storage unit becomes defined, all associated numeric storage units of the same type become defined, except that variables associated with the variable in an **ASSIGN** statement become undefined when the **ASSIGN** statement is executed. When an entity of type **DOUBLE PRECISION** becomes defined, all totally associated entities of double precision real type become defined.

A nonpointer scalar object of type nondefault integer, real other than default or double precision, nondefault logical, nondefault complex, nondefault character of any length, or nonsequence type occupies a single unspecified storage unit that is different for each case. A pointer that is distinct from other pointers in at least one of type, kind, and rank occupies a single unspecified storage unit. When an unspecified storage unit becomes defined, all associated unspecified storage units become defined.

17. When a default complex entity becomes defined, all partially associated default real entities become defined.
18. When both parts of a default complex entity become defined as a result of partially associated default real or default complex entities becoming defined, the default complex entity becomes defined.
19. When all components of a numeric sequence structure or character sequence structure become defined as a result of partially associated objects becoming defined, the structure becomes defined.
20. Execution of an **ALLOCATE** or **DEALLOCATE** statement with a **STAT=** specifier causes the variable specified by the **STAT=** specifier to become

defined.

**Fortran 2003**

21. If an error condition occurs during the execution of an **ALLOCATE** or **DEALLOCATE** statement that has an **ERRMSG=** specifier, the *errmsg-variable* becomes defined.

**End of Fortran 2003**

22. Allocation of a zero-sized array causes the array to become defined.
23. Invocation of a procedure causes any automatic object of zero size in that procedure to become defined.
24. Execution of a pointer assignment statement that associates a pointer with a target that is defined causes the pointer to become defined.
25. Invocation of a procedure that contains a nonpointer, nonallocatable, automatic object, causes all nonpointer default-initialized subcomponents of the object to become defined.
26. Invocation of a procedure that contains a nonpointer nonallocatable **INTENT(OUT)** dummy argument causes all nonpointer default-initialized subcomponents of the object to become defined.
27. Allocation of an object of a derived type where a nonpointer component is initialized by default initialization, causes the component and its subobjects to become defined.

**Fortran 95**

28. In a **FORALL** statement or construct used in Fortran 95, the *index-name* becomes defined when the *index-name* value set is evaluated.

**End of Fortran 95**

**IBM Extension**

29. If a **THREADPRIVATE** nonpointer nonallocatable variable that does not appear in a **COPYIN** clause is defined on entry into the first parallel region, each new thread's copy of the variable is defined.
30. If a **THREADPRIVATE** common block that does not appear in a **COPYIN** clause is defined on entry into the first parallel region, each new thread's copy of the variable is defined.
31. For **THREADPRIVATE** variables that are specified in a **COPYIN** clause, each new thread duplicates the master thread's definition, allocation and association status of these variables. Therefore, if the master thread's copy of a variable is defined on entry to a parallel region, each new thread's copy of the variable will also be defined.
32. For **THREADPRIVATE** common blocks that are in a **COPYIN** clause, each new thread duplicates the master thread's definition, allocation and association status of the variables in these common blocks. Therefore, if the master thread's copy of a common block variable is defined on entry to a parallel region, each new thread's copy of the common block variable will also be defined.
33. When a variable is specified in a **FIRSTPRIVATE** clause of a **PARALLEL**, **PARALLEL DO**, **DO**, **PARALLEL SECTIONS**, **PARALLEL WORKSHARE**, **SECTIONS**, or **SINGLE** directive, each new thread duplicates the master

thread's definition and association status of the variable. Therefore, if the master thread's copy of a variable is defined on entry to a parallel region, each new thread's copy of the variable will also be defined.

34. For each variable, or variable inside a common block, specified in a **COPYPRIVATE** clause, then after the execution of the code enclosed in the **SINGLE** construct and before any threads in the team have left the construct, all copies of the variable become defined as follows:
  - If the variable has the **POINTER** attribute, then copies of the variable in other threads in the team have the same pointer association status as the copy of the variable belonging to the thread that executed the code enclosed in the **SINGLE** construct.
  - If the variable does not have the **POINTER** attribute, then copies of the variable in other threads in the team have the same definition as the copy of the variable belonging to the thread that executed the code enclosed in the **SINGLE** construct.

End of IBM Extension

### Events causing undefinition

The following events will cause a variable to become undefined:

1. When a variable of a given type becomes defined, all associated variables of different type become undefined. However, when a variable of type default real is partially associated with a variable of type default complex, the complex variable does not become undefined when the real variable becomes defined and the real variable does not become undefined when the complex variable becomes defined. When a variable of type default complex is partially associated with another variable of type default complex, definition of one does not cause the other to become undefined.
2. Execution of an **ASSIGN** statement causes the variable in the statement to become undefined as an integer. Variables that are associated with the variable also become undefined.
3. If the evaluation of a function may cause an argument of the function or a variable in a module or in a common block to become defined, and if a reference to the function appears in an expression in which the value of the function is not needed to determine the value of the expression, the argument or variable becomes undefined when the expression is evaluated.
4. The execution of a **RETURN** statement or **END** statement within a subprogram causes all variables that are local to its scoping unit, or that are local to the current instance of its scoping unit for a recursive invocation, to become undefined, except for the following:
  - a. Variables with the **SAVE** or **STATIC** attribute.
  - b. Variables in blank common.
  - c. According to Fortran 90, variables in a named common block that appears in the subprogram and appears in at least one other scoping unit that is making either a direct or indirect reference to the subprogram. IBM XL Fortran does not undefine these variables, unless they are part of a threadlocal common block. IBM
  - d. Variables accessed from the host scoping unit.
  - e. According to Fortran 90, variables accessed from a module that also is referenced directly or indirectly by at least one other scoping unit that is making either a direct or indirect reference to the subprogram. IBM XL Fortran does not undefine these variables. IBM

- f. According to Fortran 90, variables in a named common block that are initially defined and that have not been subsequently defined or redefined. IBM XL Fortran does not undefine these variables. IBM
5. When an error condition or end-of-file condition occurs during execution of an input statement, all of the variables specified by the input list or namelist-group of the statement become undefined.
  6. When an error condition, end-of-file condition, or end-of-record condition occurs during execution of an input/output statement and the statement contains any implied-DO lists, all of the implied-DO variables in the statement become undefined.
  7. Execution of a defined assignment statement may leave all or part of the variable that precedes the equal sign undefined.
  8. Execution of a direct access input statement that specifies a record that has not been written previously causes all of the variables specified by the input list of the statement to become undefined.
  9. Execution of an **INQUIRE** statement may cause the **NAME=**, **RECL=**, **NEXTREC=**, and **POS=** variables to become undefined.
  10. When a character storage unit becomes undefined, all associated character storage units become undefined.  
 When a numeric storage unit becomes undefined, all associated numeric storage units become undefined unless the undefinition is a result of defining an associated numeric storage unit of different type (see (1) above).  
 When an entity of double precision real type becomes undefined, all totally associated entities of double precision real type become undefined.  
 When an unspecified storage unit becomes undefined, all associated unspecified storage units become undefined.
  11. A reference to a procedure causes part of a dummy argument to become undefined if the corresponding part of the actual argument is defined with a value that is a statement label value.
  12. When an allocatable entity is deallocated, it becomes undefined. Successful execution of an **ALLOCATE** statement for a nonzero-sized object for which default initialization has not been specified causes the object to become undefined.
  13. Execution of an **INQUIRE** statement causes all inquiry specifier variables to become undefined if an error condition exists, except for the variable in the **IOSTAT=** or F2003 **IOMSG=** F2003 specifier, if any.
  14. When a procedure is invoked:
    - a. An optional dummy argument that is not associated with an actual argument is undefined.
    - b. A nonpointer dummy argument with **INTENT(OUT)** and its associated actual argument are undefined, except for nonpointer direct components that have default initialization.
    - c. A pointer dummy argument with **INTENT(OUT)** and its associated actual argument have an association status of undefined.
    - d. A subobject of a dummy argument is undefined if the corresponding subobject of the actual argument is undefined.
    - e. The function result variable is undefined, unless it was declared with the **STATIC** attribute and was defined in a previous invocation.

15. When the association status of a pointer becomes undefined or disassociated, the pointer becomes undefined.

**Fortran 95**

16. When the execution of a **FORALL** statement or construct in Fortran 95 has completed, the *index-name* becomes undefined.

**End of Fortran 95**

**Fortran 2003**

17. When execution of a **RETURN** or **END** statement causes a variable to become undefined, any variable of type **C\_PTR** becomes undefined if its value is the C address of any part of the variable that becomes undefined.
18. When a variable with the **TARGET** attribute is deallocated, any variable of type **C\_PTR** becomes undefined if its value is the C address of any part of the variable that is deallocated.

**End of Fortran 2003**

**IBM Extension**

19. When a variable is specified in either the **PRIVATE** or **LASTPRIVATE** clause of a **PARALLEL**, **PARALLEL DO**, **DO**, **PARALLEL SECTIONS**, **PARALLEL WORKSHARE**, **SECTIONS** or **SINGLE** directive, each new thread's copy of the variable is undefined when the thread is first created.
20. When a variable is specified in a **FIRSTPRIVATE** clause of a **PARALLEL**, **PARALLEL DO**, **DO**, **PARALLEL SECTIONS**, **PARALLEL WORKSHARE**, **SECTIONS** or **SINGLE** directive, each new thread duplicates the master thread's definition and association status of the variable. Therefore, if the master thread's copy of a variable is undefined on entry to a parallel region, each new thread's copy of the variable will also be undefined.
21. When a variable is specified in the **NEW** clause of an **INDEPENDENT** directive, the variable is undefined at the beginning of every iteration of the following **DO** loop.
22. When a variable appears in asynchronous input, that variable becomes undefined, and remains undefined, until the matching **WAIT** statement is reached.
23. If a **THREADPRIVATE** common block or a **THREADPRIVATE** variable is specified in a **COPYIN** clause, each new thread duplicates the master thread's definition, allocation and association status of the variables. Therefore, if the master thread's copy of a variable is undefined on entry to a parallel region, each new thread's copy of the variable will also be undefined.
24. **F2003** If a **THREADPRIVATE** common block variable or a **THREADPRIVATE** variable has the **ALLOCATABLE** attribute, the allocation status of each copy created will be not currently allocated. **F2003**
25. If a **THREADPRIVATE** common block variable or a **THREADPRIVATE** variable has the **POINTER** attribute with an initial association status of disassociated through either default or explicit initialization, each copy will have an association status of disassociated. Otherwise the association status of each copy is undefined.
26. If a **THREADPRIVATE** common block variable or a **THREADPRIVATE** variable has neither the **ALLOCATABLE** nor the **POINTER** attribute and is

initially defined through default or explicit initialization, each copy has the same definition. Otherwise, each copy is undefined.

End of IBM Extension

## Allocation status

The allocation status of an allocatable object is one of the following during program execution:

- Not currently allocated, which means that the object has never been allocated or that the last operation on it was a deallocation.
- Currently allocated, which means that the object has been allocated by an **ALLOCATE** statement and has not been subsequently deallocated.

IBM Extension

- Undefined, which means that the object does not have the **SAVE** or **STATIC** attribute and was currently allocated when execution of a **RETURN** or **END** statement resulted in no executing scoping units having access to it.

In XL Fortran, undefined status is only available when you use the **-qxlf90=noautodealloc** option.

End of IBM Extension

If the allocation status of an allocatable object is currently allocated, the object may be referenced and defined. An allocatable object that is not currently allocated must not be referenced or defined. If the allocation status of an allocatable object is undefined, the object must not be referenced, defined, allocated, or deallocated.

When the allocation status of an allocatable object changes, the allocation status of any associated allocatable object changes accordingly.

In the Fortran standard, the allocation status of an allocatable object that is declared in the scope of a module is processor dependent if it does not have the **SAVE** attribute and was currently allocated when execution of a **RETURN** or **END** statement resulted in no executing scoping units referencing the module.

IBM Extension

In XL Fortran, the allocation status of such an object remains currently allocated.

End of IBM Extension

## Storage classes for variables

IBM Extension

**Note:** This section pertains only to storage for variables. Named constants and their subobjects have a storage class of *literal*.

### Fundamental storage classes

All variables are ultimately represented by one of five storage classes:

**Automatic** for variables in a procedure that will not be retained once the procedure ends. Variables reside in the stack storage area.

<b>Static</b>	for variables that retain memory throughout the program. Variables reside in the data storage area. Uninitialized variables reside in the bss storage area.
<b>Common</b>	for common block variables. If a common block variable is initialized, the whole block resides in the data storage area; otherwise, the whole block resides in the bss storage area.
<b>Controlled Automatic</b>	for automatic objects. Variables reside in the stack storage area. XL Fortran allocates storage on entry to the procedure and deallocates the storage when the procedure completes.
<b>Controlled</b>	for allocatable objects. Variables reside in the heap storage area. You must explicitly allocate and deallocate the storage.

## Secondary storage classes

None of the following storage classes own their own storage, but are associated with a fundamental storage class at run time.

**Pointee** is dependent on the value of the corresponding integer pointer.

### Reference parameter

is a dummy argument whose actual argument is passed to a procedure using the default passing method or **%REF**.

### Value parameter

is a dummy argument whose actual argument is passed by value to a procedure.

For details on passing methods, see “%VAL and %REF” on page 184.

## Storage class assignment

Variable names are assigned storage classes in one of the following ways:

### 1. Explicitly:

- Dummy arguments have an explicit storage class of reference parameter or value parameter. See “%VAL and %REF” on page 184 for more details.
- Pointee variables have an explicit storage class of pointee.
- Variables for which the **STATIC** attribute is explicitly specified have an explicit storage class of static.
- Variables for which the **AUTOMATIC** attribute is explicitly specified have an explicit storage class of automatic.
- Variables that appear in a **COMMON** block have an explicit storage class of common.
- Variables for which the **SAVE** attribute is explicitly specified have an explicit storage class of static, unless they also appear in a **COMMON** statement, in which case their storage class is common.
- Variables that appear in a **DATA** statement or are initialized in a type declaration statement have an explicit storage class of static, unless they also appear in a **COMMON** statement, in which case their storage class is common.
- Function result variables that are of type character or derived have the explicit storage class of reference parameter.
- Function result variables that do not have the **SAVE** or **STATIC** attribute have an explicit storage class of automatic.
- Automatic objects have an explicit storage class of controlled automatic.

- Allocatable objects have an explicit storage class of controlled.

A variable that does not satisfy any of the above, but that is equivalenced with a variable that has an explicit storage class, inherits that explicit storage class.

A variable that does not satisfy any of the above, and is not equivalenced with a variable that has an explicit storage class, has an explicit storage class of static if:

- A **SAVE** statement with no list exists in the scoping unit or,
- The variable is declared in the specification part of a main program.

## 2. Implicitly:

If a variable does not have an explicit storage class, it can be assigned an implicit storage class as follows:

- Variables whose names begin with a letter, dollar sign or underscore that appears in an **IMPLICIT STATIC** statement have a storage class of static.
- Variables whose names begin with a letter, dollar sign or underscore that appears in an **IMPLICIT AUTOMATIC** statement have a storage class of automatic.

In a given scoping unit, if a letter, dollar sign or underscore has not been specified in an **IMPLICIT STATIC** or **IMPLICIT AUTOMATIC** statement, the implicit storage class is the same as that in the host.

Variables declared in the specification part of a module are associated with the static storage class.

A variable that does not satisfy any of the above but that is equivalenced with a variable that has an implicit storage class, inherits that implicit storage class.

## 3. Default:

All other variables have the default storage class:

- Static, if you specified the **-qsave=all** compiler option.
- Static, for variables of derived type that have default initialization specified, and automatic otherwise if you specify the **-qsave=defaultinit** compiler option.
- Automatic, if you specified the **-qnosave** compiler option. This is the default setting.

See **-qsave** option in the *XL Fortran Compiler Reference* for details on the default settings with regard to the invocation commands.

End of IBM Extension

---

## Typeless literal constants

A typeless constant does not have an intrinsic type in XL Fortran. Hexadecimal, octal, binary, and Hollerith constants can be used in any situation where intrinsic literal constants are used, except as the length specification in a type declaration statement (although typeless constants can be used in a *type\_param\_value* in **CHARACTER** type declaration statements). The number of digits recognized in a hexadecimal, octal, or binary constant depends on the context in which the constant is used.

### Hexadecimal constants

The form of a hexadecimal constant is:



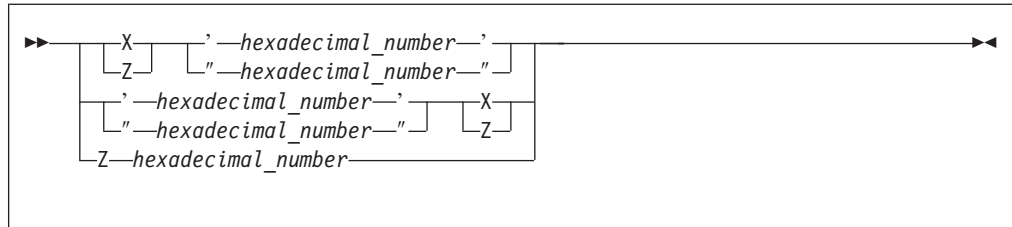

*hexadecimal\_number*

is a string composed of digits (0-9) and letters (A-F, a-f).  
Corresponding uppercase and lowercase letters are equivalent.

The *Znn...nn* form of a hexadecimal constant can only be used as a data initialization value delimited by slashes. If this form of a hexadecimal constant is the same string as the name of a constant you defined previously with the **PARAMETER** attribute, XL Fortran recognizes the string as the named constant.

If 2x hexadecimal digits are present, x bytes are represented.

See “Using typeless constants” on page 31 for information on how XL Fortran interprets the constant.

### Examples of hexadecimal constants

```
Z'0123456789ABCDEF'  
Z"FEDCBA9876543210"  
Z'0123456789aBcDeF'  
Z0123456789aBcDeF ! This form can only be used as an initialization value
```

### Octal constants

The form of an octal constant is:

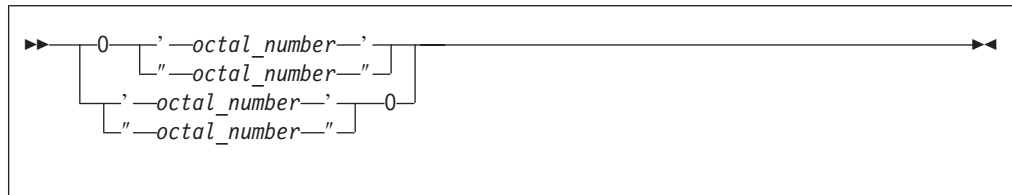

*octal\_number*

is a string composed of digits (0-7)

Because an octal digit represents 3 bits, and a data object represents a multiple of 8 bits, the octal constant may contain more bits than are needed by the data object. For example, an **INTEGER(2)** data object can be represented by a 6-digit octal constant if the leftmost digit is 0 or 1; an **INTEGER(4)** data object can be represented by an 11-digit constant if the leftmost digit is 0, 1, 2, or 3; an **INTEGER(8)** can be represented by a 22-digit constant if the leftmost digit is 0 or 1.

See “Using typeless constants” on page 31 for information on how the constant is interpreted by XL Fortran.

### Examples of octal constants

```
0'01234567'  
"01234567"0
```

## Binary constants

The form of a binary constant is:

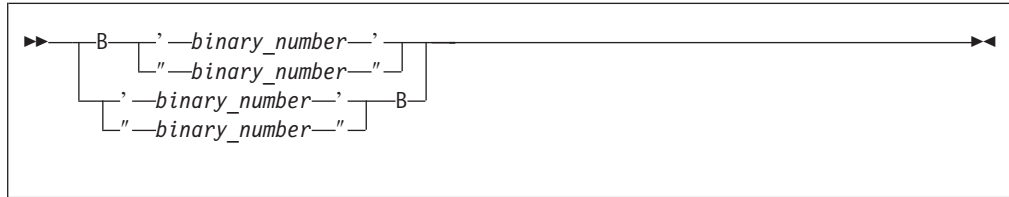

*binary\_number* is a string formed from the digits 0 and 1

If 8x binary digits are present, x bytes are represented.

See “Using typeless constants” on page 31 for information on how XL Fortran interprets the constant.

### Examples of binary constants

```
B"10101010"  
'10101010'B
```

## Hollerith constants

The form of a Hollerith constant is:

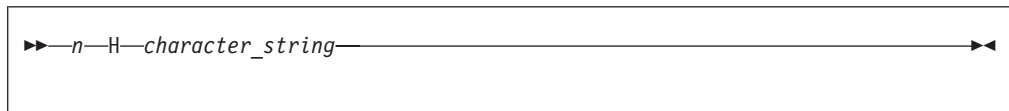

A Hollerith constant consists of a nonempty string of characters capable of representation in the processor and preceded by `nH`, where `n` is a positive unsigned integer constant representing the number of characters after the `H`. `n` cannot specify a kind type parameter. The number of characters in the string may be from 1 to 255.

**Note:** If you specify `nH` and fewer than `n` characters are specified after the `n`, any blanks that are used to extend the input line to the right margin are considered to be part of the Hollerith constant. A Hollerith constant can be continued on a continuation line. At least `n` characters must be available for the Hollerith constant.

XL Fortran also recognizes escape sequences in Hollerith constants, unless the `-qnoescape` compiler option is specified. If a Hollerith constant contains an escape sequence, `n` is the number of characters in the internal representation of the string, not the number of characters in the source string. (For example, `2H\""` represents a Hollerith constant for two double quotation marks.)

XL Fortran provides support for multibyte characters within character constants, Hollerith constants, `H` edit descriptors, character-string edit descriptors, and comments. This support is provided through the `-qmbcs` option. Assignment of a constant containing multibyte characters to a variable that is not large enough to hold the entire string may result in truncation within a multibyte character.

Support is also provided for Unicode characters and filenames. If the environment variable **LANG** is set to **UNIVERSAL** and the **-qmbcs** compiler option is specified, the compiler can read and write Unicode characters and filenames.

See “Using typeless constants” for information on how the constant is interpreted by XL Fortran.

## Using typeless constants

The data type and length of a typeless constant are determined by the context in which you use the typeless constant. XL Fortran does not convert the data type and length until you use them and context is understood.

- If you compile your program with the **-qctypless** compiler option, character initialization expressions follow the rules that apply to Hollerith constants.
- A typeless constant can assume only one of the intrinsic data types.
- When you use a typeless constant with an arithmetic or logical unary operator, the constant assumes a default integer type.
- When you use a typeless constant with an arithmetic, logical, or relational binary operator, the constant assumes the same data type as the other operand. If both operands are typeless constants, they assume a type of default integer unless both operands of a relational operator are Hollerith constants. In this case, they both assume a character data type.
- When you use a typeless constant in a concatenation operation, the constant assumes a character data type.
- When you use a typeless constant as the expression on the right-hand side of an assignment statement, the constant assumes the type of the variable on the left-hand side.
- When you use a typeless constant in a context that requires a specific data type, the constant assumes that data type.
- When you use a typeless constant as an initial value in a **DATA** statement, **STATIC** statement, or type declaration statement, or as the constant value of a named constant in a **PARAMETER** statement, or when the typeless constant is to be treated as any noncharacter type of data, the following rules apply:
  - If a hexadecimal, octal, or binary constant is smaller than the length expected, XL Fortran adds zeros on the left. If it is longer, the compiler truncates on the left.
  - If a Hollerith constant is smaller than the length expected, the compiler adds blanks on the right. If it is longer, the compiler truncates on the right.
  - If a typeless constant specifies the value of a named constant with a character data type having inherited length, the named constant has a length equal to the number of bytes specified by the typeless constant.
- When a typeless constant is treated as an object of type character (except when used as an initial value in a **DATA**, **STATIC**, type declaration, or component definition statement), the length is determined by the number of bytes represented by the typeless constant.
- When you use a typeless constant as part of a complex constant, the constant assumes the data type of the other part of the complex constant. If both parts are typeless constants, the constants assume the real data type with length sufficient to represent both typeless constants.
- When you use a typeless constant as an actual argument, the type of the corresponding dummy argument must be an intrinsic data type. The dummy argument must not be a procedure, pointer, array, object of derived type, or alternate return specifier.

- When you use a typeless constant as an actual argument, and:
  - The procedure reference is to a generic intrinsic procedure,
  - All of the arguments are typeless constants, and
  - There *is* a specific intrinsic procedure that has the same name as the generic procedure name,

the reference to the generic name will be resolved through the specific procedure.

- When you use a typeless constant as an actual argument, and:
  - The procedure reference is to a generic intrinsic procedure,
  - All of the arguments are typeless constants, and
  - There is *no* specific intrinsic procedure that has the same name as the generic procedure name,

the typeless constant is converted to default integer. If a specific intrinsic function takes integer arguments, the reference is resolved through that specific function. If there are no specific intrinsic functions, the reference is resolved through the generic function.

- When you use a typeless constant as an actual argument, and:
  - The procedure reference is to a generic intrinsic procedure, and
  - There is another argument specified that is not a typeless constant,

the typeless constant assumes the type of that argument. However, if you specify the compiler option **-qport=typ1ssarg**, the actual argument is converted to default integer. The selected specific intrinsic procedure is based on that type.

- When you use a typeless constant as an actual argument, and the procedure name is established to be generic but is not an intrinsic procedure, the generic procedure reference must resolve to only one specific procedure. The constant assumes the data type of the corresponding dummy argument of that specific procedure. For example:

```

INTERFACE SUB
  SUBROUTINE SUB1( A )
    REAL A
  END SUBROUTINE
  SUBROUTINE SUB2( A, B )
    REAL A, B
  END SUBROUTINE
  SUBROUTINE SUB3( I )
    INTEGER I
  END SUBROUTINE
END INTERFACE
CALL SUB('C0600000'X, '40066666'X) ! Resolves to SUB2

CALL SUB('00000000'X)           ! Invalid - ambiguous, may
                                ! resolve to either SUB1 or SUB3

```

- When you use a typeless constant as an actual argument, and the procedure name is established to be only specific, the constant assumes the data type of the corresponding dummy argument.
- When you use a typeless constant as an actual argument, and:
  - The procedure name has not been established to be either generic or specific, and
  - The constant has been passed by reference,

the constant assumes the default integer size but no data type, unless it is a Hollerith constant. The default for passing a Hollerith constant is the same as if it were a character actual argument. However, using the compiler option

**-qctyp1ss=arg** will cause a Hollerith constant to be passed as if it were an integer actual argument. See "Resolution of procedure references" on page 193 for more information about establishing a procedure name to be generic or specific.

- When you use a typeless constant as an actual argument, and:
  - The procedure name has not been established to be either generic or specific, and
  - The constant has been passed by value,

the constant is passed as if it were a default integer for hexadecimal, binary, and octal constants.

If the constant is a Hollerith constant and it is smaller than the size of a default integer, XL Fortran adds blanks on the right. If the constant is a Hollerith constant and it is larger than 8 bytes, XL Fortran truncates the rightmost Hollerith characters. See "Resolution of procedure references" on page 193 for more information about establishing a procedure name to be generic or specific.

- When you use a typeless constant in any other context, the constant assumes the default integer type, with the exception of Hollerith constants. Hollerith constants assume a character data type in the following situations:
  - An H edit descriptor
  - A relational operation with both operands being Hollerith constants
  - An input/output list
- If a typeless constant is to be treated as a default integer but the value cannot be represented within the value range for a default integer, the constant is promoted to a representable kind.
- A kind type parameter must not be replaced with a logical constant even if **-qintlog** is on, nor by a character constant even if **-qctyp1ss** is on, nor can it be a typeless constant.

### Examples of typeless constants in expressions

```
INT=B'1'           ! Binary constant is default integer
RL4=X'1'           ! Hexadecimal constant is default real
INT=INT + 0'1'     ! Octal constant is default integer
RL4=INT + B'1'     ! Binary constant is default integer
INT=RL4 + Z'1'     ! Hexadecimal constant is default real
ARRAY(0'1')=1.0    ! Octal constant is default integer

LOGICAL(8) LOG8
LOG8=B'1'          ! Binary constant is LOGICAL(8), LOG8 is .TRUE.
```



---

## Chapter 3. Intrinsic Data Types

Intrinsic types and their operations are predefined and always accessible. The two classes of intrinsic types are numeric and nonnumeric, with a number of types comprising each class.

Table 9. *Intrinsic Types*

Numeric Intrinsic Types	Nonnumeric Intrinsic Types
Integer	Logical
Real	Character
Complex	Vector <b>1</b>
Byte <b>1</b>	Byte <b>1</b>

### Notes:

1. IBM Extension.

XL Fortran also supports derived types, which are composite data types that can contain both intrinsic and derived types.

---

## Integer

---

### IBM Extension

The *Range of integer values* table contains the range of values that XL Fortran can represent using the integer data type.

Table 10. *Range of integer values*

Kind parameter	Range of values
1	-128 through 127
2	-32 768 through 32 767
4	-2 147 483 648 through 2 147 483 647
8	-9 223 372 036 854 775 808 through 9 223 372 036 854 775 807

XL Fortran sets the default kind type parameter to 4. The kind type parameter is equivalent to the byte size for integer values. Use the **-qintsize** compiler option to change the default integer size to 2, 4, or 8 bytes. Note that the **-qintsize** option similarly affects the default logical size.

---

### End of IBM Extension

The integer type specifier must include the **INTEGER** keyword.

The form of a signed integer literal constant is:

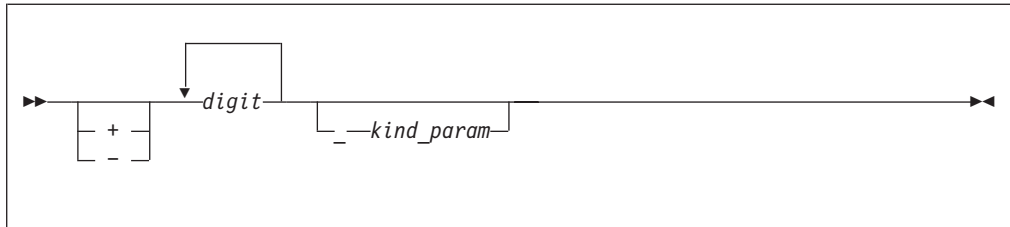

*kind\_param*  
is either a *digit-string* or a *scalar-int-constant-name*

A signed integer literal constant has an optional sign, followed by a string of decimal digits containing no decimal point and expressing a whole number, optionally followed by a kind type parameter. A signed, integer literal constant can be positive, zero, or negative. If unsigned and nonzero, the constant is assumed to be positive.

If *kind\_param* is specified, the magnitude of the literal constant must be representable within the value range permitted by that *kind\_param*.

**IBM Extension**

If no *kind\_param* is specified in XL Fortran, and the magnitude of the constant cannot be represented as a default integer, the constant is promoted to a kind in which it can be represented.

XL Fortran represents integers internally in two's-complement notation, where the leftmost bit is the sign of the number.

**End of IBM Extension**

**Example of integer constants**

```
0                ! has default integer size
-173_2          ! 2-byte constant
9223372036854775807 ! Kind type parameter is promoted to 8
```

## Real

**IBM Extension**

The following table shows the range of values that XL Fortran can represent with the real data type:

Kind Parameter	Approximate Absolute Nonzero Minimum	Approximate Absolute Maximum	Approximate Precision (decimal digits)
4	1.175494E-38	3.402823E+38	7
8	2.225074D-308	1.797693D+308	15
16	2.225074Q-308	1.797693Q+308	31

XL Fortran sets the default kind type parameter to 4. The kind type parameter is equivalent to the byte size for real values. Use the **-qrealsize** compiler option to change the default real size to 4 or 8 bytes. Note that the **-qrealsize** option affects the default complex size.



XL Fortran represents **REAL(4)** and **REAL(8)** numbers internally in the ANSI/IEEE binary floating-point format, which consists of a sign bit (s), a biased exponent (e), and a fraction (f). The **REAL(16)** representation is based on the **REAL(8)** format.

```

REAL(4)
Bit no. 0....|....1....|....2....|....3.
         seeeeeeeffffffffffffffffffff

REAL(8)
Bit no. 0....|....1....|....2....|....3....|....4....|....5....|....6...
         seeeeeeeeffffffffffffffffffffff

REAL(16)
Bit no. 0....|....1....|....2....|....3....|....4....|....5....|....6...
         seeeeeeeeffffffffffffffffffffff
Bit no. .|....7....|....8....|....9....|....0....|....1....|....2....|.
         seeeeeeeeffffffffffffff

```

The definition of intrinsic **RANGE** is  $\text{INT}(\text{MIN}(\text{LOG}_{10}(\text{HUGE}(X)), -\text{LOG}_{10}(\text{TINY}(X))))$ .

For **REAL(8)** numbers, the **HUGE** intrinsic returns 0x7FEFFFFFFFFFFFF and the **TINY** intrinsic returns 0x0010000000000000. As a result, we have  $\text{INT}(\text{MIN}(308.254715559916747, 307.652655568588784))$ , and therefore the range is 307. Note that the LOG scale is not symmetric on both ends of the exponent.

The IBM format of **REAL(16)** numbers is composed of two **REAL(8)** numbers of different magnitudes that do not overlap. That is, the binary exponents differ by at least the number of fraction bits in a **REAL(8)**.

For **REAL(16)**, the **RANGE** intrinsic returns the range of the numbers that have both **REAL(8)** numbers normalized. Consequently, for **REAL(16)** numbers, the **HUGE** intrinsic returns 0x7FEFFFFFFFFFFFF7C9FFFFFFFFFFFF and the **TINY** intrinsic returns 0x03600000000000000000000000000000. As a result, we have  $\text{INT}(\text{MIN}(308.254715559916743898886862819788120, 291.69806579839777816211298898803388))$ , where the range is 291.

308 is the lowest or highest exponent that can be represented in the **REAL(8)** or **REAL(16)** numbers.

This ANSI/IEEE binary floating-point format also provides representations for +infinity, -infinity, and NaN (not-a-number) values. A NaN can be further classified as a quiet NaN (NaNQ) or a signaling NaN (NaNS). See Implementation details of XL Fortran floating-point processing for details on the internal representation of NaN values.

|----- End of IBM Extension -----|

A real type specifier must include either the **REAL** keyword or the **DOUBLE PRECISION** keyword. The precision of **DOUBLE PRECISION** values is twice that of default real values. See “REAL” on page 435 and “DOUBLE PRECISION” on page 329 for details on declaring entities of type real.

The forms of a real literal constant are:

- A basic real constant optionally followed by a kind type parameter
- A basic real constant followed by an exponent and an optional kind type parameter
- An integer constant (with no *kind\_param*) followed by an exponent and an optional kind type parameter

A basic real constant has, in order, an optional sign, an integer part, a decimal point, and a fractional part. Both the integer part and fractional part are strings of digits; you can omit either of these parts, but not both. You can write a basic real constant with more digits than XL Fortran will use to approximate the value of the constant. XL Fortran interprets a basic real constant as a decimal number.

The form of a real constant is:

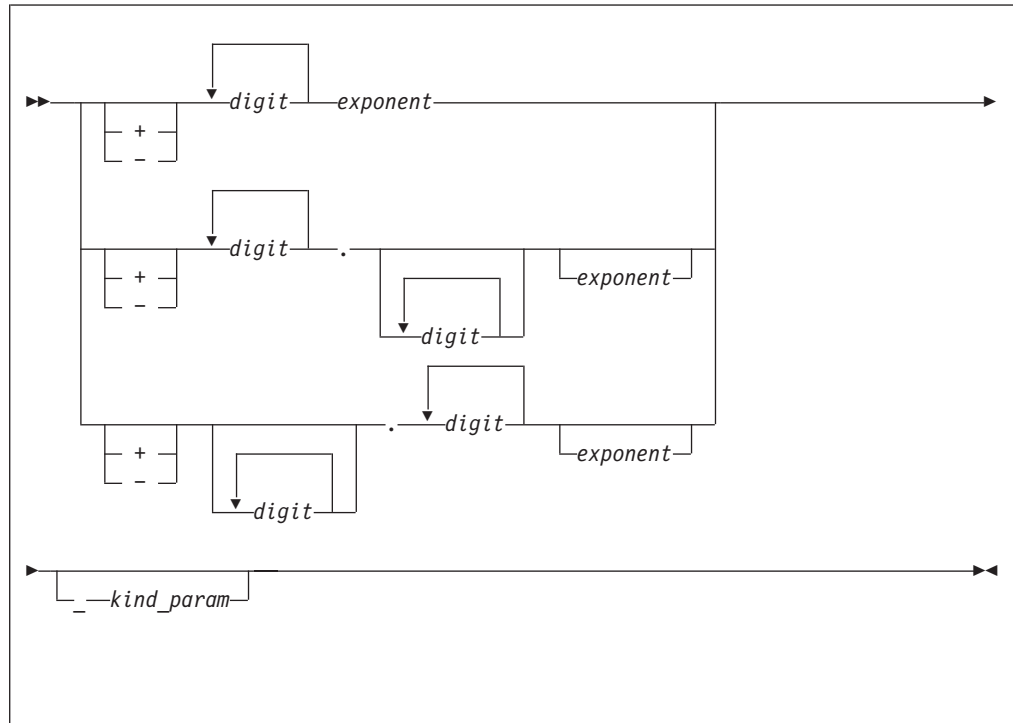

*exponent*

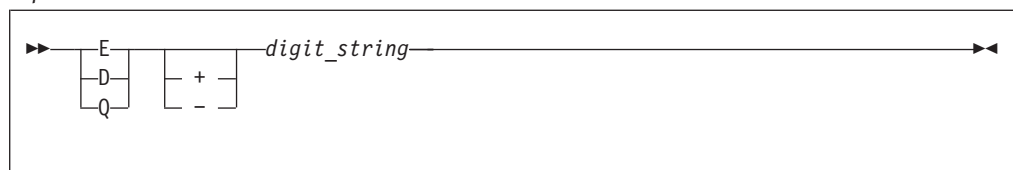

*kind\_param* is either a *digit-string* or a *scalar-int-constant-name*

*digit\_string* denotes a power of 10. **E** specifies a constant of type default real, unless you also include a *kind\_param*, which overrides the default type. **D** specifies a constant of type default **DOUBLE PRECISION**. **IBM** **Q** specifies a constant of type **REAL(16)** in XL Fortran. **IBM**

If both *exponent* and *kind\_param* are specified, the exponent letter must be **E**. If **D** or **Q** is specified, *kind\_param* must not be specified.

A real literal constant that is specified without an exponent and a kind type parameter is of type default real.

#### Example of integer constants

+0.

+5.432E02\_16 !543.2 in 16-byte representation

## Complex

A complex type specifier must include one of the following:

- The **COMPLEX** keyword.
-  The **DOUBLE COMPLEX** keyword. 

See “COMPLEX” on page 307 and “DOUBLE COMPLEX” on page 326 for details on declaring entities of type complex.

### IBM Extension

The following table shows the corresponding values for the kind type parameter and the length specification when the complex type specifier has the **COMPLEX** keyword:

Kind Type Parameter <i>i</i> COMPLEX( <i>i</i> )	Length Specification <i>j</i> COMPLEX* <i>j</i>
4	8
8	16
16	32

In XL Fortran, the kind type parameter specifies the precision of each part of the complex entity, while the length specification specifies the length of the whole complex entity.

### End of IBM Extension

The kind of a complex constant is determined by the kind of the constants in the real and imaginary parts.

The precision of **DOUBLE COMPLEX** values is twice that of default complex values.

Scalar values of type complex can be formed using complex constructors. The form of a complex constructor is:



A complex literal constant is a complex constructor where each expression is a pair of initialization expressions. Variables and expressions can be used in each part of the complex constructor as an XL Fortran extension.

In Fortran 95 you are only allowed to use a single signed integer, or real literal constant in each part of the complex constructor. In Fortran 2003, you can also use a named constant.

If both parts of the literal constant are of type real, the kind type parameter of the literal constant is the kind parameter of the part with the greater precision, and the kind type parameter of the part with lower precision is converted to that of the other part.

If both parts are of type integer, they are each converted to type default real. If one part is of type integer and the other is of type real, the integer is converted to type real with the precision of the real part.

See “COMPLEX” on page 307 and “DOUBLE COMPLEX” on page 326 for details on declaring entities of type complex.

Each part of a complex number has the same internal representation as a real number with the same kind type parameter.

#### Examples of complex constants

```
(3_2,-1.86) ! Integer constant 3 is converted to default real
             ! for constant 3.0.
(45Q6,6D45) ! The imaginary part is converted to extended
             ! precision 6.Q45.
(1+1,2+2)   ! Use of constant expressions. Both parts are
             ! converted to default real.
```

---

## Logical

### IBM Extension

The following table shows the values that XL Fortran can represent using the logical data type:

Kind parameter	Values	Internal (hex) Representation
1	.TRUE. .FALSE.	01 00
2	.TRUE. .FALSE.	0001 0000
4	.TRUE. .FALSE.	00000001 00000000
8	.TRUE. .FALSE.	0000000000000001 0000000000000000

**Note:** Any internal representation other than 1 for .TRUE. and 0 for .FALSE. is undefined.

XL Fortran sets the default kind type parameter to 4. The kind type parameter is equivalent to the byte size for logical values. Use the **-qintsize** compiler option to change the default logical size to 2, 4, or 8 bytes. Note that the **-qintsize** option similarly affects the default integer size. Use **-qintlog** to mix integer and logical data entities in expressions and statements.

The **-qport=clogicals** option allows you to instruct the compiler to treat all nonzero integers used in logical expressions as TRUE. In order to use the **-qport=clogicals** option, you must also specify the **-qintlog** option.

End of IBM Extension



*character\_string* consists of any characters capable of representation in XL Fortran, except the new-line character, because it is interpreted as the end of the source line. The delimiting apostrophes (') or double quotation marks (") are not part of the data represented by the constant. Blanks embedded between these delimiters are significant.

If a string is delimited by apostrophes, you can represent an apostrophe within the string with two consecutive apostrophes (without intervening blanks). If a string is delimited by double quotation marks, you can represent a double quotation mark within the string with two consecutive double quotation marks (without intervening blanks). The two consecutive apostrophes or double quotation marks will be treated as one character.

You can place a double quotation mark within a character literal constant delimited by apostrophes to represent a double quotation mark, and an apostrophe character within a character constant delimited by double quotation marks to represent a single apostrophe.

The length of a character literal constant is the number of characters between the delimiters, except that each pair of consecutive apostrophes or double quotation marks counts as one character.

A zero-length character object uses no storage.

---

**IBM Extension**

---

In XL Fortran each character object requires 1 byte of storage.

For compatibility with C language usage, XL Fortran recognizes the following escape sequences in character strings:

Escape	Meaning
\b	Backspace
\f	Form feed
\n	New-line
\r	New-line
\t	Tab
\0	Null
\'	Apostrophe (does not terminate a string)
\"	Double quotation mark (does not terminate a string)
\\	Backslash
\x	x, where x is any other character

To ensure that scalar character initialization expressions in procedure references are terminated with null characters (\0) for C compatibility, use the **-qnullterm** compiler option. (See **-qnullterm** option in the *XL Fortran Compiler Reference* for details and exceptions).

All escape sequences represent a single character.

End of IBM Extension

If you do not want these escape sequences treated as a single character, specify the **-qnoescape** compiler option. (See **-qescape** option in the *XL Fortran Compiler Reference*.) The backslash will have no special significance.

The maximum length of a character literal constant depends on the maximum number of characters allowed in a statement.

IBM Extension

If you specify the **-qctyp1ss** compiler option, character constant expressions are treated as if they are Hollerith constants. See “Hollerith constants” on page 30 for information on Hollerith constants. For information on the **-qctyp1ss** compiler option, see **-qctyp1ss** Option in the *XL Fortran Compiler Reference*

XL Fortran supports multibyte characters within character literal constants, Hollerith constants, **H** edit descriptors, character-string edit descriptors, and comments through the **-qmbcs** compiler option.

Support is also provided for Unicode characters and filenames. If the environment variable **LANG** is set to **UNIVERSAL** and the **-qmbcs** compiler option is specified, the compiler can read and write Unicode characters and filenames. See the *XL Fortran Compiler Reference* for more information.

End of IBM Extension

## Examples of character constants

### Example 1:

```
' ' ! Zero-length character constant.
```

### Example 2:

```
1_"ABCDEFGHJIJ" ! Character constant of length 10, with kind 1.
```

IBM Extension

### Example 3:

```
'\"2\"'\A567\\' ! Character constant of length 10 "2'A567\"'.
```

End of IBM Extension

## Character substrings

A character substring is a contiguous portion of a character string (called a parent string), which is a scalar variable name, scalar constant, scalar structure component, or array element. A character substring is identified by a substring reference whose form is:

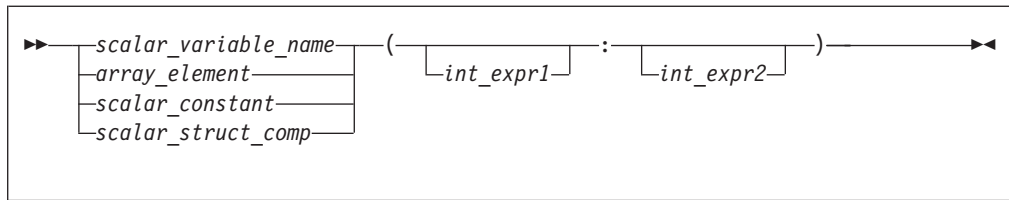

*int\_expr1* and *int\_expr2*

specify the leftmost character position and rightmost character position, respectively, of the substring. Each is a scalar integer expression called a substring expression.

The length of a character substring is the result of the evaluation of  $\text{MAX}(int\_expr2 - int\_expr1 + 1, 0)$ .

If *int\_expr1* is less than or equal to *int\_expr2*, their values must be such that:

- $1 \leq int\_expr1 \leq int\_expr2 \leq length$

where *length* is the length of the parent string. If *int\_expr1* is omitted, its default value is 1. If *int\_expr2* is omitted, its default value is *length*.

#### IBM Extension

FORTRAN 77 does not allow character substrings of length 0. Fortran 90 and up does allow these substrings. To perform compile-time checking on substring bounds in accordance with FORTRAN 77 rules, use the **-qnozerosize** compiler option. For Fortran 90 compliance, use **-qzerosize**. To perform run-time checking on substring bounds, use both the **-qcheck** option and the **-qzerosize** (or **-qnozerosize**) option. (See the *XL Fortran Compiler Reference* for more information.)

#### End of IBM Extension

A substring of an array section is treated differently. See “Array sections and substring ranges” on page 85.

### Examples of character substrings

```

CHARACTER(8) ABC, X, Y, Z
ABC = 'ABCDEFGHJKLMN'(1:8)    ! Substring of a constant
X = ABC(3:5)                  ! X = 'CDE'
Y = ABC(-1:6)                 ! Not allowed in either FORTRAN 77 or Fortran 90
Z = ABC(6:-1)                 ! Z = '' valid only in Fortran 90
  
```

## Byte

#### IBM Extension

The byte type specifier is the **BYTE** keyword in XL Fortran. See “BYTE” on page 287 for details on declaring entities of type byte.

The **BYTE** intrinsic data type does not have its own literal constant form. A **BYTE** data object is treated as an **INTEGER(1)**, **LOGICAL(1)**, or **CHARACTER(1)** data object, depending on how it is used.

#### End of IBM Extension



## Vector

### IBM Extension

An entity you declare using the **VECTOR** keyword as part of a type declaration statement is of a vector type. An entity of a vector type has the same type as another entity if both entities are vectors that contain elements of the same type and kind. Otherwise, the two entities are of different types. You must not include vector objects in formatted I/O.

A vector type can be any of the following:

- A **PIXEL** vector.
- An **INTEGER** vector with elements that have a kind type parameter of 1, 2 or 4.
- An **UNSIGNED** vector with elements that have a kind type parameter of 1, 2, or 4.
- A **REAL** vector with elements that have a kind parameter of 4.

A vector must only be declared if your **-qarch** setting specifies a VMX-enabled architecture and you compile with **-qenablevmx**.

A vector is always a 16-byte entity. Consequently, an **INTEGER(1)** or **UNSIGNED(1)** vector contains 16 elements. **INTEGER(2)**, **UNSIGNED(2)**, or **PIXEL**, vectors contain 8 elements, while **INTEGER(4)**, **UNSIGNED(4)**, or **REAL(4)** vectors contain 4 elements.

If the kind type parameter is not specified for elements of **INTEGER**, **UNSIGNED** and **REAL** vectors, these elements have the default kind.

Vectors must be aligned on a 16-byte boundary. XL Fortran automatically aligns vectors to 16 bytes, except in the following cases, where:

- The vector is a component of a sequence type or a record structure.
- The vector is a component of a derived type that has the **BIND** attribute and you compile with the **-qalign=bindc=packed** or **-qalign=bindc=bit\_packed** options. This aligns the vector to a one-byte boundary.
- The vector is a member of a common block.
- The vector is storage associated with a member of a common block that does not have a 16-byte boundary alignment.

Use the *Vector Interlanguage Interoperability* table to determine the corresponding XL C/C++ vector type when passing vectors between XL C/C++ and XL Fortran.

Table 11. Vector interlanguage interoperability

XL Fortran vector type	XL C/C++ vector type
<b>VECTOR</b> ( <b>INTEGER</b> (1))	vector signed char
<b>VECTOR</b> ( <b>INTEGER</b> (2))	vector signed short
<b>VECTOR</b> ( <b>INTEGER</b> (4))	vector signed int, vector signed long
<b>VECTOR</b> ( <b>PIXEL</b> )	vector pixel
<b>VECTOR</b> ( <b>REAL</b> (4))	vector float
<b>VECTOR</b> ( <b>UNSIGNED</b> (1))	vector unsigned char
<b>VECTOR</b> ( <b>UNSIGNED</b> (2))	vector unsigned short

Table 11. Vector interlanguage interoperability (continued)

XL Fortran vector type	XL C/C++ vector type
VECTOR(UNSIGNED(4))	vector unsigned int, vector unsigned long

End of IBM Extension

## Pixel

IBM Extension

The **PIXEL** keyword specifies the pixel type. A pixel is a two-byte entity that the compiler interprets in four parts. The first part consists of one bit. The remaining three parts consist of 5 bits each. Pixel literals are not supported. You must specify a pixel only as part of a vector declaration.

End of IBM Extension

## Unsigned

IBM Extension

The **UNSIGNED** keyword specifies the unsigned integer type. Use the **-qintsize** compiler option to change the default integer size to 2, 4, or 8 bytes. The default kind type parameter is 4. Unsigned integer literals are not supported. You must specify the unsigned integer type only as part of a vector declaration.

End of IBM Extension

---

## Chapter 4. Derived Types

A derived type is a composite data type that can contain both intrinsic and derived data types. You can define a derived type using type definition. This definition specifies the name of the derived type as well as type components and procedures. In Fortran 95, a type definition must have at least one component and must not contain procedures. In Fortran 2003, a type definition can have zero or more components, and zero or more procedures. The components of a derived type can be of any intrinsic type and can be of a previously defined derived type. These components can be both direct and ultimate.

Direct components are:

- The components of that type
- The direct components of a derived type component without the **F2003** **ALLOCATABLE** or **F2003** **POINTER** attributes

Ultimate components are:

- Components of intrinsic data type
- Components with the **F2003** **ALLOCATABLE** **F2003** or **POINTER** attribute
- The ultimate components of a derived type component without the **F2003** **ALLOCATABLE** **F2003** or **POINTER** attribute

The type of a pointer component can be the same as the type containing the component. Within a derived type, the names of components and procedures must be unique, although the names can be the same as names outside the scope of the derived type definition. Components that you declare to be type character must have length specifications that are constant specification expressions.

Fortran 2003 also allows components of type character to have deferred length if the component also has the **F2003** **ALLOCATABLE** **F2003** or **POINTER** attribute.

Nonpointer, nonallocatable array components must be declared with constant dimension declarators. You must declare pointer and allocatable array components with a *deferred\_shape\_spec\_list*.

A component of a derived type must not appear as an input/output list item if any ultimate component of the object cannot be accessed by the scoping unit of the input/output statement, **F2003** unless a user-defined input/output procedure processes the derived-type object. **F2003** A derived-type object must not appear in a data transfer statement if the object has a component that is a pointer or allocatable, unless a user-defined input/output procedure processes the object.

**F2003**

## Syntax of a derived type

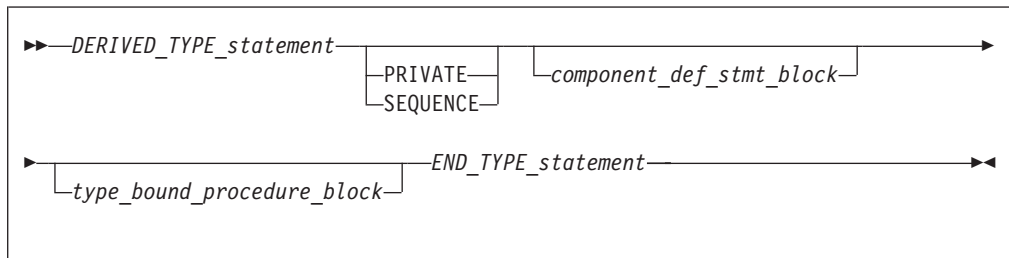

### *DERIVED\_TYPE\_statement*

See “Derived Type” on page 320 for syntax details.

### **PRIVATE**

Specifies that default accessibility for the components of the derived type are private. You can only specify one **PRIVATE** component statement for a given derived type.

### **SEQUENCE**

You can only specify one **SEQUENCE** statement. For details see “SEQUENCE” on page 448

### *component\_def\_stmt\_block*

Consists of one or more type declaration or procedure declaration statements to define the components of the derived type. The type declaration statements can specify only the **DIMENSION**, **F2003** **ALLOCATABLE**, **PRIVATE**, **PUBLIC** **F2003**, and **POINTER** attributes. See **TYPE** and **CLASS** for details on declaring components of a specified derived type.

### Fortran 95

In addition, you can specify a default initialization for each component in the definition of a derived type.

### End of Fortran 95

### Fortran 2003

### *type\_bound\_procedure\_block*

Consists of a **CONTAINS** statement, followed optionally by a **PRIVATE** statement, and one or more procedure binding statements. **PRIVATE** specifies that the default accessibility for the derived type bindings are private, and you can only specify one **PRIVATE** binding statement for a given derived type. See “CONTAINS” on page 312 and “Type-bound procedures” on page 58 for detailed syntax and additional information.

### End of Fortran 2003

### **END\_TYPE\_statement**

Optionally contains the same *type\_name* as specified on the **TYPE** statement. For more information see “END TYPE” on page 341

---

## Component and procedure accessibility

The default accessibility of a component of a derived type is **PUBLIC**. The **PRIVATE** statement changes that default accessibility to private. You can only specify a **PRIVATE** statement on a derived type definition if that definition is within the specification part of a module.

If you define a type as **PRIVATE**, the following are accessible only within the defining module:

- The type name.
- Structure constructors for the type.
- Any procedure that has a dummy argument or function result of the type.

You can use the **PRIVATE** or **PUBLIC** attribute on a component of the derived type to override the default accessibility. You can only specify the **PRIVATE** or **PUBLIC** attribute on a component if the type definition is within the specification part of a module. If a component is private, the component name is accessible only with the module containing the derived type definition, even if the derived type itself is public.

---

### Fortran 2003

The default accessibility of a procedure binding is **PUBLIC**. The **PRIVATE** statement changes that default accessibility to private. You can use the **PRIVATE** or **PUBLIC** attribute on a procedure binding to override the default accessibility. If the procedure binding is private, it is accessible only within the defining module, even if the derived type itself is public.

End of Fortran 2003

---

## Default initialization

---

### Fortran 95

You can specify default initialization for a nonpointer using an equal sign followed by an initialization expression, or by enclosing an *initial\_value\_list* in slashes. Enclosing an *initial\_value\_list* in slashes can apply to components in a standard derived type declaration, or those within a record structure.

For pointer default initialization, use an arrow ( $=>$ ) and then a reference to the **NULL** intrinsic with no arguments.

A data object specified with default initialization in the type definition is a named data object with these characteristics:

1. The object is a derived type specifying default initialization for any of its direct components.
2. The object does not have the **F2003** **ALLOCATABLE** **F2003** attribute.
3. The object is not use or host associated.

---

### IBM Extension

4. The object is not a pointee.

End of IBM Extension

A default initialization for a nonpointer, nonallocatable component takes precedence over any default initialization appearing for any direct component of the same type.

If a dummy argument with **INTENT(OUT)** is a derived type with default initialization, the dummy argument must not be an assumed-size array. If you specify that a nonpointer object has default initialization in a type definition, you must not initialize that object with a **DATA** statement.

**IBM Extension**

You can use a derived type data object with default initialization in a common block as an IBM extension. The **-qsave=defaultinit** option causes default initialization to imply the **SAVE** attribute.

**End of IBM Extension**

Unlike explicit initialization, it is not necessary for a data object to have the **SAVE** attribute for component default initialization to have an effect. You can specify default initialization for some components of a derived type, but it is not necessary for every component.

You can specify default initialization for a storage unit that is storage associated. However, the objects or subobjects supplying the default initialization must be of the same type. The objects or subobjects must also have the same type parameters and supply the same value for that storage unit.

A direct component receives an initial value if you specify default initialization on the corresponding component definition in the type definition, regardless of the accessibility of that component.

For data objects that can undergo default initialization, their nonpointer components are either initially undefined, or their corresponding default initialization expressions define them. Their pointer components with default initialization are initially disassociated, and all other pointer components are initially undefined.

If you specify default initialization for a variable, and that variable has static storage class, then default initialization occurs for that variable when your application executes.

If you specify default initialization for a variable, and it is a function result, an **INTENT(OUT)** dummy argument, or a local variable without the **SAVE** attribute, then default initialization occurs when the procedure containing the variable's declaration executes.

Allocation of an object of a derived type in which you specify default initialization for a component causes the component to:

- Become defined, if the component is a nonpointer
- Become disassociated, if the component is a pointer.

In a subprogram with an **ENTRY** statement, default initialization occurs only for the dummy arguments that appear in the argument list of the procedure name the **ENTRY** statement references. If a dummy argument has the **OPTIONAL** attribute, default initialization occurs only if that dummy argument is actually present.

Module data objects of derived type with default initialization must have the **SAVE** attribute to be a candidate for default initialization.

End of Fortran 95

---

## Sequence derived types

By default, the order of derived type component definitions does not imply a storage sequence. However, if you include a **SEQUENCE** statement, the derived type becomes a sequence derived type. For a sequence derived type, the order of the components specifies a storage sequence for objects you declare with this derived type. If a component of a sequence derived type is of a derived type, that derived type must also be a sequence derived type.

### Attention:

Using sequence derived types can lead to misaligned data, which can adversely affect the performance of your application. Use with discretion.

---

## Extensible derived types

Fortran 2003

An extensible type is a nonsequence noninteroperable derived type from which you can extend new types. You cannot use record structure syntax to define an extensible type. You can further classify an extensible type to be one or more of the following:

### Base type

Extends only itself and not another type.

### Extended type

Extends not only itself, but all types for which its parent type is an extension.

### Parent type

Provides components and procedure bindings to all types that extend from that type. A parent type is the extensible type from which an extended type is derived

You define an extended type with the **EXTENDS** attribute. The **EXTENDS** attribute specification includes the name of the parent type. For more information on specifying the **EXTENDS** attribute see “Derived Type” on page 320.

An extended type includes all components and nonfinal procedure bindings of its parent type. The extended type inherits these components and bindings from the parent type.

The extended type also inherits inaccessible components and bindings from the parent type. These components remain inaccessible in the extended type. A private entity is inaccessible if the type that you extend is accessed through use association.

A base type is not required to have any components or bindings. An extended type is not required to have more components or bindings than the parent type.

An extended type has a scalar, nonpointer, nonallocatable, parent component with the same type as the parent. The name of this component is identical to the name of the parent type, and has the same accessibility.

A component declared in an extended type cannot have the same name as any component of the parent type.

### Example of an extended type

```
TYPE :: POINT ! A base type
  REAL :: X, Y
END TYPE POINT

TYPE, EXTENDS(POINT) :: COLOR_POINT ! An extension of TYPE(POINT)
  INTEGER :: COLOR ! Components X and Y, and component name
END TYPE COLOR_POINT ! POINT, inherited from parent
```

In the example, the type `COLOR_POINT` inherits the components `X` and `Y` from parent type `POINT`. The components retain all of the attributes they have in the parent type. You can declare additional components and procedure bindings in the derived type definition of the extended type. In the example of an extensible type, the type `COLOR_POINT` has one additional component, `COLOR`. The type `POINT` is a nonsequence type that is not an extension of another type and therefore a base type. The type `COLOR_POINT` is an extended type, whose parent type is `POINT`.

`COLOR_POINT` has a parent component `POINT`. The parent component, `POINT`, is a structure with the components `X` and `Y`. Components of the parent are inheritance associated with the corresponding components inherited from the parent type. An ancestor component of a type is the parent component of the type or an ancestor component of the parent component. The ancestor component of `COLOR_POINT` is the parent component `POINT`.

End of Fortran 2003

---

## Abstract types and deferred bindings

Fortran 2003

An abstract type is a type with the **ABSTRACT** attribute. A nonpolymorphic object must not be declared with an abstract type. A polymorphic object cannot be allocated with a dynamic abstract type.

A binding with the **DEFERRED** attribute is a deferred binding. A deferred binding defers the implementation of a procedure to extensions of the type. You can specify a deferred binding only in an abstract type definition. The dynamic type of an object cannot be abstract. Therefore, a deferred binding cannot be invoked. An extension of an abstract type does not have to be abstract if that extension has no deferred bindings.

If a type definition contains or inherits a deferred binding, the **ABSTRACT** attribute must appear. If **ABSTRACT** appears, the type must be extensible.

### Example of an abstract type

```
TYPE, ABSTRACT :: FILE_HANDLE
  CONTAINS
  PROCEDURE(OPEN_FILE), DEFERRED, PASS(HANDLE) :: OPEN
```



```

...
END TYPE

INTERFACE
SUBROUTINE OPEN_FILE(HANDLE)
  CLASS(FILE_HANDLE), INTENT(IN):: HANDLE
END SUBROUTINE OPEN_FILE
END INTERFACE

```

End of Fortran 2003

## Structure components

Structure components can be of any explicit type, including derived type. Procedure pointers can also be structure components.

**Note:** The case in which a structure component has a subobject that is an array or array section requires some background information from “Array sections” on page 82, and is explained in “Array sections and structure components” on page 86. The following rules for scalar structure components apply also to structure components that have array subobjects.

You can refer to a specific structure component using a *component designator*. A scalar component designator has the following syntax:

*scalar\_struct\_comp*:

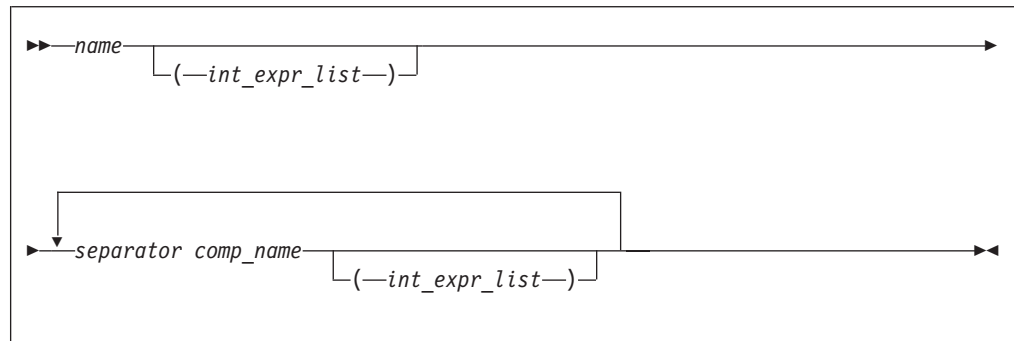

*name* is the name of an object of derived type

*comp\_name*  
is the name of a derived-type component

*int\_expr*  
is a scalar integer or real expression called a subscript expression

*separator*  
is % or IBM . IBM

The structure component has the same type, type parameters, and **POINTER** attribute (if any) as the right-most *comp\_name*. It inherits any **INTENT**, **TARGET**, and **PARAMETER** attributes from the parent object.

### Notes:

1. Each *comp\_name* must be a component of the immediately preceding *name* or *comp\_name*.
2. The *name* and each *comp\_name*, except the right-most, must be of derived type.

3. The number of subscript expressions in any *int\_expr\_list* must equal the rank of the preceding *name* or *comp\_name*.
4. If *name* or any *comp\_name* is the name of an array, it must have an *int\_expr\_list*.
5. F2003 If the declared type of the rightmost *comp\_name* is of abstract type, the structure component must be polymorphic. F2003
6. The rightmost *comp\_name* must be scalar.

In namelist formatting, a separator must be a percent sign.

If an expression has a form that could be interpreted either as a structure component using periods as separators or as a binary operation, and an operator with that name is accessible in the scoping unit, XL Fortran will treat the expression as a binary operation. If that is not the interpretation you intended, you should use the percent sign to dereference the parts, or, in free source form, insert white space between the periods and the *comp\_name*.

## Examples of references to structure components

### Example 1: Ambiguous use of a period as separator

```

MODULE MOD
  STRUCTURE /S1/
    STRUCTURE /S2/ BLUE
    INTEGER I
  END STRUCTURE
END STRUCTURE
INTERFACE OPERATOR(,BLUE.)
  MODULE PROCEDURE BLUE
END INTERFACE
CONTAINS
  INTEGER FUNCTION BLUE(R1, I)
    RECORD /S1/ R1
    INTENT(IN) :: R1
    INTEGER, INTENT(IN) :: I
    BLUE = R1%BLUE%I + I
  END FUNCTION BLUE
END MODULE MOD

PROGRAM P
  USE MOD
  RECORD /S1/ R1
  R1%BLUE%I = 17
  I = 13
  PRINT *, R1.BLUE.I ! Calls BLUE(R1,I) - prints 30
  PRINT *, R1%BLUE%I ! Prints 17
END PROGRAM P

```

### Example 2: Mix of separators

```

STRUCTURE /S1/
  INTEGER I
END STRUCTURE
STRUCTURE /S2/
  RECORD /S1/ C
END STRUCTURE
RECORD /S2/ R
R.C%I = 17 ! OK
R%C.I = 3 ! OK
R.C.I = 19 ! OK
END

```

### Example 3: Percent and period work for any derived types

```

STRUCTURE /S/
  INTEGER I, J
END STRUCTURE
TYPE DT
  INTEGER I, J
END TYPE DT
RECORD /S/ R1
TYPE(DT) :: R2
R1.I = 17; R1%J = 13
R2.I = 19; R2%J = 11
END

```

## Allocatable components

### Fortran 2003

Allocatable components are defined as ultimate components just as pointer components are. This is because the value (if any) is stored separately from the rest of the structure, and this storage does not exist (because the object is unallocated) when the structure is created. As with ultimate pointer components, variables containing ultimate allocatable components are forbidden from appearing directly in input/output lists, unless the variable is processed by a user-defined derived type input/output procedure.

As with allocatable arrays, allocatable components are forbidden from storage association contexts. So, any variable containing an ultimate, allocatable component cannot appear in **COMMON** or **EQUIVALENCE**. However, allocatable components are permitted in **SEQUENCE** types, which allows the same type to be defined separately in more than one scoping unit.

Deallocation of a variable containing an ultimate allocatable component automatically deallocates all such components of the variable that are currently allocated.

In a structure constructor for a derived type containing an allocatable component, the expression corresponding to the allocatable component must be one of the following:

- A reference to the intrinsic function **NULL** with no argument. The allocatable component receives the allocation status of not currently allocated
- A variable that is itself allocatable. The allocatable component receives the allocation status of the variable and, if it is allocated, the value of the variable. If the variable is an array that is allocated, the allocatable component also has the bounds of the variable.
- Any other expression. The allocatable component receives the allocation status of currently allocated with the same value as the expression. If the expression is an array, the allocatable component will have the same bounds.

For intrinsic assignment of those objects of a derived type containing an allocatable component, the allocatable component of the variable on the left-hand-side receives the allocation status and, if allocated, the bounds and value of the corresponding component of the expression. This occurs as if the following sequence of steps is carried out:

1. If the component of the variable is currently allocated, it is deallocated.
2. If the corresponding component of the expression is currently allocated, the component of the variable is allocated with the same bounds. The value of the component of the expression is then assigned to the corresponding component

of the variable using defined assignment if the declared type of the component has a defined assignment consistent with the component, and intrinsic assignment for the dynamic type of that component otherwise.

An allocated ultimate allocatable component of an actual argument that is associated with an **INTENT(OUT)** dummy argument is deallocated on procedure entry so that the corresponding component of the dummy argument has an allocation status of not currently allocated.

This ensures that any pointers that point to the previous contents of the allocatable component of the variable become undefined.

### Example

```
MODULE REAL_POLYNOMIAL_MODULE
  TYPE REAL_POLYNOMIAL
    REAL, ALLOCATABLE :: COEFF(:)
  END TYPE
  INTERFACE OPERATOR(+)
    MODULE PROCEDURE RP_ADD_RP, RP_ADD_R
  END INTERFACE
CONTAINS
  FUNCTION RP_ADD_R(P1,R)
    TYPE(REAL_POLYNOMIAL) RP_ADD_R, P1
    REAL R
    INTENT(IN) P1,R
    ALLOCATE(RP_ADD_R%COEFF(SIZE(P1%COEFF)))
    RP_ADD_R%COEFF = P1%COEFF
    RP_ADD_R%COEFF(1) = P1%COEFF(1) + R
  END FUNCTION
  FUNCTION RP_ADD_RP(P1,P2)
    TYPE(REAL_POLYNOMIAL) RP_ADD_RP, P1, P2
    INTENT(IN) P1, P2
    INTEGER M
    ALLOCATE(RP_ADD_RP%COEFF(MAX(SIZE(P1%COEFF), SIZE(P2%COEFF))))
    M = MIN(SIZE(P1%COEFF), SIZE(P2%COEFF))
    RP_ADD_RP%COEFF(:M) = P1%COEFF(:M) + P2%COEFF(:M)
    IF (SIZE(P1%COEFF)>M) THEN
      RP_ADD_RP%COEFF(M+1:) = P1%COEFF(M+1:)
    ELSE IF (SIZE(P2%COEFF)>M) THEN
      RP_ADD_RP%COEFF(M+1:) = P2%COEFF(M+1:)
    END IF
  END FUNCTION
END MODULE

PROGRAM EXAMPLE
  USE REAL_POLYNOMIAL_MODULE
  TYPE(REAL_POLYNOMIAL) P, Q, R
  P = REAL_POLYNOMIAL(/4,2,1/) ! Set P to (X**2+2X+4)
  Q = REAL_POLYNOMIAL(/1,1/) ! Set Q to (X+1)
  R = P + Q ! Polynomial addition
  PRINT *, 'Coefficients are: ', R%COEFF
END
```

End of Fortran 2003

## Procedure pointer component

Fortran 2003

Syntax of a procedure pointer component

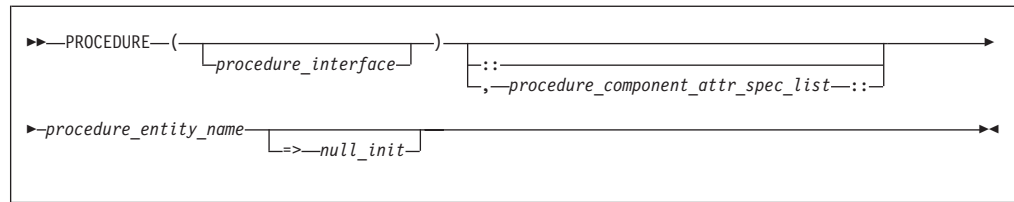

#### *procedure\_interface*

A declaration type specifier or the name of a procedure that has an explicit interface.

#### *procedure\_component\_attr\_spec\_list*

Attributes from the following list:

- **POINTER**
- **PASS**
- **NOPASS**
- *access\_spec*

#### *procedure\_entity\_name*

is the name of the procedure pointer that is being declared.

#### *null\_init*

is a reference to the NULL intrinsic function.

The **PASS** attribute defines the passed-object dummy argument of the type-bound procedure or procedure pointer component. When **NOPASS** is specified the procedure has no passed-object dummy argument.

**PASS** or **NOPASS** shall not both appear in the same *procedure\_component\_attr\_spec\_list*.

If the procedure pointer component has an implicit interface or has no arguments, **NOPASS** shall be specified.

If **PASS**(*arg-name*) appears, the interface shall have a dummy argument named *arg-name* which is the passed-object dummy argument.

The passed-object dummy argument must not be a pointer, must not be allocatable, and all its length type parameters must be assumed.

If neither **PASS** nor **NOPASS** is specified or **PASS** has no *arg-name*, the first dummy argument is the passed-object dummy argument.

**POINTER** must be present in each *procedure\_component\_attr\_spec\_list*.

End of Fortran 2003

## Component order

Component order is the sequence of non-parent components of a derived type as the sequence pertains to list-directed and namelist formatted input/output, and structure constructors that do not use component keywords.

If a type is not an extended type, its component order is the order of the declarations of the components in the derived type definition. The component order of an **F2003** extended type **F2003** consists of the component order of its

parent type, followed by any additional components in the order of their declarations in the extended derived type definition.

## Derived type Values

The set of values of a particular derived type consists of all possible sequences of the component values of its components. The following table lists component values of different types of components.

Table 12. Component values

Component	Component value
Pointer	Pointer association
Unallocated allocatable component <b>1</b>	Allocation status
Allocated allocatable component <b>1</b>	Allocation status, dynamic type and type parameters, bounds and value
Nonpointer nonallocatable	Value

### Notes:

1. Fortran 2003

## Type-bound procedures

### Fortran 2003

The procedure portion of a derived type definition allows you to bind specific procedures, generic interfaces, and final subroutines to a type.

### Syntax of a type-bound procedure

The syntax of the type-bound procedure portion of a derived type definition is as follows:

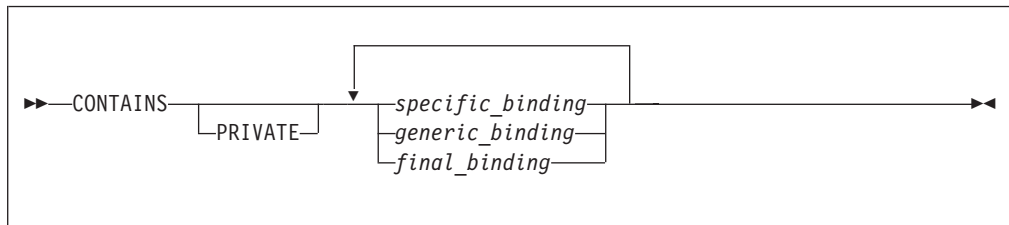

#### CONTAINS

For more information see “CONTAINS” on page 312

#### PRIVATE

You can only specify a **PRIVATE** statement if the type definition is within the specification part of a module.

#### specific\_binding

Binds a procedure to the type, or specifies a deferred binding in an abstract type. See “Specific binding” on page 59

#### generic\_binding

Defines a generic interface. See “Generic binding” on page 61

## final\_binding

Defines a list of final subroutines. See “Final binding” on page 62

You can identify a procedure using a binding name in the scope of the type definition, or an operator for a generic binding. The binding name is the name of a procedure of the type name and is referred to in the same way as a component of a type. For a specific binding, this name is the *binding\_name*. For a generic binding whose generic specification is *generic\_name*, this name is the *generic\_name*. A final binding, or a generic binding whose generic specification is not *generic\_name*, has no binding name.

## Specific binding

### Syntax of a *specific\_binding*

The form of specific binding is:

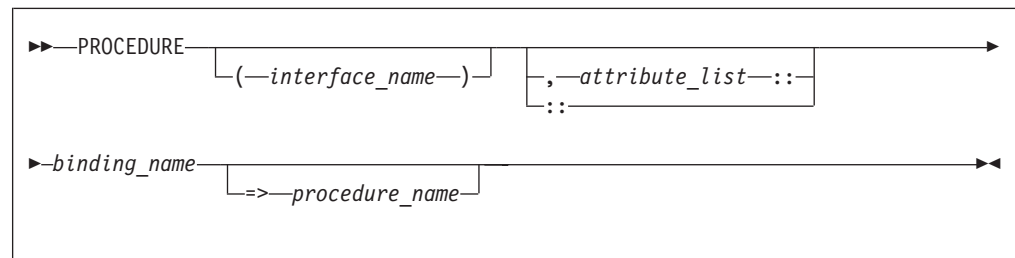

#### *interface\_name*

defines the interface for the procedure. The *interface\_name* must be the name of an abstract interface or of a procedure that has an explicit interface. If you specify an *interface\_name*, you must not specify a *procedure\_name*. An interface-name can appear if and only if the binding has the **DEFERRED** attribute

#### *attribute*

A binding can have one or more attributes, called binding attributes. The same binding attribute cannot appear more than once for the same binding. The list of binding attributes that you specify in an *attribute\_list* includes:

**PASS** Defines the passed-object dummy argument of the procedure.

#### **NOPASS**

Indicates that the procedure has no passed-object dummy argument. If the interface of the binding has no dummy argument of the type being defined, use **NOPASS**. **PASS** and **NOPASS** can not both be specified for the same binding.

#### *access\_spec*

Is **PUBLIC** or **PRIVATE**.

#### **NON\_OVERRIDABLE**

Prevents a binding from being overridden in an extended type. You must not specify **NON\_OVERRIDABLE** for a binding with the **DEFERRED** attribute.

#### **DEFERRED**

Marks the procedure as deferred. Deferred bindings must only be specified for derived type definitions with the **ABSTRACT**

attribute. A procedure with the **DEFERRED** binding attribute must specify an *interface\_name*. An overriding binding can have the **DEFERRED** attribute only if the binding it overrides is deferred. The **NON\_OVERRIDABLE** and **DEFERRED** binding attributes must not both be specified for the same procedure. See “Abstract types and deferred bindings” on page 52 and “Procedure overriding” on page 63 for more information.

*binding\_name*

is the name of a binding of a type.

*procedure\_name*

defines the interface for the procedure as well as the procedure to be executed when the procedure is referenced. The *procedure\_name* must be the name of an accessible module procedure or an external procedure that has an explicit interface. If neither `=>procedure_name` nor *interface\_name* appears, the *procedure\_name* is the same as the *binding\_name*. If `=>procedure_name` appears, you must specify the double-colon separator and an *interface\_name* must not be specified.

### Passed-object dummy arguments

A passed-object dummy argument applies to a type-bound procedure, or a procedure pointer component.

- If you specify **PASS** (*arg-name*) the interface of the procedure pointer component or named type-bound procedure has a dummy argument with the same name as *arg-name*. In this case, the passed-object dummy argument is the argument with the given name.
- If you do not specify **PASS** or **NOPASS**, or specify **PASS** without *arg-name*, the first dummy argument of a procedure pointer component or type-bound procedure is the passed-object dummy argument.

The passed-object dummy argument must be a scalar, nonpointer, nonallocatable dummy data object with the same declared type as the type being defined. The dummy argument must be polymorphic if and only if the type being defined is extensible.

In the example of a type-bound procedure with a specific binding, the type **POINT** contains a type-bound procedure with a specific binding. **LENGTH** is the type-bound procedure and **POINT\_LENGTH** is the name of a module procedure.

### Example of a type-bound procedure with a specific binding

```
TYPE :: POINT
  REAL :: X, Y
  CONTAINS
    PROCEDURE, PASS :: LENGTH => POINT_LENGTH
END TYPE POINT
...
```

The module-subprogram-part of the same module:

```
REAL FUNCTION POINT_LENGTH (A, B)

  CLASS (POINT), INTENT (IN) :: A, B
  POINT_LENGTH = SQRT ( (A%X - B%X)**2 + (A%Y - B%Y)**2 )

END FUNCTION POINT_LENGTH
```





```

    a%color_point = color_point(point=b, color=1)
    a%color_code = get_color_code(1)
END SUBROUTINE

```

## Final binding

### Syntax of a *final\_binding*

A derived type is finalizable if the derived type has any final subroutines or any nonpointer, nonallocatable component with a type that is finalizable. A nonpointer data entity is finalizable if the type of the entity is finalizable. The form of *final\_binding* is:

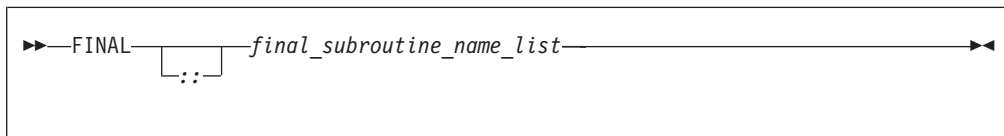

### FINAL

Specifies a list of final subroutines. A final subroutine can be executed when a data entity of that type is finalized.

#### *final\_subroutine\_name\_list*

A *final\_subroutine\_name* must be a module procedure with exactly one dummy argument. That argument must be nonoptional and must be a nonpointer, nonallocatable, nonpolymorphic variable of the derived type being defined. All length type parameters are assumed. The dummy argument cannot be **INTENT(OUT)**. A *final\_subroutine\_name* must not be one previously specified as a final subroutine for that type. A final subroutine must not have a dummy argument with the same kind type parameters and rank as the dummy argument of another final subroutine of that type.

The following is an example of extended types with final subroutines:

### Example of extended types with final subroutines

```

MODULE m
  TYPE :: t1
    REAL a,b
  END TYPE
  TYPE, EXTENDS(t1) :: t2
    REAL, POINTER :: c(:),d(:)
    CONTAINS
    FINAL :: t2f
  END TYPE
  TYPE, EXTENDS(t2) :: t3
    REAL, POINTER :: e
    CONTAINS
    FINAL :: t3f
  END TYPE

  CONTAINS
  SUBROUTINE t2f(x) ! Finalizer for TYPE(t2)'s extra components
    TYPE(t2) :: x

    print *, 'entering t2f'
    IF (ASSOCIATED(x%c)) then
      print *, ' c allocated, cleaning up'
      DEALLOCATE(x%c)
    end if
  end if

```

```

        IF (ASSOCIATED(x%d)) then
            print *, ' d allocated, cleaning up'
            DEALLOCATE(x%d)
        end if
    END SUBROUTINE
    SUBROUTINE t3f(y) ! Finalizer for TYPE(t3)'s extra components
        TYPE(t3) :: y

        print *, 'entering t3f'
        IF (ASSOCIATED(y%e)) then
            print *, ' e allocated, cleanup up'
            DEALLOCATE(y%e)
        end if
    END SUBROUTINE
END MODULE

program my_main
    call calc_span
end program

EXAMPLE: subroutine calc_span
    USE m
    TYPE(t1) x1
    TYPE(t2) x2
    TYPE(t3) x3

    allocate(x2%c(1:5), source=[1.0, 5.0, 10.0, 15.0, 20.0])
    allocate(x3%e, source=2.0)

    x2%c = x2%c + x3%e
    print *, 'calcs are=', x2%c

    ! Returning from this subroutine does
    ! nothing to x1. It is not finalizable
    ! the Fortran compiler places calls to the finalizer's at the
    ! end of a subroutine for the local variables of calc_span,
    ! as if the following calls were being made
    ! CALL t2f(x2)
    ! CALL t3f(x3)
    ! CALL t2f(x3%t2)
END SUBROUTINE

```

The output of the above program is:

```

calcs are= 3.000000000 7.000000000 12.000000000 17.000000000 22.000000000
entering t2f
 c allocated, cleaning up
entering t3f
 e allocated, cleanup up
entering t2f

```

## Procedure overriding

If a nongeneric binding you specify in a type definition has the same binding name as a binding inherited from the parent type, then the binding you specify in the type definition overrides the binding inherited from the parent type.

The overriding binding and the overridden binding must satisfy the following conditions:

- Both bindings have a passed-object dummy argument or neither does.
- If the overridden binding is pure, the overriding binding must also be pure.
- Both bindings are elemental or neither is.

- Both bindings must have the same number of dummy arguments.
- Passed-object dummy arguments, if any, must correspond by name and position.
- Dummy arguments that correspond by position must have the same names and characteristics, except for the type of the passed-object dummy arguments.
- Both bindings must be subroutines or functions having the same result characteristics.
- If the overridden binding is **PUBLIC** then the overriding binding cannot be **PRIVATE**.

### Example of procedure overriding

```

TYPE :: POINT
  REAL :: X, Y
  CONTAINS
  PROCEDURE, PASS :: LENGTH => POINT_LENGTH
END TYPE POINT
TYPE, EXTENDS (POINT) :: POINT_3D
  REAL :: Z
  CONTAINS
  PROCEDURE, PASS :: LENGTH => POINT_3D_LENGTH
END TYPE POINT_3D
...

```

The module-subprogram-part of the same module:

```

REAL FUNCTION POINT_LENGTH (A, B)
  CLASS (POINT), INTENT (IN) :: A, B
  POINT_LENGTH = SQRT ( (A%X - B%X)**2 + (A%Y - B%Y)**2 )
END FUNCTION POINT_LENGTH

REAL FUNCTION POINT_3D_LENGTH ( A, B )
  CLASS (POINT_3D), INTENT (IN) :: A
  CLASS (POINT), INTENT (IN) :: B
  SELECT TYPE(B)
    CLASS IS (POINT_3D)
      POINT_3D_LENGTH = SQRT( (A%X-B%X)**2 + (A%Y-B%Y)**2 + (A%Z-B%Z)**2 )
    RETURN
  END SELECT
  PRINT *, 'In POINT_3D_LENGTH, dynamic type of argument is incorrect.'
  STOP
END FUNCTION POINT_3D

```

If a generic binding specified in a type definition has the same *generic\_spec* that does not satisfy the conditions as an inherited binding, it extends the generic interface and must satisfy the requirements specified in “Unambiguous generic procedure references” on page 161.

If a generic binding in a type definition has the same *dtio\_generic\_spec* as one inherited from the parent, it extends the generic interface for the *dtio\_generic\_spec* and must satisfy the requirements specified in “Unambiguous generic procedure references” on page 161.

A binding of a type and a binding of an extension of that type are correspond if:

- The extension binding is the same as the type binding.
- The extension binding overrides a corresponding binding
- The extension binding is an inherited corresponding binding.

---

End of Fortran 2003

## The finalization process

Only finalizable entities are finalized. When an entity is finalized, the following steps are carried out in sequence:

1. If the dynamic type of the entity has a final subroutine whose dummy argument has the same kind type parameters and rank as the entity being finalized, it is called with the entity as an actual argument. Otherwise, if there is an elemental final subroutine whose dummy argument has the same kind type parameters as the entity being finalized, it is called with the entity as an actual argument. Otherwise, no subroutine is called at this point.
2. Each finalizable component that appears in the type definition is finalized. If the entity being finalized is an array, each finalizable component of each element of that entity is finalized separately.
3. If the entity is of extended type and the parent type is finalizable, the parent component is finalized.

If several entities are to be finalized as a result of one of the events that triggers finalization, these entities can be finalized in any order.

A final subroutine must not reference or define an object that has already been finalized. If the object is not finalized, it retains its definition status and is not undefined.

## When finalization occurs

Finalization occurs for the target of a pointer when the pointer is deallocated. If an object is allocated through pointer allocation and later becomes unreachable because all pointers to that object have had their pointer association status changed, finalization on the object does not occur.

Finalization of an allocatable entity occurs with the entity is deallocated.

Finalization for a nonpointer, nonallocatable object that is not a dummy argument or function result occurs immediately, before the object is undefined by the execution of a **RETURN** or **END** statement. If the object is defined in a module and no active procedures are still referencing the module, finalization does not take place.

Finalization of a structure constructor referenced by an executable construct occurs after execution of the innermost executable construct containing the reference.

Finalization for a function referenced by an executable construct takes place after execution of the innermost executable construct containing the reference.

Finalization for the result of a function referenced by a specification expression in a scoping unit takes place before the first statement in the scoping unit executes.

Finalization of a nonpointer, nonallocatable object that is an actual argument associated with an **INTENT(OUT)** dummy argument occurs when a procedure using the argument is invoked.

Finalization of a variable in an intrinsic assignment statement takes place after evaluation of the expression and before the definition of the variable.

### Non-finalized entities

If program execution is terminated, either by an error, such as an allocation failure, or by the execution of a **STOP** or **END PROGRAM** statement, entities existing immediately prior to termination are not finalized.

A nonpointer, nonallocatable object that has the **SAVE** attribute or that you specify in the main program is never finalized as a direct consequence of the execution of a **RETURN** or **END** statement

End of Fortran 2003

---

## Determining declared type for derived types

Two data objects have the same derived type if they are declared with reference to the same derived-type definition.

If the data objects are in different scoping units, they can still have the same derived type. Either the derived-type definition is accessible via host or use association, or the data objects reference their own derived-type definitions with the following conditions:

- They were both declared using standard derived type declarations, both have the same name, either both have the **SEQUENCE** property, or both have the **BIND** attribute, and both have components that do not have **PRIVATE** accessibility and agree in order, name and attributes; or
- They were declared using record structure declarations that were not unnamed, the types have the same name, have no **%FILL** components and have components that agree in order and attributes, and any **%FILL** components appear in the same positions in both.

A derived-type definition that has the **BIND** attribute or the **SEQUENCE** property is not the same as a definition declared to be private or that has components that are private.

### Example of determining type with derived types

```
PROGRAM MYPROG

  TYPE NAME                                ! Sequence derived type
    SEQUENCE
    CHARACTER(20) LASTNAME
    CHARACTER(10) FIRSTNAME
    CHARACTER(1)  INITIAL
  END TYPE NAME
  TYPE (NAME) PER1

  CALL MYSUB(PER1)
  PER1 = NAME('Smith','John','K')        ! Structure constructor
  CALL MYPRINT(PER1)

  CONTAINS
    SUBROUTINE MYSUB(STUDENT)              ! Internal subroutine MYSUB
      TYPE (NAME) STUDENT                  ! NAME is accessible via host association
    ..
  END SUBROUTINE MYSUB
END
```

```

SUBROUTINE MYPRINT(NAMES)      ! External subroutine MYPRINT
  TYPE NAME                    ! Same type as data type in MYPROG
    SEQUENCE
    CHARACTER(20) LASTNAME
    CHARACTER(10) FIRSTNAME
    CHARACTER(1)  INITIAL
  END TYPE NAME
  TYPE (NAME) NAMES           ! NAMES and PER1 from MYPROG
  PRINT *, NAMES              ! have the same data type
END SUBROUTINE

```

## An example with different component names

```

MODULE MOD
  STRUCTURE /S/
    INTEGER I
    INTEGER, POINTER :: P
  END STRUCTURE
  RECORD /S/ R
END MODULE
PROGRAM P
  USE MOD, ONLY: R
  STRUCTURE /S/
    INTEGER J
    INTEGER, POINTER :: Q
  END STRUCTURE
  RECORD /S/ R2
  R = R2 ! OK - same type name, components have same attributes and
         ! type (but different names)
END PROGRAM P

```

---

## Structure constructor

A structure constructor allows a scalar value of derived type to be constructed from a list of values. A structure constructor must not appear before the definition of the referenced derived type.

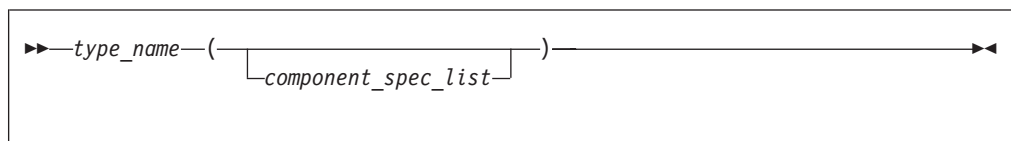

*type\_name*

is the name of the derived type, which must not be abstract.

*component\_spec* is:

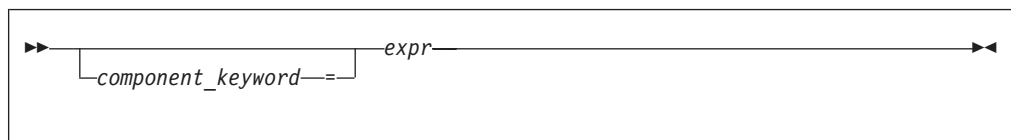

---

**Fortran 2003**

*component\_keyword*

is the name of a component of the type.

---

**End of Fortran 2003**

*expr* is an expression. Expressions are defined under Chapter 6, “Expressions and assignment,” on page 93.

The *type\_name* and all components of the type for which an *expr* appears must be accessible in the scoping unit containing the structure constructor.

In the absence of a component keyword, each *expr* is assigned to the corresponding component in component order. If a component keyword appears, the *expr* is assigned to the component named by the keyword. For a nonpointer component, the declared type and type parameters of the component and *expr* must conform in the same way as for a variable and expression in intrinsic assignment. If necessary, each value of intrinsic type is converted according to the rules of intrinsic assignment to a value that agrees in type and type parameters with the corresponding component of derived type. For a nonpointer nonallocatable component, the shape of the expression must conform with the shape of the component.

If a *component\_spec* is provided for a component, no *component\_spec* can be provided for any component with which it is inheritance-associated. At most one *component\_spec* can be provided for a component.

If a component with default initialization has no corresponding *expr*, then the default initialization is applied to that component.

The *component\_keyword* = specifier may be omitted from a *component\_spec* only if the *component\_keyword* = specifier has been omitted from each preceding *component\_spec* in the constructor.

A component that is a pointer can be declared with the same type that it is a component of. If a structure constructor is created for a derived type containing a pointer, the expression corresponding to the pointer component must evaluate to an object that would be an allowable target for such a pointer in a pointer assignment statement.

If a component of a derived type is allocatable, the corresponding constructor expression will either be a reference to the intrinsic function **NULL()** with no arguments, an allocatable entity, or will evaluate to an entity of the same rank. If the expression is a reference to the intrinsic function **NULL()**, the corresponding component of the constructor has a status of not currently allocated. If the expression is an allocatable entity, the corresponding component of the constructor has the same allocation status as that of allocatable entity and, if it is allocated, it has the same bounds (if any) and value. Otherwise, the corresponding component of the constructor has an allocation status of currently allocated, and has the same bounds (if any) and value as the expression.

---

**IBM Extension**

If a derived type is declared using the **record structure** declaration and has any **%FILL** component, the structure constructor for that type cannot be used.

If a derived type is accessible in a scoping unit and there is a local entity of class 1 that is not a derived type with the same name accessible in the scoping unit, the structure constructor for that type cannot be used in that scope.

---

**End of IBM Extension**



## Examples of Structure Constructors

### Example 1:

```
MODULE PEOPLE
  TYPE NAME
    SEQUENCE                               ! Sequence derived type
    CHARACTER(20) LASTNAME
    CHARACTER(10) FIRSTNAME
    CHARACTER(1) INITIAL
  END TYPE NAME

  TYPE PERSON                             ! Components accessible via use
                                          ! association

    INTEGER AGE
    INTEGER BIRTHDATE(3)                 ! Array component
    TYPE (NAME) FULLNAME                 ! Component of derived type
  END TYPE PERSON
END MODULE PEOPLE

PROGRAM TEST1
  USE PEOPLE
  TYPE (PERSON) SMITH, JONES
  SMITH = PERSON(30, (/6,30,63/), NAME('Smith','John','K'))
                                          ! Nested structure constructors

  JONES%AGE = SMITH%AGE                  ! Component designator
  CALL TEST2
CONTAINS

SUBROUTINE TEST2
  TYPE T
    INTEGER EMP_NO
    CHARACTER, POINTER :: EMP_NAME(:)    ! Pointer component
  END TYPE T
  TYPE (T) EMP_REC
  CHARACTER, TARGET :: NAME(10)
  EMP_REC = T(24744,NAME)                 ! Pointer assignment occurs
                                          ! for EMP_REC%EMP_NAME
END SUBROUTINE
END PROGRAM
```

---

### Fortran 95

---

### Example 2:

```
PROGRAM LOCAL_VAR
  TYPE DT
    INTEGER A
    INTEGER :: B = 80
  END TYPE

  TYPE(DT) DT_VAR                         ! DT_VAR%B IS INITIALIZED
END PROGRAM LOCAL_VAR
```

### Example 3:

```
MODULE MYMOD
  TYPE DT
    INTEGER :: A = 40
    INTEGER, POINTER :: B => NULL()
  END TYPE
END MODULE

PROGRAM DT_INIT
  USE MYMOD
  TYPE(DT), SAVE :: SAVED(8)             ! SAVED%A AND SAVED%B ARE INITIALIZED
  TYPE(DT) LOCAL(5)                      ! LOCAL%A LOCAL%B ARE INITIALIZED
END PROGRAM
```

End of Fortran 95

Fortran 2003

**Example 4:**

```
PROGRAM NEW_LOCAL
  TYPE DT
    INTEGER :: A = 20
    INTEGER :: B = 80
  END TYPE

  TYPE(DT):: DT_VAR = DT()
  TYPE(DT):: DT_VAR2 = DT(B=40)
  TYPE(DT):: DT_VAR3 = DT(B=10, A=50)

  PRINT *, 'DT_VAR =', DT_VAR
  PRINT *, 'DT_VAR2=', DT_VAR2
  PRINT *, 'DT_VAR3=', DT_VAR3
END PROGRAM NEW_LOCAL
```

```
! The expected output is :
DT_VAR = 20 80
DT_VAR2= 20 40
DT_VAR3= 50 10
```

End of Fortran 2003

---

## Chapter 5. Array concepts

XL Fortran provides a set of features, commonly referred to as array language, that allow you to manipulate arrays. This section provides background information on arrays and array language:

- “Arrays”
- “Array declarators” on page 73
- “Explicit-shape arrays” on page 73
- “Assumed-shape arrays” on page 75
- “Deferred-shape arrays” on page 76
- “Assumed-size arrays” on page 78
- “Array elements” on page 80
- “Array sections” on page 82
- “Array constructors” on page 88
- “Expressions involving arrays” on page 90

### Related information:

- Many statements in Chapter 11, “Statements and attributes,” on page 269, have special features and rules for arrays.
- This section makes frequent use of the **DIMENSION** attribute. See “DIMENSION” on page 322.
- A number of intrinsic functions are especially for arrays. These functions are mainly those classified as “Transformational intrinsic functions” on page 531.

---

## Arrays

An array is an ordered sequence of scalar data. All the elements of an array have the same type and type parameters.

A *whole array* is denoted by the name of the array:

```
! In this declaration, the array is given a type and dimension
REAL, DIMENSION(3) :: A
! In these expressions, each element is evaluated in each expression
PRINT *, A, A+5, COS(A)
```

A whole array is either a named constant or a variable.

### Bounds of a dimension

Each dimension in an array has an upper and lower bound, which determine the range of values that can be used as subscripts for that dimension. The bound of a dimension can be positive, negative, or zero.

---

#### IBM Extension

In XL Fortran, the bound of a dimension can be positive, negative or zero within the range  $-(2^{*31})$  to  $2^{*31}-1$  in 32-bit mode. The 64-bit mode range for bounds is  $-(2^{*63})$  to  $2^{*63}-1$ .

---

#### End of IBM Extension

If any lower bound is greater than the corresponding upper bound, the array is a zero-sized array, which has no elements but still has the properties of an array. The return values for the intrinsic inquiry functions **LBOUND** and **UBOUND** for such a dimension are one and zero, respectively.

When the bounds are specified in array declarators:

- The lower bound is a specification expression. If it is omitted, the default value is 1.
- The upper bound is a specification expression or asterisk (\*), and has no default value.

### Related information

- “Specification expressions” on page 96

## Extent of a dimension

The extent of a dimension is the number of elements in that dimension, computed as the value of the upper bound minus the value of the lower bound, plus one.

```
INTEGER, DIMENSION(5) :: X      ! Extent = 5
REAL :: Y(2:4,3:6)              ! Extent in 1st dimension = 3
                                ! Extent in 2nd dimension = 4
```

The minimum extent is zero, in a dimension where the lower bound is greater than the upper bound.

### IBM Extension

The theoretical maximum number of elements in an array is  $2^{31}-1$  elements in 32-bit mode, or  $2^{63}-1$  elements in XL Fortran 64-bit mode. Hardware addressing considerations make it impractical to declare any combination of data objects with a total size in bytes that exceeds this value.

### End of IBM Extension

Different array declarators associated by common, equivalence, or argument association can have different ranks and extents.

## Rank, shape, and size of an array

The rank of an array is the number of dimensions it has:

```
INTEGER, DIMENSION (10) :: A    ! Rank = 1
REAL, DIMENSION (-5:5,100) :: B ! Rank = 2
```

Standard Fortran allows an array to have up to seven dimensions.

### IBM Extension

An array can have up to twenty dimensions in XL Fortran.

### End of IBM Extension

A scalar is considered to have rank zero.

The shape of an array is derived from its rank and extents. It can be represented as a rank-one array where each element is the extent of the corresponding dimension:

```
INTEGER, DIMENSION (10,10) :: A      ! Shape = (/ 10, 10 /)
REAL, DIMENSION (-5:4,1:10,10:19) :: B ! Shape = (/ 10, 10, 10 /)
```

The size of an array is the number of elements in it, equal to the product of the extents of all dimensions:

```
INTEGER A(5)           ! Size = 5
REAL B(-1:0,1:3,4)    ! Size = 2 * 3 * 4 = 24
```

---

## Array declarators

An array declarator declares the shape of an array.

You must declare every named array, and no scoping unit can have more than one array declarator for the same name. An array declarator can appear in any of the *Compatible Statements and Attributes for Array Declarators* table.

Table 13. Compatible statements and attributes for array declarators

ALLOCATABLE	AUTOMATIC	COMMON
DIMENSION	PARAMETER	POINTER (integer)
POINTER	PROTECTED	STATIC
TARGET	Type Declaration	VOLATILE

For example:

```
DIMENSION :: A(1:5)           ! Declarator is "(1:5)"
REAL, DIMENSION(1,1:5) :: B ! Declarator is "(1,1:5)"
INTEGER C(10)                ! Declarator is "(10)"
```

The form of an array declarator is:

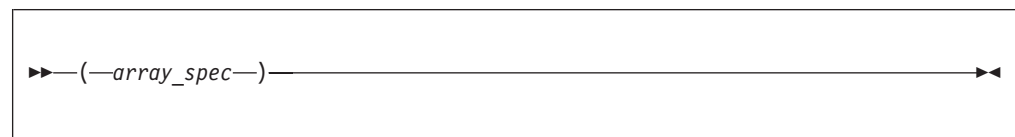

*array\_spec* is an array specification. It is a list of dimension declarators, each of which establishes the lower and upper bounds of an array, or specifies that one or both will be set at run time. Each dimension requires one dimension declarator.

An *array\_spec* is one of:  
*explicit\_shape\_spec\_list*  
*assumed\_shape\_spec\_list*  
*deferred\_shape\_spec\_list*  
*assumed\_size\_spec*

Each *array\_spec* declares a different kind of array, as explained in the following sections.

---

## Explicit-shape arrays

Explicit-shape arrays are arrays where the bounds are explicitly specified for each dimension.

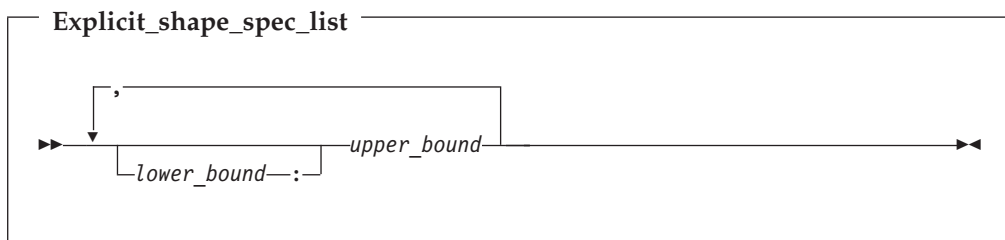

*lower\_bound*, *upper\_bound*  
are specification expressions

If any bound is not constant, the array must be declared inside a subprogram. The nonconstant bounds are determined on entry to the subprogram. If a lower bound is omitted, its default value is one.

The rank is the number of specified upper bounds. The shape of an explicit-shape dummy argument can differ from that of the corresponding actual argument.

The size is determined by the specified bounds.

The size of an explicit-shape dummy argument does not need to be the same as the size of the actual argument, but the size of the dummy argument cannot be larger than the size of the actual argument.

## Examples of explicit-shape arrays

```

INTEGER A,B,C(1:10,-5:5) ! All bounds are constant
A=8; B=3
CALL SUB1(A,B,C)
END
SUBROUTINE SUB1(X,Y,Z)
  INTEGER X,Y,Z(X,Y)      ! Some bounds are not constant
END SUBROUTINE

```

## Automatic arrays

An automatic array is an explicit-shape array you declare in a subprogram, that is not a dummy argument or pointer array, and has at least one bound that is a nonconstant specification expression. Evaluation of the bounds occurs on entry into the subprogram and remain unchanged during execution of the subprogram.

### Example of an automatic array

```

INTEGER X
COMMON X
X = 10
CALL SUB1(5)
END

SUBROUTINE SUB1(Y)
  INTEGER X
  COMMON X
  INTEGER Y
  REAL Z (X:20, 1:Y)      ! Automatic array. Here the bounds are made
                          ! available through dummy arguments and common
                          ! blocks, although Z itself is not a dummy
                          ! argument.
END SUBROUTINE

```

### Related information

- For general information about automatic data objects, see “Automatic objects” on page 18 and “Storage classes for variables” on page 26.

## Adjustable arrays

An adjustable array is an explicit-shape array dummy argument that has at least one non-constant bound.

### Example of an adjustable array

```
SUBROUTINE SUB1(X, Y)
INTEGER X, Y(X*3) ! Adjustable array. Here the bounds depend on a
                  ! dummy argument, and the array name is also passed in.
END SUBROUTINE
```

## Pointee arrays

### IBM Extension

Pointee arrays are explicit-shape or assumed-size arrays that can only appear in integer **POINTER** statements.

The declarator for a pointee array can only contain variables if you declare the array inside a subprogram, and any such variables must be:

- dummy arguments
- members of a common block
- use associated
- host associated

Evaluation of the bounds occurs on entry into the subprogram, and remain constant during execution of that subprogram.

Compiling with the **-qddim** option relaxes the restrictions on which variables can appear in an array declarator. Declarators in the main program can contain variable names, and any specified nonconstant bounds are re-evaluated each time you reference the array, so that you can change the properties of the pointee array by changing the values of the variables used in the bounds expressions.

### Example using **-qddim** to relax array declarator restrictions

```
@PROCESS DDIM
INTEGER PTE, N, ARRAY(10)
POINTER (P, PTE(N))
N = 5
P = LOC(ARRAY(2)) !
PRINT *, PTE      ! Print elements 2 through 6 of ARRAY
N = 7
PRINT *, PTE      ! Increase the size
                  ! Print elements 2 through 8 of ARRAY
END
```

### End of IBM Extension

## Assumed-shape arrays

Assumed-shape arrays are dummy argument arrays where the extent of each dimension is taken from the associated actual arguments.

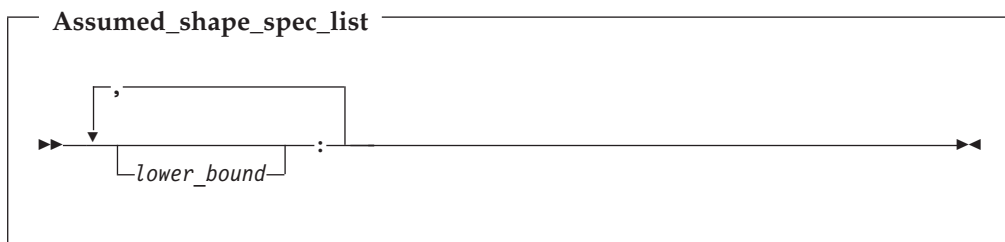

*lower\_bound*  
is a specification expression

Each lower bound defaults to one, or may be explicitly specified. Each upper bound is set on entry to the subprogram to the specified lower bound (not the lower bound of the actual argument array) plus the extent of the dimension minus one.

The extent of any dimension is the extent of the corresponding dimension of the associated actual argument.

The rank is the number of colons in the *assumed\_shape\_spec\_list*.

The shape is assumed from the associated actual argument array.

The size is determined on entry to the subprogram where it is declared, and equals the size of the associated argument array.

**Note:** Subprograms that have assumed-shape arrays as dummy arguments must have explicit interfaces.

## Examples of assumed-shape arrays

```

INTERFACE
  SUBROUTINE SUB1(B)
    INTEGER B(1:,:,10:)
  END SUBROUTINE
END INTERFACE
INTEGER A(10,11:20,30)
CALL SUB1 (A)
END
SUBROUTINE SUB1(B)
  INTEGER B(1:,:,10:)
  ! Inside the subroutine, B is associated with A.
  ! It has the same extents as A but different bounds (1:10,1:10,10:39).
END SUBROUTINE

```

---

## Deferred-shape arrays

Deferred-shape arrays are allocatable arrays or array pointers, where the bounds can be defined or redefined during execution of the program.



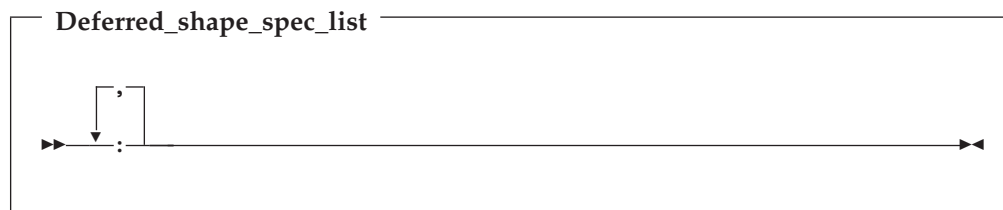

The extent of each dimension (and the related properties of bounds, shape, and size) is undefined until the array is allocated or the pointer is associated with an array that is defined. Before then, no part of the array may be defined, or referenced except as an argument to an appropriate inquiry function. At that point, an array pointer assumes the properties of the target array, and the properties of an allocatable array are specified in an **ALLOCATE** statement.

The rank is the number of colons in the *deferred\_shape\_spec\_list*.

Although a *deferred\_shape\_spec\_list* can appear identical to an *assumed\_shape\_spec\_list*, deferred-shape arrays and assumed-shape arrays are not the same. A deferred-shape array must have the **ALLOCATABLE** or **POINTER** attribute, while an assumed-shape array must be a dummy argument that does not have the **ALLOCATABLE** or **POINTER** attribute. The bounds of a deferred-shape array, and the actual storage associated with it, can be changed at any time by reallocating the array or by associating the pointer with a different array, while these properties remain the same for an assumed-shape array during the execution of the containing subprogram.

**Related information:**

- “Allocation status” on page 26
- “Data pointer assignment” on page 123
- “Pointer association” on page 152
- “ALLOCATABLE” on page 274
- “ALLOCATED(X)” on page 541
- “ASSOCIATED(POINTER, TARGET)” on page 545

## Allocatable arrays

A deferred-shape array that has the **ALLOCATABLE** attribute is referred to as an allocatable array. Determination of the bounds and shape of the array occurs when you allocate storage using an **ALLOCATE** statement.

**Example of an allocatable array**

```
INTEGER, ALLOCATABLE, DIMENSION(:,:,:) :: A
ALLOCATE(A(10,-4:5,20)) ! Bounds of A are now defined (1:10,-4:5,1:20)
DEALLOCATE(A)
ALLOCATE(A(5,5,5))      ! Change the bounds of A
```

**Migration Tip:**

If you do not know the size of an array at compile time, you can avoid unnecessary memory usage by making the array allocatable instead of declaring it with a maximum size.

FORTRAN 77 source

```

      INTEGER A(1000),B(1000),C(1000)
C 1000 is the maximum size
      WRITE (6,*) "Enter the size of the arrays:"
      READ (5,*) N

      :
      DO I=1,N
        A(I)=B(I)+C(I)
      END DO
      END

```

Source for Fortran 90 or above:

```

INTEGER, ALLOCATABLE, DIMENSION(:) :: A,B,C
WRITE (6,*) "Enter the size of the arrays:"
READ (5,*) N
ALLOCATE (A(N),B(N),C(N))

      :
A=B+C
      END

```

## Array pointers

An array with the **POINTER** attribute is referred to as an array pointer. Its bounds and shape are determined when it is associated with a target through pointer assignment or execution of an **ALLOCATE** statement.

```

REAL, POINTER, DIMENSION(:,:) :: B
REAL, TARGET, DIMENSION(5,10) :: C, D(10,10)
B => C           ! Bounds of B are now defined (1:5,1:10)
B => D           ! B now has different bounds and is associated
                  ! with different storage
ALLOCATE(B(5,5)) ! Change bounds and storage association again
END

```

**Related information:**

- "Pointer association" on page 152

---

## Assumed-size arrays

Assumed-size arrays are dummy argument arrays where the size is inherited from the associated actual array, but the rank and extents may differ.

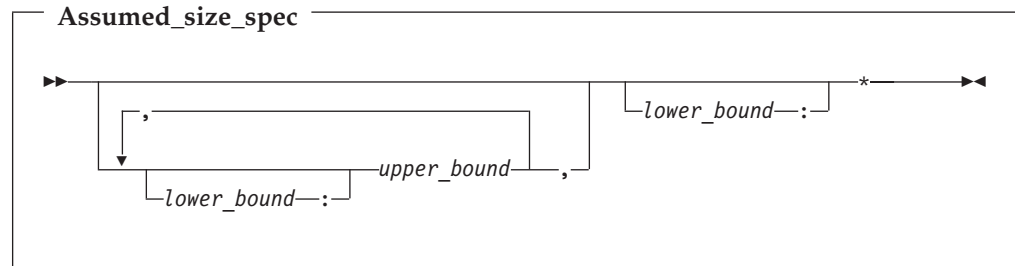

*lower\_bound, upper\_bound*  
are specification expressions

If any bound is not constant, the array must be declared inside a subprogram and the nonconstant bounds are determined on entry to the subprogram. If a lower bound is omitted, its default value is 1.

The last dimension has no upper bound and is designated instead by an asterisk. You must ensure that references to elements do not go past the end of the actual array.

The rank equals one plus the number of *upper\_bound* specifications in its declaration, which may be different from the rank of the actual array it is associated with.

The size is assumed from the actual argument that is associated with the assumed-size array:

- If the actual argument is a noncharacter array, the size of the assumed-size array is that of the actual array.
- If the actual argument is an array element from a noncharacter array, and if the size remaining in the array beginning at this element is *S*, then the size of the dummy argument array is *S*. Array elements are processed in array element order.
- If the actual argument is a character array, array element, or array element substring, and assuming that:
  - *A* is the starting offset, in characters, into the character array
  - *T* is the total length, in characters, of the original array
  - *S* is the length, in characters, of an element in the dummy argument array

then the size of the dummy argument array is:

**MAX( INT ( T - A + 1 ) / S, 0 )**

For example:

```

CHARACTER(10) A(10)
CHARACTER(1) B(30)
CALL SUB1(A)           ! Size of dummy argument array is 10
CALL SUB1(A(4))        ! Size of dummy argument array is 7
CALL SUB1(A(6)(5:10)) ! Size of dummy argument array is 4 because there
                       ! are just under 4 elements remaining in A
CALL SUB1(B(12))       ! Size of dummy argument array is 1, because the
                       ! remainder of B can hold just one CHARACTER(10)
                       ! element.
END
SUBROUTINE SUB1(ARRAY)
  CHARACTER(10) ARRAY(*)
  ...
END SUBROUTINE

```

## Examples of assumed-size arrays

```
INTEGER X(3,2)
DO I = 1,3
  DO J = 1,2
    X(I,J) = I * J      ! The elements of X are 1, 2, 3, 2, 4, 6
  END DO
END DO
PRINT *,SHAPE(X)       ! The shape is (/ 3, 2 /)
PRINT *,X(1,:)        ! The first row is (/ 1, 2 /)
CALL SUB1(X)
CALL SUB2(X)
END
SUBROUTINE SUB1(Y)
  INTEGER Y(2,*)       ! The dimensions of y are the reverse of x above
  PRINT *, SIZE(Y,1)   ! We can examine the size of the first dimension
                        ! but not the last one.
  PRINT *, Y(:,1)     ! We can print out vectors from the first
  PRINT *, Y(:,2)     ! dimension, but not the last one.
END SUBROUTINE
SUBROUTINE SUB2(Y)
  INTEGER Y(*)         ! Y has a different rank than X above.
  PRINT *, Y(6)       ! We have to know (or compute) the position of
                        ! the last element. Nothing prevents us from
                        ! subscripting beyond the end.
END SUBROUTINE
```

### Notes:

1. An assumed-size array cannot be used as a whole array in an executable construct unless it is an actual argument in a subprogram reference that does not require the shape:

```
! A is an assumed-size array.
```

```
PRINT *,
UBOUND(A,1) ! OK - only examines upper bound of first dimension.
PRINT *, LBOUND(A) ! OK - only examines lower bound of each dimension.
! However, 'B=UBOUND(A)' or 'A=5' would reference the upper bound of
! the last dimension and are not allowed. SIZE(A) and SHAPE(A) are
! also not allowed.
```

2. If a section of an assumed-size array has a subscript triplet as its last section subscript, the upper bound must be specified. (Array sections and subscript triplets are explained in a subsequent section.)

```
! A is a 2-dimensional assumed-size array
PRINT *, A(:, 6)      ! Triplet with no upper bound is not last dimension.
PRINT *, A(1, 1:10)  ! Triplet in last dimension has upper bound of 10.
PRINT *, A(5, 5:9:2) ! Triplet in last dimension has upper bound of 9.
```

---

## Array elements

Array elements are the scalar data that make up an array. Each element inherits the type, type parameters, and **INTENT**, **PARAMETER**, F2003 **PROTECTED**, F2003 **TARGET**, F2003 **ASYNCHRONOUS**, F2003 and F2003 **VOLATILE** F2003 attributes from its parent array. The **POINTER** and **ALLOCATABLE** attributes are not inherited.

You identify an array element by an *array element designator*, whose form is:



## Array sections

An array section is a selected portion of an array. It is an array subobject that designates a set of elements from an array, or a specified substring or derived-type component from each of those elements. An array section is also an array.

**Note:** This introductory section describes the simple case, where structure components are not involved. “Array sections and structure components” on page 86 explains the additional rules for specifying array sections that are also structure components.

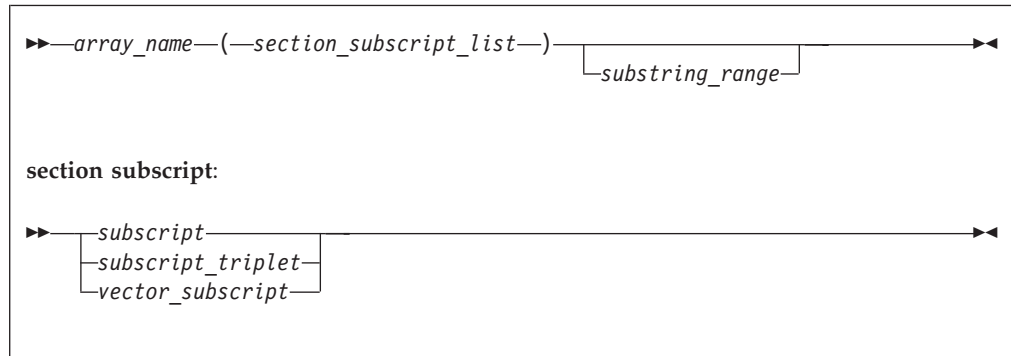

*section\_subscript*

designates some set of elements along a particular dimension. It can be composed of a combination of the following:

*subscript*

is a scalar integer expression, explained in “Array elements” on page 80.

IBM Extension

A subscript can be a scalar real expression in XL Fortran.

End of IBM Extension

*subscript\_triplet, vector subscript*

designate a (possibly empty) sequence of subscripts in a given dimension. For details, see “Subscript triplets” on page 83 and “Vector subscripts” on page 85.

**Note:** At least one of the dimensions must be a subscript triplet or vector subscript, so that an array section is distinct from an array element:

```

INTEGER, DIMENSION(5,5,5) :: A
A(1,2,3) = 100
A(1,3,3) = 101
PRINT *, A(1,2,3)      ! A single array element, 100.
PRINT *, A(1,2:2,3)   ! A one-element array section, (/ 100 /)
PRINT *, A(1,2:3,3)   ! A two-element array section,
                      ! (/ 100, 101 /)
  
```

*substring\_range*

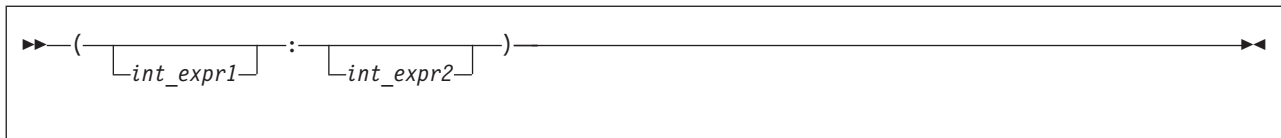

*int\_expr1* and *int\_expr2* are scalar integer expressions called substring expressions, defined in “Character substrings” on page 43. They specify the leftmost and rightmost character positions, respectively, of a substring of each element in the array section. If an optional *substring\_range* is present, the section must be from an array of character objects.

An array section is formed from the array elements specified by the sequences of values from the individual subscripts, subscript triplets, and vector subscripts, arranged in column-major order.

For example, if SECTION = A( 1:3, (/ 5,6,5 /), 4 ):

- The sequence of numbers for the first dimension is 1, 2, 3.
- The sequence of numbers for the second dimension is 5, 6, 5.
- The subscript for the third dimension is the constant 4.

The section is made up of the following elements of A, in this order:

A(1,5,4)				SECTION(1,1)
A(2,5,4)		----- First column -----		SECTION(2,1)
A(3,5,4)				SECTION(3,1)
A(1,6,4)				SECTION(1,2)
A(2,6,4)		----- Second column -----		SECTION(2,2)
A(3,6,4)				SECTION(3,2)
A(1,5,4)				SECTION(1,3)
A(2,5,4)		----- Third column -----		SECTION(2,3)
A(3,5,4)				SECTION(3,3)

Some examples of array sections include:

```

INTEGER, DIMENSION(20,20) :: A
! These references to array sections require loops or multiple
! statements in FORTRAN 77.
PRINT *, A(1:5,1)                ! Contiguous sequence of elements
PRINT *, A(1:20:2,10)            ! Noncontiguous sequence of elements
PRINT *, A(:,5)                  ! An entire column
PRINT *, A( (/1,10,5/), (/7,3,1/) ) ! A 3x3 assortment of elements

```

**Related information:**

“Structure components” on page 53.

## Subscript triplets

A subscript triplet consists of two subscripts and a stride, and defines a sequence of numbers corresponding to array element positions along a single dimension.

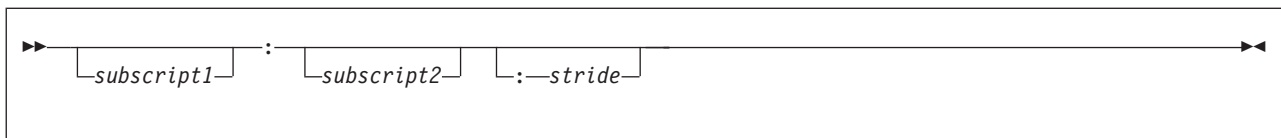

*subscript1*, *subscript2*  
are subscripts that designate the first and last values in the sequence of indices for a dimension.

If the first subscript is omitted, the lower array bound of that dimension is used. If the second subscript is omitted, the upper array bound of that dimension is used. (The second subscript is mandatory for the last dimension when specifying sections of an assumed-size array.)

*stride* is a scalar integer expression that specifies how many subscript positions to count to reach the next selected element.

 A stride can be a scalar real expression in XL Fortran.

If the stride is omitted, it has a value of 1. The stride must have a nonzero value:

- A positive stride specifies a sequence of integers that begins with the first subscript and proceeds in increments of the stride to the largest integer that is not greater than the second subscript. If the first subscript is greater than the second, the sequence is empty.
- When the stride is negative, the sequence begins at the first subscript and continues in increments specified by the stride to the smallest integer equal to or greater than the second subscript. If the second subscript is greater than the first, the sequence is empty.

Calculations of values in the sequence use the same steps as shown in “Executing a DO statement” on page 132.

A subscript in a subscript triplet does not have to be within the declared bounds for that dimension if all the values used in selecting the array elements for the array section are within the declared bounds:

```
INTEGER A(9)
PRINT *, A(1:9:2) ! Count from 1 to 9 by 2s: 1, 3, 5, 7, 9.
PRINT *, A(1:10:2) ! Count from 1 to 10 by 2s: 1, 3, 5, 7, 9.
                  ! No element past A(9) is specified.
```

## Examples of subscript triplets

```
REAL, DIMENSION(10) :: A
INTEGER, DIMENSION(10,10) :: B
CHARACTER(10) STRING(1:100)

PRINT *, A(:)           ! Print all elements of array.
PRINT *, A(::5)        ! Print elements 1 through 5.
PRINT *, A(3:)         ! Print elements 3 through 10.

PRINT *, STRING(50:100) ! Print all characters in
                        ! elements 50 through 100.

! The following statement is equivalent to A(2:10:2) = A(1:9:2)
A(2::2) = A(::9:2)      ! LHS = A(2), A(4), A(6), A(8), A(10)
                        ! RHS = A(1), A(3), A(5), A(7), A(9)
                        ! The statement assigns the odd-numbered
                        ! elements to the even-numbered elements.

! The following statement is equivalent to PRINT *, B(1:4:3,1:7:6)
PRINT *, B(::4:3,::7:6) ! Print B(1,1), B(4,1), B(1,7), B(4,7)

PRINT *, A(10:1:-1)    ! Print elements in reverse order.
```





```

PRINT *, A(10:1:1)           ! These two are
PRINT *, A(1:10:-1)        ! both zero-sized.
END

```

## Vector subscripts

A vector subscript is an integer array expression of rank one, designating a sequence of subscripts that correspond to the values of the elements of the expression.

 A vector subscript can be a real array expression of rank one in XL Fortran. 

The sequence does not have to be in order, and may contain duplicate values:

```

INTEGER A(10), B(3), C(3)
PRINT *, A( (/ 10,9,8 /) ) ! Last 3 elements in reverse order
B = A( (/ 1,2,2 /) )       ! B(1) = A(1), B(2) = A(2), B(3) = A(2) also
END

```

An array section with a vector subscript in which two or more elements of the vector subscript have the same value is called a many-one section. Such a section must not:

- Appear on the left side of the equal sign in an assignment statement
- Be initialized through a **DATA** statement
- Be used as an input item in a **READ** statement

### Notes:

1. An array section used as an internal file must not have a vector subscript.
2. If you pass an array section with a vector subscript as an actual argument, the associated dummy argument must not be defined or redefined.
3. An array section with a vector subscript must not be the target in a pointer assignment statement.

```

! We can use the whole array VECTOR as a vector subscript for A and B
INTEGER, DIMENSION(3) :: VECTOR= (/ 1,3,2 /), A, B
INTEGER, DIMENSION(4) :: C = (/ 1,2,4,8 /)
A(VECTOR) = B           ! A(1) = B(1), A(3) = B(2), A(2) = B(3)
A = B( (/ 3,2,1 /) )   ! A(1) = B(3), A(2) = B(2), A(3) = B(1)
PRINT *, C(VECTOR(1:2)) ! Prints C(1), C(3)
END

```

## Array sections and substring ranges

For an array section with a substring range, each element in the result is the designated character substring of the corresponding element of the array section. The rightmost array name or component name must be of type character.

```

PROGRAM SUBSTRING
TYPE DERIVED
  CHARACTER(10) STRING(5) ! Each structure has 5 strings of 10 chars.
END TYPE DERIVED
TYPE (DERIVED) VAR, ARRAY(3,3) ! A variable and an array of derived type.

VAR%STRING(:)(1:3) = 'abc' ! Assign to chars 1-3 of elements 1-5.
VAR%STRING(3:)(4:6) = '123' ! Assign to chars 4-6 of elements 3-5.

ARRAY(1:3,2)%STRING(3)(5:10) = 'hello'
! Assign to chars 5-10 of the third element in
! ARRAY(1,2)%STRING, ARRAY(2,2)%STRING, and
! ARRAY(3,2)%STRING
END

```

## Array sections and structure components

Understanding how array sections and structure components interact requires a familiarity with the syntax for “Structure components” on page 53.

What we defined at the beginning of this section as an array section is really only a subset of the possible array sections. An array name or array name with a *section\_subscript\_list* can be a subobject of a structure component:

*struct\_sect\_subobj:*

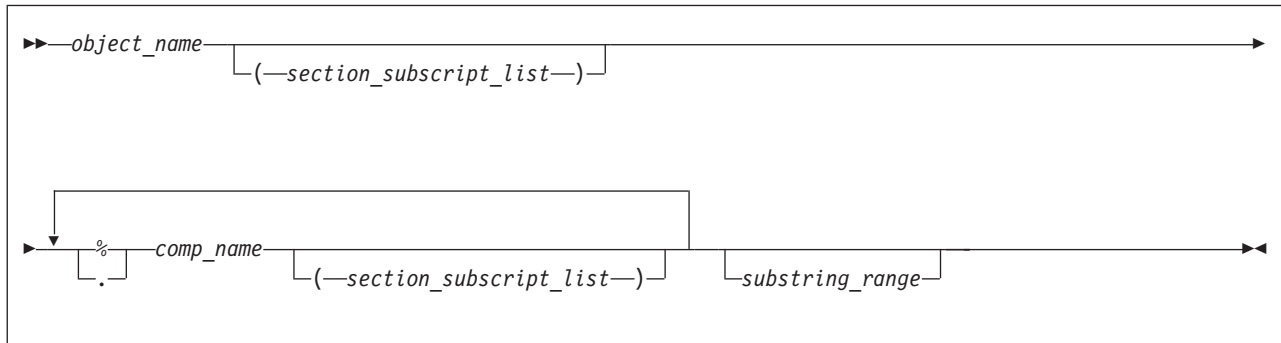

*object\_name*

is the name of an object of derived type

*section\_subscript\_list, substring\_range*

are the same as defined under “Array sections” on page 82

*comp\_name*

is the name of a derived-type component

% or . Separator character.

**Note:** The . (period) separator is an IBM extension.

**Notes:**

1. The type of the last component determines the type of the array.
2. Only one part of the structure component may have nonzero rank. Either the rightmost *comp\_name* must have a *section\_subscript\_list* with nonzero rank, or another part must have nonzero rank.
3. Any parts to the right of the part with nonzero rank must not have the **ALLOCATABLE** or **POINTER** attributes.

```

TYPE BUILDING_T
  LOGICAL RESIDENTIAL
END TYPE BUILDING_T

TYPE STREET_T
  TYPE (BUILDING_T) ADDRESS(500)
END TYPE STREET_T

TYPE CITY_T
  TYPE (STREET_T) STREET(100,100)
END TYPE CITY_T

TYPE (CITY_T) PARIS
TYPE (STREET_T) S
TYPE (BUILDING_T) RESTAURANT
! LHS is not an array section, no subscript triplets or vector subscripts.
PARIS%STREET(10,20) = S
! None of the parts are array sections, but the entire construct
!   is a section because STREET has a nonzero rank and is not
!   the rightmost part.
PARIS%STREET%ADDRESS(100) = BUILDING_T(.TRUE.)

! STREET(50:100,10) is an array section, making the LHS an array section
!   with rank=1, shape=(/51/).
! ADDRESS(123) must not be an array section because only one can appear
!   in a reference to a structure component.
PARIS%STREET(50:100,10)%ADDRESS(123)%RESIDENTIAL = .TRUE.
END

```

## Rank and shape of array sections

For an array section that is not a subobject of a structure component, the rank is the number of subscript triplets and vector subscripts in the *section\_subscript\_list*. The number of elements in the shape array is the same as the number of subscript triplets and vector subscripts, and each element in the shape array is the number of integer values in the sequence designated by the corresponding subscript triplet or vector subscript.

For an array section that is a subobject of a structure component, the rank and shape are the same as those of the part of the component that is an array name or array section.

```

DIMENSION :: ARR1(10,20,100)
TYPE STRUCT2_T
  LOGICAL SCALAR_COMPONENT
END TYPE
TYPE STRUCT_T
  TYPE (STRUCT2_T), DIMENSION(10,20,100) :: SECTION
END TYPE

TYPE (STRUCT_T) STRUCT

! One triplet + one vector subscript, rank = 2.
! Triplet designates an extent of 10, vector subscript designates
! an extent of 3, thus shape = (/ 10,3 /).
ARR1(:, (/ 1,3,4 /), 10) = 0

! One triplet, rank = 1.
! Triplet designates 5 values, thus shape = (/ 5 /).
STRUCT%SECTION(1,10,1:5)%SCALAR_COMPONENT = .TRUE.

! Here SECTION is the part of the component that is an array,
! so rank = 3 and shape = (/ 10,20,100 /), the same as SECTION.
STRUCT%SECTION%SCALAR_COMPONENT = .TRUE.

```

---

## Array constructors

An array constructor is a sequence of specified scalar values. It constructs a rank-one array whose element values are those specified in the sequence. You can construct arrays of rank greater than one using an intrinsic function. See “RESHAPE(SOURCE, SHAPE, PAD, ORDER)” on page 640 for details.

### Syntax of an array constructor

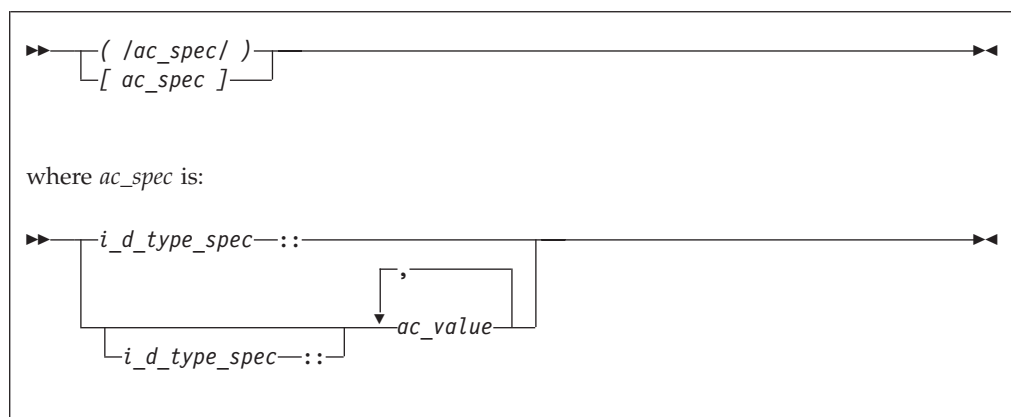

*i\_d\_type\_spec*

Is an *intrinsic\_type\_spec* or *derived\_type\_spec*. See “Type Declaration” on page 461 for a list of possible type specifications.

**BYTE** is not allowed as an *intrinsic\_type\_spec* in an array constructor.

If you specify an intrinsic type, each *ac\_value* expression in the array constructor must be of an intrinsic type compatible with the type you specify.

*ac\_value*

is an expression or implied-**DO** list that provides values for array elements. If *type\_spec* is omitted, each *ac\_value* in the array constructor must have the same type and type parameters.

## Rules for array constructors

If *i\_d\_type\_spec* is omitted, each *ac\_value* expression in the array constructor must have the same type and kind type parameters.

A *i\_d\_type\_spec* specifies the type and type parameters of the array constructor. Each *ac\_value* expression must be compatible with intrinsic assignment to a variable with these type and type parameters. Each value is converted to the type parameters of the array constructor.

If *i\_d\_type\_spec* appears without an *ac\_value*, a zero-sized rank-one array is created.

If *ac\_value* is:

- A scalar expression, its value specifies an element of the array constructor.
- An array expression, the values of the elements of the expression, in array element order, specify the corresponding sequence of elements of the array constructor.
- An implied-**DO** list, it is expanded to form an *ac\_value* sequence under the control of the *implied\_do\_variable*, as in the **DO** construct.

The character length of an *ac\_value* in an implied-**DO** with an iteration count of zero must not depend on the value of the *implied\_do\_variable* and must not depend on the value of an expression that is not an initialization expression.

### Example of an array constructor

```
INTEGER, DIMENSION(5) :: A, B, C, D(2,2)
CHARACTER(5), DIMENSION(3)::COLOR
A = (/ 1,2,3,4,5 /)           ! Assign values to all elements in A
A(3:5) = (/ 0,1,0 /)         ! Assign values to some elements
C = MERGE (A, B, (/ T,F,T,T,F /)) ! Construct temporary logical mask

! The array constructor produces a rank-one array, which
! is turned into a 2x2 array that can be assigned to D.
D = RESHAPE( SOURCE = (/ 1,2,1,2 /), SHAPE = (/ 2,2 /) )

! Here, the constructor linearizes the elements of D in
! array-element order into a one-dimensional result.
PRINT *, A( (/ D /) )
! without a type_spec, each character literal must be of length 5
COLOR= ['RED ', 'GREEN', 'BLUE ']
! with a type_spec, padding and truncation of each character literal occurs
COLOR= [CHARACTER(5)::'RED', 'GREEN', 'BLUE']
```

## Implied-DO list for an array constructor

Implied-DO loops in array constructors help to create a regular or cyclic sequence of values, to avoid specifying each element individually.

A zero-sized array of rank one is formed if the sequence of values generated by the loop is empty.

```
▶—(—ac_value_list—,—implied_do_variable— = —expr1—,—expr2—expr3)—▶
```

*implied\_do\_variable*

is a named scalar integer IBM or real IBM variable.

In a nonexecutable statement, the type must be integer. You must not reference the value of an *implied\_do\_variable* in the limit expressions *expr1* or *expr2*. Loop processing follows the same rules as for an implied-DO in "DATA" on page 314, and uses integer or real arithmetic depending on the type of the implied-DO variable.

The variable has the scope of the implied-DO, and it must not have the same name as another implied-DO variable in a containing array constructor implied-DO:

```
M = 0
PRINT *, (/ (M, M=1, 10) /) ! Array constructor implied-DO
PRINT *, M                ! M still 0 afterwards
PRINT *, (M, M=1, 10)     ! Non-array-constructor implied-DO
PRINT *, M                ! This one goes to 11
PRINT *, (/ ((M, M=1, 5), N=1, 3) /)
! The result is a 15-element, one-dimensional array.
! The inner loop cannot use N as its variable.
```

*expr1*, *expr2*, and *expr3*

are scalar integer IBM or real IBM expressions

```
PRINT *, (/ (I, I = 1, 3) /)
! Sequence is (1, 2, 3)
PRINT *, (/ (I, I = 1, 10, 2) /)
! Sequence is (1, 3, 5, 7, 9)
PRINT *, (/ (I, I+1, I+2, I = 1, 3) /)
! Sequence is (1, 2, 3, 2, 3, 4, 3, 4, 5)

PRINT *, (/ ( (I, I = 1, 3), J = 1, 3 ) /)
! Sequence is (1, 2, 3, 1, 2, 3, 1, 2, 3)

PRINT *, (/ ( (I, I = 1, J), J = 1, 3 ) /)
! Sequence is (1, 1, 2, 1, 2, 3)

PRINT *, (/2,3,(I, I+1, I = 5, 8)/)
! Sequence is (2, 3, 5, 6, 6, 7, 7, 8, 8, 9).
! The values in the implied-DO loop before
! I=5 are calculated for each iteration of the loop.
```

---

## Expressions involving arrays

Arrays can be used in the same kinds of expressions and operations as scalars. Intrinsic operations, assignments, or elemental procedures can be applied to one or more arrays.

For intrinsic operations, in expressions involving two or more array operands, the arrays must have the same shape so that the corresponding elements of each array can be assigned to or be evaluated. In a defined operation arrays can have different shapes. Arrays with the same shape are *conformable*. In a context where a conformable entity is expected, you can also use a scalar value: it is conformable with any array, such that it is treated like an array where each array element has the value of the scalar.

For example:

```
INTEGER, DIMENSION(5,5) :: A,B,C
REAL, DIMENSION(10) :: X,Y
! Here are some operations on arrays
A = B + C      ! Add corresponding elements of both arrays.
A = -B         ! Assign the negative of each element of B.
A = MAX(A,B,C) ! A(i,j) = MAX( A(i,j), B(i,j), C(i,j) )
X = SIN(Y)     ! Calculate the sine of each element.
! These operations show how scalars are conformable with arrays
A = A + 5      ! Add 5 to each element.
A = 10         ! Assign 10 to each element.
A = MAX(B, C, 5) ! A(i,j) = MAX( B(i,j), C(i,j), 5 )

END
```

**Related information:**

“Elemental intrinsic procedures” on page 529

“Intrinsic assignment” on page 110

“WHERE” on page 478 shows a way to assign values to some elements in an array but not to others

“FORALL construct” on page 120





---

## Chapter 6. Expressions and assignment

This section describes the rules for formation, interpretation, and evaluation of expressions and assignment statements:

- “Introduction to expressions and assignment”
- “Constant expressions” on page 94
- “Specification expressions” on page 96
- “Operators and expressions” on page 98
- “Extended intrinsic and defined operations” on page 106
- “How expressions are evaluated” on page 107
- “Intrinsic assignment” on page 110
- “WHERE construct” on page 113
- F95 “FORALL construct” on page 120 F95
- “Data pointer assignment” on page 123

### Related information

- “Defined operators” on page 163
- “Defined assignment” on page 165

---

### Introduction to expressions and assignment

An expression is a data reference or a computation, and is formed from operands, operators, and parentheses. An expression, when evaluated, produces a value, which has a declared type, a dynamic type, a shape, and possibly type parameters.

An *operand* is either a scalar or an array. An *operator* is either intrinsic or defined. A unary operation has the form:

- *operator operand*

A binary operation has the form:

- *operand<sub>1</sub> operator operand<sub>2</sub>*

Any expression contained in parentheses is treated as a data entity. Parentheses can be used to specify an explicit interpretation of an expression. They can also be used to restrict the alternative forms of the expression, which can help control the magnitude and accuracy of intermediate values during evaluation of the expression. For example, the two expressions



$$\begin{array}{l} (I*J)/K \\ I*(J/K) \end{array}$$

are mathematically equivalent, but may produce different computational values as a result of evaluation.

### Primary

A *primary* is the simplest form of an expression. It can be one of the following:

- A data object
- An array constructor
- A structure constructor

-  A complex constructor 
- A function reference
- An expression enclosed in parentheses

A primary that is a data object must not be an assumed-size array.

## Examples of primaries

```

12.3           ! Constant
'ABCDEFGH'(2:3) ! Subobject of a constant
VAR           ! Variable name
(/7.0,8.0/)   ! Array constructor
EMP(6,'SMITH') ! Structure constructor
SIN(X)       ! Function reference
(T-1)       ! Expression in parentheses

```

## Type, parameters, and shape

The type, type parameters, and shape of a primary are determined as follows:

- A data object or function reference acquires the type, type parameters, and shape of the object or function reference, respectively. The type, parameters, and shape of a generic function reference are determined by the type, parameters, and ranks of its actual arguments.
- A structure constructor is a scalar and its type is that of the constructor name.
- An array constructor has a shape determined by the number of constructor expressions, and its type and parameters are determined by those of the constructor expressions.
- A parenthesized expression acquires the type, parameters, and shape of the expression.

If a pointer appears as a primary in an operation in which it is associated with a nonpointer dummy argument, the target is referenced. The type, parameters, and shape of the primary are those of the target. If the pointer is not associated with a target, it can appear only as an actual argument in a procedure reference whose corresponding dummy argument is a pointer, or as the target in a pointer assignment statement. A disassociated pointer can also appear as an actual argument to the ASSOCIATED intrinsic inquiry function.

Given the operation  $[ \text{expr1} ] \text{op} \text{expr2}$ , the shape of the operation is the shape of  $\text{expr2}$  if  $\text{op}$  is unary or if  $\text{expr1}$  is a scalar. Otherwise, its shape is that of  $\text{expr1}$ .

The type and shape of an expression are determined by the operators and by the types and shapes of the expression's primaries. The type of the expression can be intrinsic or derived. An expression of intrinsic type has a kind parameter and, if it is of type character, it also has a length parameter.

---

## Constant expressions

A constant expression is an expression in which each operation is intrinsic and each primary is one of the following:

- A constant or a subobject of a constant.
- An array constructor where each element and the bounds and strides of each implied-DO are expressions whose primaries are either constant expressions or implied-DO variables.
- A structure constructor where each component is a constant expression.
- An elemental intrinsic function reference where each argument is a constant expression.

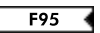
- A transformational intrinsic function reference where each argument is a constant expression.
-  A reference to the transformational intrinsic function `NULL`. 
- A reference to an array inquiry function (except `ALLOCATED`), a numeric inquiry function, the `BIT_SIZE` function, the `KIND`, `LEN`, or `NEW_LINE` function. Each argument is either a constant expression or it is a variable whose properties inquired about are not assumed, not defined by an expression that is not a constant expression, and not definable by an `ALLOCATE` or pointer assignment statement.
- A constant expression enclosed in parentheses.

## Examples of constant expressions

```
-48.9
name('Pat', 'Doe')
TRIM('ABC ')
(MOD(9,4)**3.5)
```

## Initialization expressions

An initialization expression is a constant expression, that is subject to all the same rules. In addition, the following rules apply to items that form primaries for initialization expressions:

- A constant or a subobject of a constant
- An array constructor in which each element and implied-`DO` control expression is an initialization expression
- A structure constructor in which each expression corresponding to an allocatable component is a reference to the intrinsic function `NULL`, and all other expressions are initialization expressions
- You can also specify any elemental intrinsic functions, where each argument is an initialization expression
- A reference to the vector intrinsic function `VEC_CONVERT` where each argument is an initialization expression
- You can reference any of the transformational intrinsic functions other than `NULL`, where each argument must be an initialization expression:
- A reference to the transformation intrinsic function `IEEE_SELECTED_REAL_KIND` from the intrinsic module `IEEE_ARITHMETIC`, where each argument is an initialization expression
- A reference to the transformational intrinsic function `NULL` that does not have an argument with a type parameter that is assumed or is defined by an expression that is not an initialization expression
- A specification inquiry where each designator or function argument is an initialization expression, or a variable whose properties inquired about are not:
  - assumed,
  - deferred, or
  - defined by an expression that is not an initialization expression
- An implied-`DO` variable within an array constructor in which each element and implied-`DO` control expression is an initialization expression
- An initialization expression enclosed in parentheses

If an initialization expression includes a specification inquiry that depends on a `TYPE` parameter or an array bound of an object specified in the same specification part, the type parameter or array bound must be specified in a prior specification

of the specification part. The prior specification can be to the left of the specification inquiry in the same statement, but must not be within the same entity declaration.

### Examples of initialization expressions

```
3.4**3  
KIND(57438)  
(/'desk','lamp'/)  
'ab'/'cd'/'ef'
```

### Example of an elemental intrinsic function, SIN, used in an initialization expression

```
integer, parameter :: foo = 42.0 * sin(0.5)
```

### Example of a transformational intrinsic function, CSHIFT, used in an initialization expression

```
integer, parameter :: a(3) = (/ 1, 2, 3 /)  
integer, parameter :: a_cshifted(3) = cshift(a,2)
```

---

## Specification expressions

A specification expression is an expression with limitations that you can use to specify items such as character lengths and array bounds.

A specification expression is a scalar, integer, restricted expression.

A *restricted expression* is an expression in which each operation is intrinsic and each primary is:

- A constant or a subobject of a constant.
- A variable that is a dummy argument that has neither the **OPTIONAL** nor the **INTENT(OUT)** attribute, or a subobject of such a variable.
- A variable that is in a common block, or a subobject of such a variable.
- A variable accessible by use association or host association, or a subobject of such a variable.
- An array constructor where each element and the bounds and strides of each implied-**DO** are expressions whose primaries are either restricted expressions or implied-**DO** variables.
- A structure constructor where each component is a restricted expression.
- A reference to an array inquiry function (except **ALLOCATED**), the bit inquiry function **BIT\_SIZE**, the character inquiry functions **LEN** and **NEW\_LINE**, the kind inquiry function **KIND**, an IEEE inquiry function, or a numeric inquiry function. Each argument is either a restricted expression, or it is a variable whose properties inquired about are not dependent on the upper bound of the last dimension of an assumed-size array, not defined by an expression that is not a restricted expression, or not definable by an **ALLOCATE** statement or by a pointer assignment statement.

---

### Fortran 95

- A reference to any remaining intrinsic functions defined in this document where each argument is a restricted expression.

---

### IBM Extension

- A reference to a system inquiry function, where any arguments are restricted expressions.

### End of IBM Extension

- Any subscript or substring expression must be a restricted expression.
- A reference to a specification function, where any arguments are restricted expressions.

---

### Fortran 95

You can use a *specification function* in a specification expression. A function is a specification function if it is a pure function that is not an intrinsic, internal or statement function. A specification function cannot have a dummy procedure argument.

### End of Fortran 95

A variable in a specification expression must have its type and type parameters, if any, specified by a previous declaration in the same scoping unit, or by the implicit typing rules in effect for the scoping unit, or by host or use association. If a variable in a specification expression is typed by the implicit typing rules, its appearance in any subsequent type declaration statement must confirm the implied type and type parameters.

If a specification expression includes a reference to an inquiry function for a type parameter or an array bound of an entity specified in the same specification part, the type parameter or array bound must be specified in a prior specification of the specification part. If a specification expression includes a reference to the value of an element of an array specified in the same specification part, the array bounds must be specified in a prior declaration. The prior specification can be to the left of the inquiry function in the same statement.

## Examples of specification expressions

```
LBOUND(C,2)+6    ! C is an assumed-shape dummy array
ABS(I)*J         ! I and J are scalar integer variables
276/NN(4)       ! NN is accessible through host association
```

---

### Fortran 95

The following example shows how a user-defined pure function, `fact`, can be used in the specification expression of an array-valued function result variable:

```
MODULE MOD
CONTAINS
  INTEGER PURE FUNCTION FACT(N)
    INTEGER, INTENT(IN) :: N
    ...
  END FUNCTION FACT
END MODULE MOD

PROGRAM P
  PRINT *, PERMUTE('ABCD')
CONTAINS
```

```

FUNCTION PERMUTE(ARG)
  USE MOD
  CHARACTER(*), INTENT(IN) :: ARG
  ...
  CHARACTER(LEN(ARG)) :: PERMUTE(FACT(LEN(ARG)))
  ...
END FUNCTION PERMUTE
END PROGRAM P

```

End of Fortran 95

## Operators and expressions

This section contains details on the XL Fortran expressions listed in the *XL Fortran Expressions* table. For information on the order of evaluation precedence see, How expressions are evaluated.

Table 14. XL Fortran expressions

Arithmetic	Logical
Character	Primary
General	Relational

### Arithmetic

An arithmetic expression (*arith\_expr*), when evaluated, produces a numeric value. The form of *arith\_expr* is:

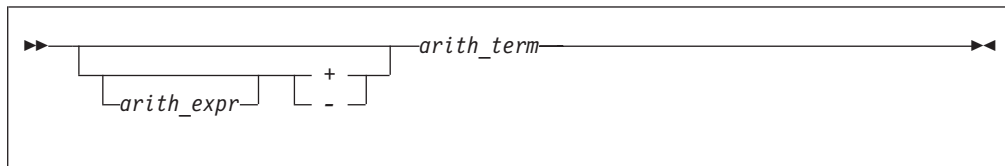

The form of *arith\_term* is:

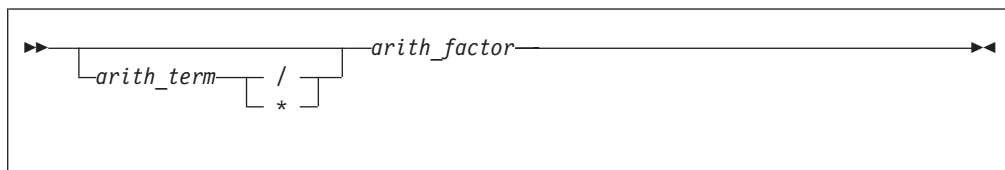

The form of *arith\_factor* is:

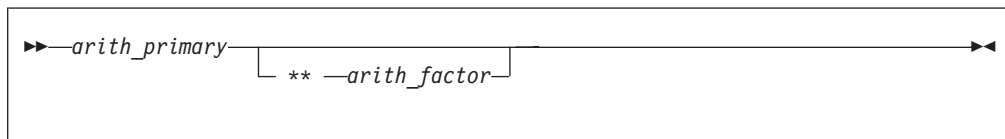

An *arith\_primary* is a primary of arithmetic type.

The following table shows the available arithmetic operators and the precedence each takes within an arithmetic expression.

Arithmetic Operator	Representation	Precedence
**	Exponentiation	First
*	Multiplication	Second
/	Division	Second
+	Addition or identity	Third
-	Subtraction or negation	Third

XL Fortran evaluates the terms from left to right when evaluating an arithmetic expression containing two or more addition or subtraction operators. For example,  $2+3+4$  is evaluated as  $(2+3)+4$ , although a processor can interpret the expression in another way if it is mathematically equivalent and respects any parentheses.

The factors are evaluated from left to right when evaluating a term containing two or more multiplication or division operators. For example,  $2*3*4$  is evaluated as  $(2*3)*4$ .

The primaries are combined from right to left when evaluating a factor containing two or more exponentiation operators. For example,  $2**3**4$  is evaluated as  $2**(3**4)$ . (Again, mathematical equivalents are allowed.)

The precedence of the operators determines the order of evaluation when XL Fortran is evaluating an arithmetic expression containing two or more operators having different precedence. For example, in the expression  $-A**3$ , the exponentiation operator ( $**$ ) has precedence over the negation operator ( $-$ ). Therefore, the operands of the exponentiation operator are combined to form an expression that is used as the operand of the negation operator. Thus,  $-A**3$  is evaluated as  $-(A**3)$ .

Note that expressions containing two consecutive arithmetic operators, such as  $A**-B$  or  $A*-B$ , are not allowed. You can use expressions such as  $A**(-B)$  and  $A*(-B)$ .

If an expression specifies the division of an integer by an integer, the result is rounded to an integer closer to zero. For example,  $(-7)/3$  has the value  $-2$ .

#### IBM Extension

For details of exception conditions that can arise during evaluation of floating-point expressions, see Detecting and trapping floating-point exceptions.

End of IBM Extension

### Examples of arithmetic expressions

Arithmetic Expression	Fully Parenthesized Equivalent
$-b**2/2.0$	$-(b**2)/2.0$
$i**(j**2)$	$i**(j**2)$
$a/b**2 - c$	$(a/(b**2)) - c$

### Data type of an arithmetic expression

Because the identity and negation operators operate on a single operand, the type of the resulting value is the same as the type of the operand.

The following table indicates the resulting type when an arithmetic operator acts on a pair of operands.

Notation:  $T(param)$ , where  $T$  is the data type (I: integer, R: real, X: complex) and  $param$  is the kind type parameter.

Table 15. Result types for binary arithmetic operators

first operand	second operand									
	I(1)	I(2)	I(4)	I(8)	R(4)	R(8)	R(16)	X(4)	X(8)	X(16)
I(1)	I(1)	I(2)	I(4)	I(8)	R(4)	R(8)	R(16)	X(4)	X(8)	X(16)
I(2)	I(2)	I(2)	I(4)	I(8)	R(4)	R(8)	R(16)	X(4)	X(8)	X(16)
I(4)	I(4)	I(4)	I(4)	I(8)	R(4)	R(8)	R(16)	X(4)	X(8)	X(16)
I(8)	I(8)	I(8)	I(8)	I(8)	R(4)	R(8)	R(16)	X(4)	X(8)	X(16)
R(4)	R(4)	R(4)	R(4)	R(4)	R(4)	R(8)	R(16)	X(4)	X(8)	X(16)
R(8)	R(8)	R(8)	R(8)	R(8)	R(8)	R(8)	R(16)	X(8)	X(8)	X(16)
R(16)	R(16)	R(16)	R(16)	R(16)	R(16)	R(16)	R(16)	X(16)	X(16)	X(16)
X(4)	X(4)	X(4)	X(4)	X(4)	X(4)	X(8)	X(16)	X(4)	X(8)	X(16)
X(8)	X(8)	X(8)	X(8)	X(8)	X(8)	X(8)	X(16)	X(8)	X(8)	X(16)
X(16)	X(16)	X(16)	X(16)	X(16)	X(16)	X(16)	X(16)	X(16)	X(16)	X(16)

### IBM Extension

#### Notes:

- If you do not specify `-qfloat=rndsngl`, XL Fortran implements **REAL(4)** operations using **REAL(8)** internal precision. If you specify `-qfloat=rndsngl`, XL Fortran implements **REAL(4)** operations using **REAL(4)** internal precision. See Detecting and trapping floating-point exceptions in the *XL Fortran Optimization and Programming Guide* for details on modifying this implementation. **REAL(16)** values must only be used in round to nearest mode. The rounding mode can only be changed at the beginning and end of a subprogram. It cannot be changed across a subprogram call; and if it is changed within a subprogram, it must be restored before control is returned to the calling routine.
- XL Fortran implements integer operations using **INTEGER(4)** arithmetic, or **INTEGER(8)** arithmetic if data items are 8 bytes in length. If the intermediate result is used in a context requiring **INTEGER(1)** or **INTEGER(2)** data type, it is converted as required.

```

INTEGER(2) I2_1, I2_2, I2_RESULT
INTEGER(4) I4
I2_1 = 32767           ! Maximum I(2)
I2_2 = 32767           ! Maximum I(2)
I4 = I2_1 + I2_2
PRINT *, "I4=", I4     ! Prints I4=-2

I2_RESULT = I2_1 + I2_2 ! Assignment to I(2) variable
I4 = I2_RESULT         ! and then assigned to an I(4)
PRINT *, "I4=", I4     ! Prints I4=-2
END

```

### End of IBM Extension

## Character

A character expression, when evaluated, produces a result of type character. The form of *char\_expr* is:



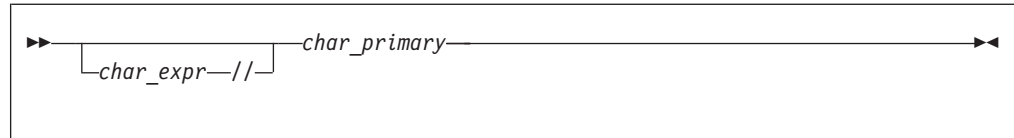

*char\_primary* is a primary of type character. All character primaries in the expression must have the same kind type parameter, which is also the kind type parameter of the result.

The only character operator is //, representing concatenation.

In a character expression containing one or more concatenation operators, the primaries are joined to form one string whose length is equal to the sum of the lengths of the individual primaries. For example, 'AB' //'CD' //'EF' evaluates to 'ABCDEF', a string 6 characters in length.

Parentheses have no effect on the value of a character expression.

A character expression can include concatenation of an operand when you declare the length with an asterisk in parentheses. This indicates inherited length. In this case, the actual length depends on whether you use the inherited length character string to declare:

- A dummy argument specified in a **FUNCTION**, **SUBROUTINE**, or **ENTRY** statement. The length of the dummy argument assumes the length of the associated actual argument on invocation.
- A named constant. The character expression takes on the length of the constant value.
- The length of an external function result. The calling scoping unit must not declare the function name with an asterisk. On invocation, the length of the function result assumes this defined length.

### Example of a character expression

```
CHARACTER(7)  FIRSTNAME, LASTNAME
FIRSTNAME='Martha'
LASTNAME='Edwards'
PRINT *, LASTNAME//', '//'FIRSTNAME      ! Output:'Edwards, Martha'
END
```

## General

The general form of an expression (*general\_expr*) is:

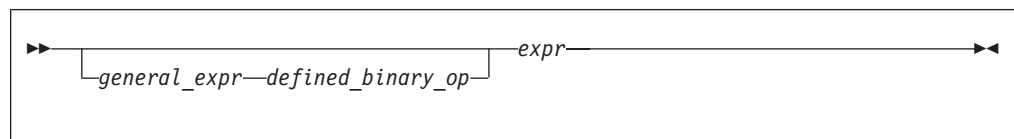

*defined\_binary\_op*

is a defined binary operator. See “Extended intrinsic and defined operations” on page 106.

*expr*

is one of the kinds of expressions defined below.

There are four kinds of intrinsic expressions: arithmetic, character, relational, and logical.

## Logical

A logical expression (*logical\_expr*), when evaluated, produces a result of type logical. The form of a logical expression is:

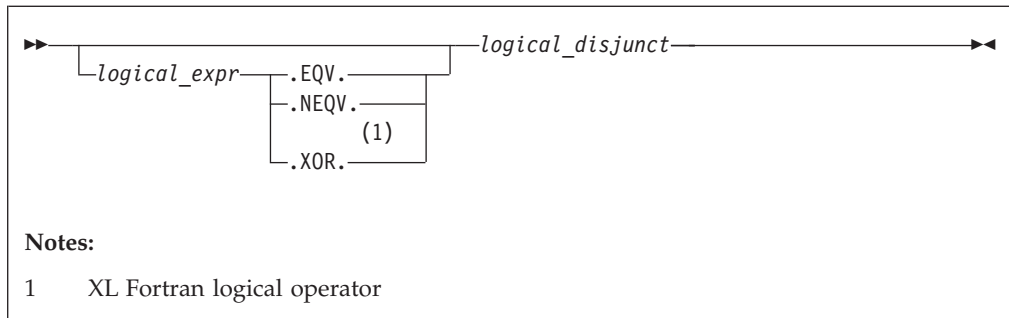

The form of a *logical\_disjunct* is:

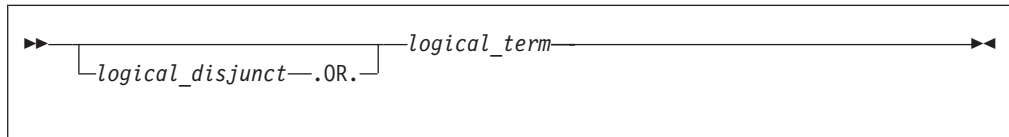

The form of a *logical\_term* is:

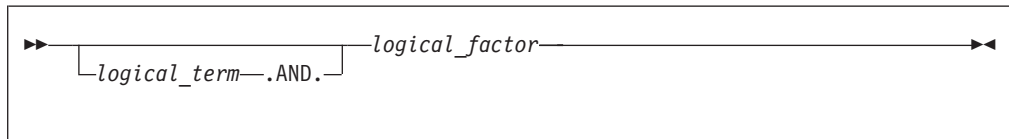

The form of a *logical\_factor* is:

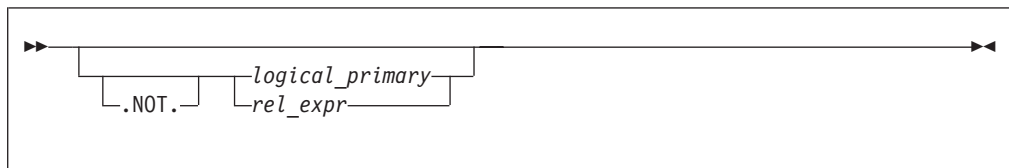

*logical\_primary* is a primary of type logical.

*rel\_expr* is a relational expression.

The logical operators are:

Logical Operator	Representing	Precedence
.NOT.	Logical negation	First (highest)
.AND.	Logical conjunction	Second
.OR.	Logical inclusive disjunction	Third
.XOR. <b>1</b>	Logical exclusive disjunction	Fourth (lowest)
.EQV.	Logical equivalence	Fourth (lowest)
.NEQV.	Logical nonequivalence	Fourth (lowest)

**Notes:**

1. XL Fortran logical operator.

<b>IBM Extension</b>
----------------------

The **.XOR.** operator is treated as an intrinsic operator only when the **-qxlf77=intxor** compiler option is specified. (See the **-qxlf77** Option in the *XL Fortran Compiler Reference* for details.) Otherwise, it is treated as a defined operator. If it is treated as an intrinsic operator, it can also be extended by a generic interface.

<b>End of IBM Extension</b>
-----------------------------

The precedence of the operators determines the order of evaluation when a logical expression containing two or more operators having different precedences is evaluated. For example, evaluation of the expression **A.OR.B.AND.C** is the same as evaluation of the expression **A.OR.(B.AND.C)**.

**Value of a logical expression**

Given that **x1** and **x2** represent logical values, use the following tables to determine the values of logical expressions:

x1	.NOT. x1
True	False
False	True

x1	x2	.AND.	.OR.	.XOR.	.EQV.	.NEQV.
False	False	False	False	False	True	False
False	True	False	True	True	False	True
True	False	False	True	True	False	True
True	True	True	True	False	True	False

Sometimes a logical expression does not need to be completely evaluated to determine its value. Consider the following logical expression (assume that **LFCT** is a function of type logical):

**A .LT. B .OR. LFCT(Z)**

If **A** is less than **B**, the evaluation of the function reference is not required to determine that this expression is true.

XL Fortran evaluates a logical expression to a **LOGICAL(n)** or **INTEGER(n)** result, where **n** is the kind type parameter. The value of **n** depends on the kind parameter of each operand.

By default, for the unary logical operator **.NOT.**, **n** will be the same as the kind type parameter of the operand. For example, if the operand is **LOGICAL(2)**, the result will also be **LOGICAL(2)**.

The following table shows the resultant type for unary operations:

OPERAND	RESULT of Unary Operation
BYTE <b>1</b>	INTEGER(1) <b>1</b>

OPERAND	RESULT of Unary Operation
LOGICAL(1)	LOGICAL(1)
LOGICAL(2)	LOGICAL(2)
LOGICAL(4)	LOGICAL(4)
LOGICAL(8)	LOGICAL(8)
Typeless <b>1</b>	Default integer <b>1</b>

**Notes:**

1. IBM Extension

If the operands are of the same length, n will be that length.

<b>IBM Extension</b>
For binary logical operations with operands that have different kind type parameters, the kind type parameter of the expression is the same as the larger length of the two operands. For example, if one operand is <b>LOGICAL(4)</b> and the other <b>LOGICAL(2)</b> , the result will be <b>LOGICAL(4)</b> .
<b>End of IBM Extension</b>

The following table shows the resultant type for binary operations:

Table 16. Result Types for binary logical expressions

first operand	second operand					
	*BYTE	LOGICAL(1)	LOGICAL(2)	LOGICAL(4)	LOGICAL(8)	*Typeless
*BYTE	*INTEGER(1)	*LOGICAL(1)	*LOGICAL(2)	*LOGICAL(4)	*LOGICAL(8)	*INTEGER(1)
LOGICAL(1)	LOGICAL(1)	LOGICAL(1)	LOGICAL(2)	LOGICAL(4)	LOGICAL(8)	LOGICAL(1)
LOGICAL(2)	LOGICAL(2)	LOGICAL(2)	LOGICAL(2)	LOGICAL(4)	LOGICAL(8)	LOGICAL(2)
LOGICAL(4)	LOGICAL(4)	LOGICAL(4)	LOGICAL(4)	LOGICAL(4)	LOGICAL(8)	LOGICAL(4)
LOGICAL(8)	LOGICAL(8)	LOGICAL(8)	LOGICAL(8)	LOGICAL(8)	LOGICAL(8)	LOGICAL(8)
*Typeless	*INTEGER(1)	*LOGICAL(1)	*LOGICAL(2)	*LOGICAL(4)	*LOGICAL(8)	*Default Integer

**Note:** \* Resultant types for binary logical expressions in XL Fortran

If the expression result is to be treated as a default integer but the value cannot be represented within the value range for a default integer, the constant is promoted to a representable kind.

## Primary

The form of a primary expression is:

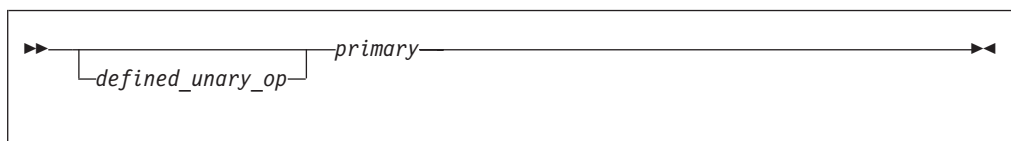

*defined\_unary\_op*

is a defined unary operator. See “Extended intrinsic and defined operations” on page 106.

## Relational

A relational expression (*rel\_expr*), when evaluated, produces a result of type logical, and can appear wherever a logical expression can appear. It can be an arithmetic relational expression or a character relational expression.

### Arithmetic relational expressions

An arithmetic relational expression compares the values of two arithmetic expressions. Its form is:

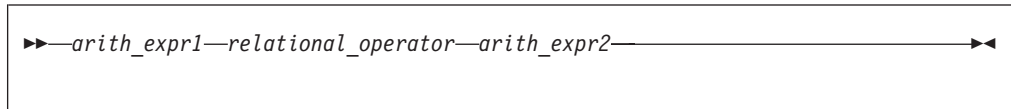

*arith\_expr1* and **arith\_expr2**

are each an arithmetic expression. Complex expressions can only be specified if *relational\_operator* is **.EQ.**, **.NE.**, **<>**, **==**, or **/=**.

*relational\_operator*

is any of:

Relational Operator	Representing
.LT. or <	Less than
.LE. or <=	Less than or equal to
.EQ. or ==	Equal to
.NE. or *<> or /=	Not equal to
.GT. or >	Greater than
.GE. or >=	Greater than or equal to

**Note:** \* XL Fortran relational operator.

An arithmetic relational expression is interpreted as having the logical value **.true.** if the values of the operands satisfy the relation specified by the operator. If the operands do not satisfy the specified relation, the expression has the logical value **.false.**

If the types or kind type parameters of the expressions differ, their values are converted to the type and kind type parameter of the expression (*arith\_expr1* + *arith\_expr2*) before evaluation.

**Example of an arithmetic relational expression:**

```
IF (NODAYS .GT. 365) YEARTYPE = 'leapyear'
```

### Character relational expressions

A character relational expression compares the values of two character expressions. Its form is:

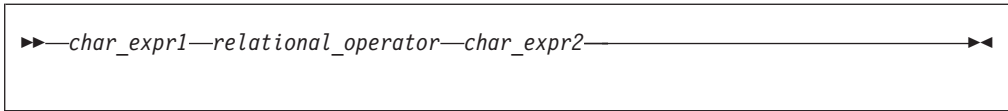

*char\_expr1* and *char\_expr2*  
are each character expressions

*relational\_operator*  
is any of the relational operators described in “Arithmetic relational expressions” on page 105.

For all relational operators, the collating sequence is used to interpret a character relational expression. The character expression whose value is lower in the collating sequence is less than the other expression. The character expressions are evaluated one character at a time from left to right. You can also use the intrinsic functions (**LGE**, **LLT**, and **LLT**) to compare character strings in the order specified by the ASCII collating sequence. For all relational operators, if the operands are of unequal length, the shorter is extended on the right with blanks. If both *char\_expr1* and *char\_expr2* are of zero length, they are evaluated as equal.

**IBM Extension**

Even if *char\_expr1* and *char\_expr2* are multibyte characters (MBCS) in XL Fortran, the ASCII collating sequence is still used.

**End of IBM Extension**

**Example of a character relational expression:**

```
IF (CHARIN .GT. '0' .AND. CHARIN .LE. '9') CHAR_TYPE = 'digit'
```

---

## Extended intrinsic and defined operations

A defined operation is either a defined unary operation or a defined binary operation. It is defined by a function and a generic interface (see “Interface blocks” on page 158 and “Type-bound procedures” on page 58). A defined operation is not an intrinsic operation, although an intrinsic operator can be extended in a defined operation. For example, to add two objects of derived type, you can extend the meaning of the intrinsic binary operator for addition (+). If an extended intrinsic operator has typeless operands, the operation is evaluated intrinsically.

The operand of a unary intrinsic operation that is extended must not have a type that is required by the intrinsic operator. Either or both of the operands of a binary intrinsic operator that is extended must not have the types or ranks that are required by the intrinsic operator.

The defined operator of a defined operation must be defined in a generic interface.

A defined operator is an extended intrinsic operator or has the form:

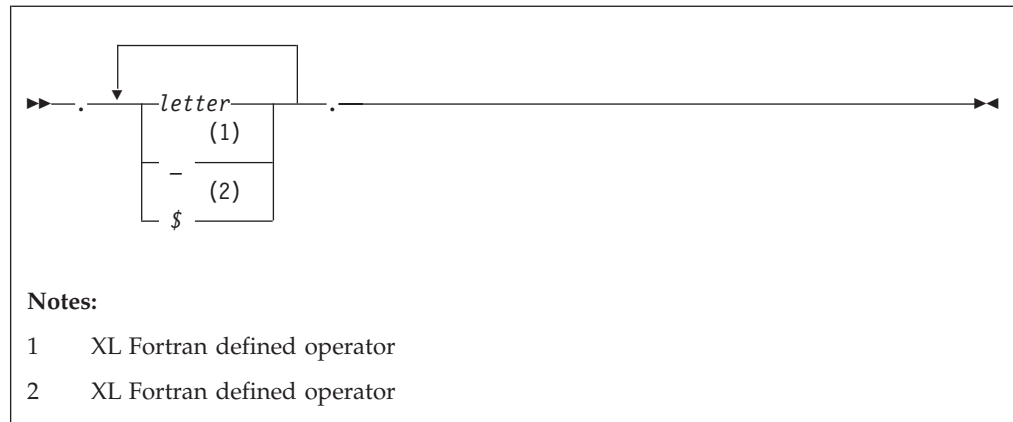

In Fortran 90 and Fortran 95, a defined operator must not contain more than 31 letters, and must not be the same as any intrinsic operator or logical literal constant. In Fortran 2003 the letter limit for a defined operator is 63.

See “Generic interface blocks” on page 161 for details on defining and extending operators in an interface block. See “Type-bound procedures” on page 58 for details on defining and extending operators that are bound to a derived type.

## How expressions are evaluated

### Precedence of operators

An expression can contain more than one kind of operator. When it does, the expression is evaluated from left to right, according to the following precedence among operators:

1. Defined unary
2. Arithmetic
3. Character
4. Relational
5. Logical
6. Defined binary

For example, the logical expression:

L .OR. A + B .GE. C

where L is of type logical, and A, B, and C are of type real, is evaluated the same as the logical expression below:

L .OR. ((A + B) .GE. C)

An extended intrinsic operator maintains its precedence. That is, the operator does not have the precedence of a defined unary operator or a defined binary operator.

### Summary of interpretation rules

Primaries that contain operators are combined in the following order:

1. Use of parentheses
2. Precedence of the operators
3. Right-to-left interpretation of exponentiations in a factor
4. Left-to-right interpretation of multiplications and divisions in a term

5. Left-to-right interpretation of additions and subtractions in an arithmetic expression
6. Left-to-right interpretation of concatenations in a character expression
7. Left-to-right interpretation of conjunctions in a logical term
8. Left-to-right interpretation of disjunctions in a logical disjunct
9. Left-to-right interpretation of logical equivalences in a logical expression

### Evaluation of expressions

Arithmetic, character, relational, and logical expressions are evaluated according to the following rules:

- A variable or function must be defined at the time it is used. You must define an integer operand with an integer value, not a statement label value. All referenced characters in a character data object or referenced array elements in an array or array section must be defined at the time the reference is made. All components of a structure must be defined when a structure is referenced. A pointer must be associated with a defined target.

Execution of an array element reference, array section reference, and substring reference requires the evaluation of its subscript, section subscript and substring expressions. Evaluation of any array element subscript, section subscript, substring expression, or the bounds and stride of any array constructor implied-**DO** does not affect, nor is it affected by, the type of the containing expression. See “Expressions involving arrays” on page 90. You cannot use any constant integer operation or floating-point operation whose result is not mathematically defined in an executable program. If such expressions are nonconstant and are executed, they are detected at run time. (Examples are dividing by zero and raising a zero-valued primary to a zero-valued or negative-valued power.) As well, you cannot raise a negative-valued primary of type real to a real power.

- The invocation of a function in a statement must not affect, or be affected by, the evaluation of any other entity within the statement in which the function reference appears. When the value of an expression is true, invocation of a function reference in the expression of a logical **IF** statement or a **WHERE** statement can affect entities in the statement that is executed. If a function reference causes definition or undefinition of an actual argument of the function, that argument or any associated entities must not appear elsewhere in the same statement. For example, you cannot use the statements:

```
A(I) = FUNC1(I)
Y = FUNC2(X) + X
```

if the reference to **FUNC1** defines **I** or the reference to **FUNC2** defines **X**.

The data type of an expression in which a function reference appears does not affect, nor is it affected by, the evaluation of the actual arguments of the function.

- An argument to a statement function reference must not be altered by evaluating that reference.

---

#### IBM Extension

---

Several compiler options affect the data type of the final result:

- When you use the **-qintlog** compiler option, you can mix integer and logical values in expressions and statements. The data type and kind type parameter of the result depends on the operands and the operator involved. In general:



- For unary logical operators (**.NOT.**) and arithmetic unary operators (**+, -**):

Data Type of OPERAND	Data Type of RESULT of Unary Operation
BYTE	INTEGER(1)
INTEGER(n)	INTEGER(n)
LOGICAL(n)	LOGICAL(n)
Typeless	Default integer

where n represents the kind type parameter. n must not be replaced with a logical constant even if **-qintlog** is on, nor by a character constant even if **-qctyp1ss** is on, nor can it be a typeless constant. In the case of **INTEGER** and **LOGICAL** data types, the length of the result is the same as the kind type parameter of the operand.

- For binary logical operators (**.AND.**, **.OR.**, **.XOR.**, **.EQV.**, **.NEQV.**) and arithmetic binary operators (**\*\***, **\***, **/**, **+**, **-**), the following table summarizes what data type the result has:

first operand	second operand			
	BYTE	INTEGER(y)	LOGICAL(y)	Typeless
BYTE	INTEGER(1)	INTEGER(y)	LOGICAL(y)	INTEGER(1)
INTEGER(x)	INTEGER(x)	INTEGER(z)	INTEGER(z)	INTEGER(x)
LOGICAL(x)	LOGICAL(x)	INTEGER(z)	LOGICAL(z)	LOGICAL(x)
Typeless	INTEGER(1)	INTEGER(y)	LOGICAL(y)	Default integer

**Note:** z is the kind type parameter of the result such that z is equal to the greater of x and y. For example, a logical expression with a **LOGICAL(4)** operand and an **INTEGER(2)** operand has a result of **INTEGER(4)**.

For binary logical operators (**.AND.**, **.OR.**, **.XOR.**, **.EQV.**, **.NEQV.**), the result of a logical operation between an integer operand and a logical operand or between two integer operands will be integer. The kind type parameter of the result will be the same as the larger kind parameter of the two operands. If the operands have the same kind parameter, the result has the same kind parameter.

- When you use the **-qlog4** compiler option and the default integer size is **INTEGER(4)**, logical results of logical operations will have type **LOGICAL(4)**, instead of **LOGICAL(n)** as specified in the table above. If you specify the **-qlog4** option and the default integer size is not **INTEGER(4)**, the results will be as specified in the table above.
- When you specify the **-qctyp1ss** compiler option, XL Fortran treats character constant expressions as Hollerith constants. If one or both operands are character constant expressions, the data type and the length of the result are the same as if the character constant expressions were Hollerith constants. See the "Typeless" rows in the previous tables for the data type and length of the result.

See *Summary of compiler options by functional category* and *Detailed descriptions of the XL Fortran compiler options* in the *XL Fortran Compiler Reference* for information about compiler options.

End of IBM Extension

## Using BYTE data objects

### IBM Extension

Data objects of type **BYTE** can be used wherever a **LOGICAL(1)**, **CHARACTER(1)**, or **INTEGER(1)** data object can be used.

The data types of **BYTE** data objects are determined by the context in which you use them. XL Fortran does not convert them before use. For example, the type of a named constant is determined by use, not by the initial value assigned to it.

- When you use a **BYTE** data object as an operand of an arithmetic, logical, or relational binary operator, the data object assumes:
  - An **INTEGER(1)** data type if the other operand is arithmetic, **BYTE**, or a typeless constant
  - A **LOGICAL(1)** data type if the other operand is logical
  - A **CHARACTER(1)** data type if the other operand is character
- When you use a **BYTE** data object as an operand of the concatenation operator, the data object assumes a **CHARACTER(1)** data type.
- When you use a **BYTE** data object as an actual argument to a procedure with an explicit interface, the data object assumes the type of the corresponding dummy argument:
  - **INTEGER(1)** for an **INTEGER(1)** dummy argument
  - **LOGICAL(1)** for a **LOGICAL(1)** dummy argument
  - **CHARACTER(1)** for a **CHARACTER(1)** dummy argument
- When you use a **BYTE** data object as an actual argument passed by reference to an external subprogram with an implicit interface, the data object assumes a length of 1 byte and no data type.
- When you use a **BYTE** data object as an actual argument passed by value (**VALUE** attribute), the data object assumes an **INTEGER(1)** data type.
- When you use a **BYTE** data object in a context that requires a specific data type, which is arithmetic, logical, or character, the data object assumes an **INTEGER(1)**, **LOGICAL(1)**, or **CHARACTER(1)** data type, respectively.
- A pointer of type **BYTE** cannot be associated with a target of type character, nor can a pointer of type character be associated with a target of type **BYTE**.
- When you use a **BYTE** data object in any other context, the data object assumes an **INTEGER(1)** data type.

### End of IBM Extension

---

## Intrinsic assignment

Assignment statements are executable statements that define or redefine variables based on the result of expression evaluation.

A defined assignment is not intrinsic, and is defined by a subroutine and an interface. See “Defined assignment” on page 165.

The general form of an intrinsic assignment is:

▶—*variable*— = —*expression*—▶

**Fortran 2003**

The shapes of *variable* and *expression* must conform unless *variable* is an allocatable array. If *variable* is an allocatable array, and `-qxlf2003=autorealloc` has been specified, then *variable* and *expression* must not be arrays of different ranks.

**End of Fortran 2003**

*variable* must be an array if *expression* is an array (see “Expressions involving arrays” on page 90). If *expression* is a scalar and *variable* is an array, *expression* is treated as an array of the same shape as *variable*, with every array element having the same value as the scalar value of *expression*. *variable* must not be a many-one array section (see “Vector subscripts” on page 85 for details), and neither *variable* nor *expression* can be an assumed-size array. The types of *variable* and *expression* must conform as follows:

Type of <i>variable</i>	Type of <i>expression</i>
Numeric	Numeric
Logical	Logical
Character	Character
Derived type	Derived type (same as <i>variable</i> )

In numeric assignment statements, *variable* and *expression* can specify different numeric types and different kind type parameters. For logical assignment statements, the kind type parameters can differ. For character assignment statements, the length type parameters can differ.

If the length of a character variable is greater than the length of a character expression, the character expression is extended on the right with blanks until the lengths are equal. If the length of the character variable is less than the character expression, the character expression is truncated on the right to match the length of the character variable.

If *variable* is a pointer, it must be associated with a definable target that has type, type parameters and shape that conform with those of *expression*. The value of *expression* is then assigned to the target associated with *variable*.

Both *variable* and *expression* can contain references to any portion of *variable*.

**Fortran 2003**

If *variable* is an allocated allocatable variable, it is deallocated if *expression* is an array of different shape or any of the corresponding length type parameter values of *variable* and *expression* differ. If *variable* is or becomes an unallocated allocatable variable, then it is allocated with each deferred type parameter equal to the corresponding type parameters of *expression*, with the shape of *expression*, and with each lower bound equal to the corresponding element of `LBOUND(expression)`

Specify `-qxlf2003=autorealloc` for reallocation support. See the `-qxlf2003=autorealloc` option in the *XL Fortran Compiler Reference* for more information

---

**End of Fortran 2003**

---

An assignment statement causes the evaluation of *expression* and all expressions within *variable* before assignment, the possible conversion of *expression* to the type and type parameters of *variable*, and the definition of *variable* with the resulting value. No value is assigned to *variable* if it is a zero-length character object or a zero-sized array.

A derived-type assignment statement is an intrinsic assignment statement if there is no accessible defined assignment for objects of this derived type. The derived type expression must be of the same declared type as the variable. See “Determining declared type for derived types” on page 66 for the rules that determine when two structures are of the same derived type. Assignment is performed as if each component of the expression is assigned to the corresponding component of the variable. Pointer assignment is executed for pointer components, defined assignment is performed for each nonpointer nonallocatable component of a type that has a defined assignment consistent with the component, and intrinsic assignment is performed for each other nonpointer nonallocatable component. For an allocatable component the following sequence of operations is applied:

1. If the component of *variable* is currently allocated, it is deallocated.
2. If the component of *expression* is currently allocated, the corresponding component of *variable* is allocated with the same type and type parameters as the component of *expression*. If it is an array, it is allocated with the same bounds.
3. The value of the component of *expression* is then assigned to the corresponding component of *variable* using:
  - Defined assignment if the declared type of the component has a defined assignment consistent with the component.
  - Intrinsic assignment for the dynamic type of that component otherwise.

When *variable* is a subobject, the assignment does not affect the definition status or value of other parts of the object.

## Arithmetic conversion

For numeric intrinsic assignment, the value of *expression* may be converted to the type and kind type parameter of *variable*, as specified in the following table:

Type of <i>variable</i>	Value Assigned
Integer	INT( <i>expression</i> ,KIND=KIND( <i>variable</i> ))
Real	REAL( <i>expression</i> ,KIND=KIND( <i>variable</i> ))
Complex	CMPLX( <i>expression</i> ,KIND=KIND( <i>variable</i> ))

---

**IBM Extension**

---

**Note:** Arithmetic integer operations for **INTEGER(8)** data items, including intermediate results, are performed using **INTEGER(8)** arithmetic in both 32-bit and 64-bit mode. Arithmetic integer operations for **INTEGER(1)**, **INTEGER(2)**, and **INTEGER(4)** data objects, including intermediate results, are performed using **INTEGER(4)** arithmetic in 32-bit mode and

INTEGER(8) arithmetic in 64-bit mode. If an intermediate result is used in a context requiring a smaller integer size, it is converted as required.

End of IBM Extension

## Character assignment

Only as much of the character expression as is necessary to define the character variable needs to be evaluated. For example:

```
CHARACTER SCOTT*4, DICK*8
SCOTT = DICK
```

This assignment of DICK to SCOTT requires only that you have previously defined the substring DICK(1:4). You do not have to previously define the rest of DICK (DICK(5:8)).

## BYTE assignment

IBM Extension

If *expression* is of an arithmetic type, arithmetic assignment is used. Similarly, if *expression* is of type character, character assignment is used, and if *expression* is of type logical, logical assignment is used. If the expression on the right is of type **BYTE**, arithmetic assignment is used.

End of IBM Extension

## Examples of Intrinsic Assignment:

```
INTEGER I(10)
LOGICAL INSIDE
REAL R,RMIN,RMAX
REAL :: A=2.3,B=4.5,C=6.7
TYPE PERSON
  INTEGER(4) P_AGE
  CHARACTER(20) P_NAME
END TYPE
TYPE (PERSON) EMP1, EMP2
CHARACTER(10) :: CH = 'ABCDEFGHIJ'

I = 5                      ! All elements of I assigned value of 5

RMIN = 28.5 ; RMAX = 29.5
R = (-B + SQRT(B**2 - 4.0*A*C))/(2.0*A)
INSIDE = (R .GE. RMIN) .AND. (R .LE. RMAX)

CH(2:4) = CH(3:5)          ! CH is now 'ACDEEFGHIJ'

EMP1 = PERSON(45, 'Frank Jones')
EMP2 = EMP1

! EMP2%P_AGE is assigned EMP1%P_AGE using arithmetic assignment
! EMP2%P_NAME is assigned EMP1%P_NAME using character assignment

END
```

---

## WHERE construct

The **WHERE** construct masks the evaluation of expressions and assignments of values in array assignment statements. It does this according to the value of a logical array expression.

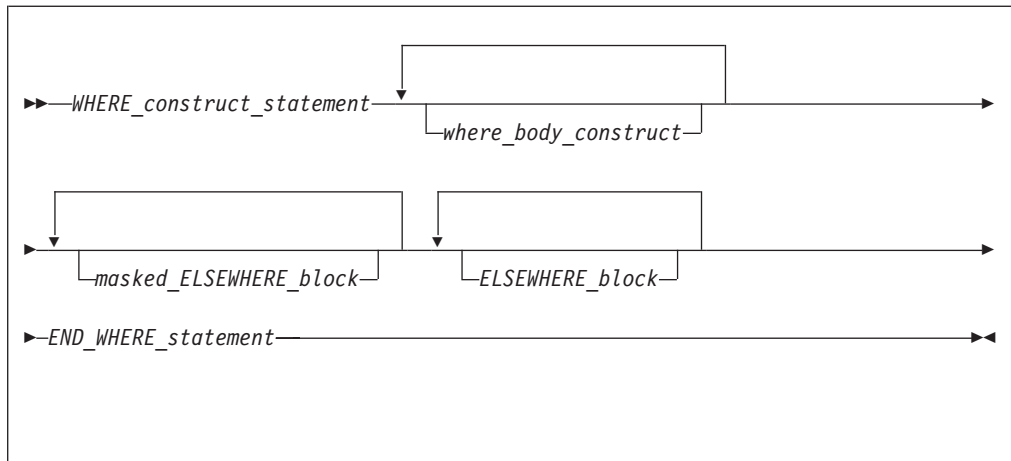

*WHERE\_construct\_statement*

See “WHERE” on page 478 for syntax details.

*where\_body\_construct*



*where\_assignment\_statement*

Is an *assignment\_statement*.

**Fortran 95**

*masked\_ELSEWHERE\_block*

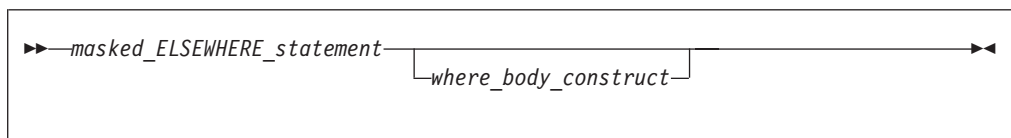

*masked\_ELSEWHERE\_statement*

Is an **ELSEWHERE** statement that specifies a *mask\_expr*. See “ELSEWHERE” on page 333 for syntax details.

**End of Fortran 95**

*ELSEWHERE\_block*

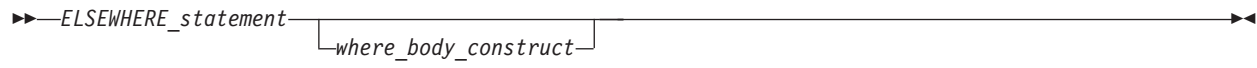

#### *ELSEWHERE\_statement*

Is an **ELSEWHERE** statement that does not specify a *mask\_expr*. See “ELSEWHERE” on page 333 for syntax details.

#### *END\_WHERE\_statement*

See “END (Construct)” on page 336 for syntax details.

#### Rules:

- *mask\_expr* is a logical array expression.
- In each *where\_assignment\_statement*, the *mask\_expr* and the *variable* being defined must be arrays of the same shape.
- A statement that is part of a *where\_body\_construct* must not be a branch target statement. Also, **ELSEWHERE**, masked **ELSEWHERE**, and **END WHERE** statements must not be branch target statements.



#### Fortran 95

- A *where\_assignment\_statement* that is a defined assignment must be an elemental defined assignment.
- The *mask\_expr* on the **WHERE** construct statement and all corresponding masked **ELSEWHERE** statements must have the same shape. The *mask\_expr* on a nested **WHERE** statement or nested **WHERE** construct statement must have the same shape as the *mask\_expr* on the **WHERE** construct statement of the construct in which it is nested.
- If a construct name appears on a **WHERE** construct statement, it must also appear on the corresponding **END WHERE** statement. A construct name is optional on the masked **ELSEWHERE** and **ELSEWHERE** statements in the **WHERE** construct.

#### End of Fortran 95

## Interpreting masked array assignments

To understand how to interpret masked array assignments, you need to understand the concepts of a *control mask* ( $m_c$ ) and a *pending control mask* ( $m_p$ ):

- The  $m_c$  is an array of type logical whose value determines which elements of an array in a *where\_assignment\_statement* will be defined. This value is determined by the execution of one of the following:
  - a **WHERE** statement
  - a **WHERE** construct statement
  - an **ELSEWHERE** statement
  -  a masked **ELSEWHERE** statement 
  - an **END WHERE** statement

The value of  $m_c$  is cumulative; the compiler determines the value using the mask expressions of surrounding **WHERE** statements and the current mask expression. Subsequent changes to the value of entities in a *mask\_expr* have no

effect on the value of  $m_c$ . The compiler evaluates the *mask\_expr* only once for each **WHERE** statement, **WHERE** construct statement, or **F95** masked **ELSEWHERE** statement. **F95**

- The  $m_p$  is a logical array that provides information to the next masked assignment statement at the same nesting level on the array elements not defined by the current **WHERE** statement, **WHERE** construct statement, **F95** or masked **ELSEWHERE** statement. **F95**

The following describes how the compiler interprets statements in a **WHERE**, **WHERE** construct, **F95** masked **ELSEWHERE**, **ELSEWHERE**, or **END WHERE** statement. It describes the effect on  $m_c$  and  $m_p$  and any further behavior of the statements, in order of occurrence.

- **WHERE** statement

**Fortran 95**

– If the **WHERE** statement is nested in a **WHERE** construct, the following occurs:

1.  $m_c$  becomes  $m_c$  **.AND.** *mask\_expr*.
2. After the compiler executes the **WHERE** statement,  $m_c$  has the value it had prior to the execution of the **WHERE** statement.

**End of Fortran 95**

– Otherwise,  $m_c$  becomes the *mask\_expr*.

- **WHERE** construct

**Fortran 95**

– If the **WHERE** construct is nested in another **WHERE** construct, the following occurs:

1.  $m_p$  becomes  $m_c$  **.AND.** (**.NOT.** *mask\_expr*).
2.  $m_c$  becomes  $m_c$  **.AND.** *mask\_expr*.

**End of Fortran 95**

– Otherwise:

1. The compiler evaluates the *mask\_expr*, and assigns  $m_c$  the value of that *mask\_expr*.
2.  $m_p$  becomes **.NOT.** *mask\_expr*.

**Fortran 95**

- Masked **ELSEWHERE** statement

The following occurs:

1.  $m_c$  becomes  $m_p$ .
2.  $m_p$  becomes  $m_c$  **.AND.** (**.NOT.** *mask\_expr*).
3.  $m_c$  becomes  $m_c$  **.AND.** *mask\_expr*.

**End of Fortran 95**

- **ELSEWHERE** statement

The following occurs:



1.  $m_c$  becomes  $m_p$ . No new  $m_p$  value is established.

- **END WHERE** statement

After the compiler executes an **END WHERE** statement,  $m_c$  and  $m_p$  have the values they had prior to the execution of the corresponding **WHERE** construct statement.

- *where\_assignment\_statement*

The compiler assigns the values of the *expr* that correspond to the true values of  $m_c$  to the corresponding elements of the *variable*.

If a non-elemental function reference occurs in the *expr* or *variable* of a *where\_assignment\_statement* or in a *mask\_expr*, the compiler evaluates the function without any masked control; that is, it fully evaluates all of the function's argument expressions and then it fully evaluates the function. If the result is an array and the reference is not within the argument list of a non-elemental function, the compiler selects elements corresponding to true values in  $m_c$  for use in evaluating the *expr*, *variable*, or *mask\_expr*.

If an elemental intrinsic operation or function reference occurs in the *expr* or *variable* of a *where\_assignment\_statement* or in a *mask\_expr*, and is not within the argument list of a non-elemental function reference, the compiler performs the operation or evaluates the function only for the elements corresponding to true values in  $m_c$ .

If an array constructor appears in a *where\_assignment\_statement* or in a *mask\_expr*, the compiler evaluates the array constructor without any masked control and then executes the *where\_assignment\_statement* or evaluates the *mask\_expr*.

The execution of a function reference in the *mask\_expr* of a **WHERE** statement is allowed to affect entities in the *where\_assignment\_statement*. Execution of an **END WHERE** has no effect.

The following example shows how control masks are updated. In this example, *mask1*, *mask2*, *mask3*, and *mask4* are conformable logical arrays,  $m_c$  is the control mask, and  $m_p$  is the pending control mask. The compiler evaluates each mask expression once.

Sample code (with statement numbers shown in the comments):

```
WHERE (mask1)           ! W1 *
  WHERE (mask2)         ! W2 *
  ...                   ! W3 *
  ELSEWHERE (mask3)    ! W4 *
  ...                   ! W5 *
  END WHERE             ! W6 *
ELSEWHERE (mask4)      ! W7 *
...                   ! W8 *
ELSEWHERE              ! W9
...                   ! W10
END WHERE              ! W11
```

**Note:** \* Fortran 95

The compiler sets control and pending control masks as it executes each statement, as shown below:

**Fortran 95**

```
Statement W1
  mc = mask1
  mp = .NOT. mask1
Statement W2
  mp = mask1 .AND. (.NOT. mask2)
  mc = mask1 .AND. mask2
Statement W4
  mc = mask1 .AND. (.NOT. mask2)
  mp = mask1 .AND. (.NOT. mask2)
  .AND. (.NOT. mask3)
  mc = mask1 .AND. (.NOT. mask2)
  .AND. mask3
Statement W6
  mc = mask1
  mp = .NOT. mask1
```

**End of Fortran 95**

```
Statement W7
  mc = .NOT. mask1
  mp = (.NOT. mask1) .AND. (.NOT.
mask4)
  mc = (.NOT. mask1) .AND. mask4
Statement W9
  mc = (.NOT. mask1) .AND. (.NOT.
mask4)
Statement W11
  mc = 0
  mp = 0
```

The compiler uses the values of the control masks set by statements *W2*, *W4*, *W7*, and *W9* when it executes the respective *where\_assignment\_statements* *W3*, *W5*, *W8*, and *W10*.

### Migration Tip:

Simplify logical evaluation of arrays

FORTRAN 77 source:

```
INTEGER A(10,10),B(10,10)
:
DO I=1,10
  DO J=1,10
    IF (A(I,J).LT.B(I,J)) A(I,J)=B(I,J)
  END DO
END DO
END
```

Fortran 90 or Fortran 95 source:

```
INTEGER A(10,10),B(10,10)
:
WHERE (A.LT.B) A=B
END
```

### Examples of the WHERE construct

```
REAL, DIMENSION(10) :: A,B,C,D
WHERE (A>0.0)
  A = LOG(A)           ! Only the positive elements of A
                      ! are used in the LOG calculation.
  B = A               ! The mask uses the original array A
                      ! instead of the new array A.
  C = A / SUM(LOG(A)) ! A is evaluated by LOG, but
                      ! the resulting array is an
                      ! argument to a non-elemental
                      ! function. All elements in A will
                      ! be used in evaluating SUM.
END WHERE

WHERE (D>0.0)
  C = CSHIFT(A, 1)    ! CSHIFT applies to all elements in array A,
                      ! and the array element values of D determine
                      ! which CSHIFT expression determines the
                      ! corresponding element values of C.
ELSEWHERE
  C = CSHIFT(A, 2)
END WHERE
END
```

### Fortran 95

The following example shows an array constructor in a **WHERE** construct statement and in a masked **ELSEWHERE** *mask\_expr*:

```
CALL SUB((/ 0, -4, 3, 6, 11, -2, 7, 14 /))

CONTAINS
  SUBROUTINE SUB(ARR)
    INTEGER ARR(:)
    INTEGER N

    N = SIZE(ARR)
```

```

! Data in array ARR at this point:
!
! A = | 0 -4 3 6 11 -2 7 14 |

WHERE (ARR < 0)
  ARR = 0
ELSEWHERE (ARR < ARR((/(N-I, I=0, N-1)/)))
  ARR = 2
END WHERE

! Data in array ARR at this point:
!
! A = | 2 0 3 2 11 0 7 14 |

END SUBROUTINE
END

```

The following example shows a nested **WHERE** construct statement and masked **ELSEWHERE** statement with a *where\_construct\_name*:

```

INTEGER :: A(10, 10), B(10, 10)
...
OUTERWHERE: WHERE (A < 10)
  INNERWHERE: WHERE (A < 0)
    B = 0
  ELSEWHERE (A < 5) INNERWHERE
    B = 5
  ELSEWHERE INNERWHERE
    B = 10
  END WHERE INNERWHERE
ELSEWHERE OUTERWHERE
  B = A
END WHERE OUTERWHERE
...

```

End of Fortran 95

## FORALL construct

Fortran 95

The **FORALL** construct performs assignment to groups of subobjects, especially array elements.

Unlike the **WHERE** construct, **FORALL** performs assignment to array elements, array sections, and substrings. Also, each assignment within a **FORALL** construct need not be conformable with the previous one. The **FORALL** construct can contain nested **FORALL** statements, **FORALL** constructs, **WHERE** statements, and **WHERE** constructs.

End of Fortran 95

**-qxf2003=autorealloc** does not apply to **FORALL** constructs. No reallocation of allocatable variables occurs during assignment statements inside a **FORALL** construct.

IBM Extension

The **INDEPENDENT** directive specifies that the left and right sides of the assignments inside a **FORALL** construct do not overlap.

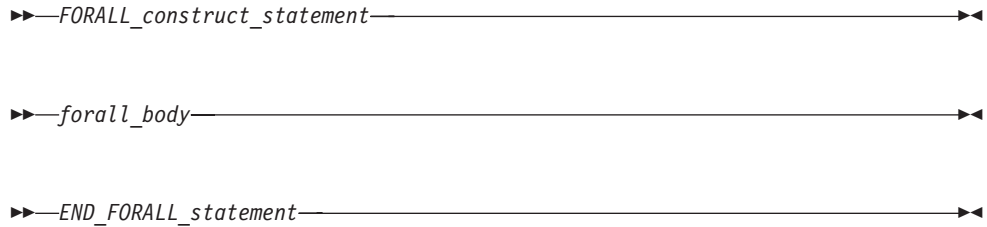

*FORALL\_construct\_statement*

See “FORALL (construct)” on page 358 for syntax details.

*END\_FORALL\_statement*

See “END (Construct)” on page 336 for syntax details.

*forall\_body*

is one or more of the following statements or constructs:

*forall\_assignment*

**WHERE** statement (see “WHERE” on page 478)

**WHERE** construct (see “WHERE construct” on page 113)

**FORALL** statement (see “FORALL” on page 355)

**FORALL** construct

*forall\_assignment*

is either *assignment\_statement* or *pointer\_assignment\_statement*

Any procedures that are referenced in a *forall\_body*, including one referenced by a defined operation, defined assignment, or finalization must be pure.

If a **FORALL** statement or construct is nested within a **FORALL** construct, the inner **FORALL** statement or construct cannot redefine any *index\_name* used in the outer **FORALL** construct.

Although no atomic object can be assigned to, or have its association status changed in the same statement more than once, different assignment statements within the same **FORALL** construct can redefine or reassociate an atomic object. Also, each **WHERE** statement and assignment statement within a **WHERE** construct must follow these restrictions.

If a *FORALL\_construct\_name* is specified, it must appear in both the **FORALL** statement and the **END FORALL** statement. Neither the **END FORALL** statement nor any statement within the **FORALL** construct can be a branch target statement.

## Interpreting the FORALL construct

### Fortran 95

1. From the **FORALL** Construct statement, evaluate the *subscript* and *stride* expressions for each *forall\_triplet\_spec* in any order. All possible pairings of *index\_name* values form the set of combinations. For example, given the statement:  
FORALL (I=1:3,J=4:5)  
The set of combinations of I and J is:  
 $\{(1,4), (1,5), (2,4), (2,5), (3,4), (3,5)\}$   
The **-1** and **-qnozerosize** compiler options do not affect this step.
2. Evaluate the *scalar\_mask\_expr* (from the **FORALL** Construct statement) for the set of combinations, in any order, producing a set of active combinations (those that evaluated to **.TRUE.**). For example, if the mask (I+J.NE.6) is applied to the above set, the set of active combinations is:  
 $\{(1,4), (2,5), (3,4), (3,5)\}$
3. Execute each *forall\_body* statement or construct in order of appearance. For the set of active combinations, each statement or construct is executed completely as follows:

#### *assignment\_statement*

Evaluate, in any order, all values in the right-hand side *expression* and all subscripts, strides, and substring bounds in the left-hand side *variable* for all active combinations of *index\_name* values.

Assign, in any order, the computed *expression* values to the corresponding *variable* entities for all active combinations of *index\_name* values. In a *forall\_assignment* if *variable* is allocatable, **-qxf2003=autorealloc** will not cause *variable* to be deallocated and/or allocated.

```
INTEGER, DIMENSION(50) :: A,B,C
INTEGER :: X,I=2,J=49
FORALL (X=I:J)
  A(X)=B(X)+C(X)
  C(X)=B(X)-A(X) ! All these assignments are performed after the
                  ! assignments in the preceding statement
END FORALL
END
```

#### *pointer\_assignment\_statement*

Determine, in any order, what will be the targets of the pointer assignment, and evaluate all subscripts, strides, and substring bounds in the pointer for all active combinations of *index\_name* values. If a target is not a pointer, determination of the target does not include evaluation of its value. Pointer assignment never *requires* the value of the righthand side to be determined.

Associate, in any order, all targets with the corresponding pointer entities for all active combinations of *index\_name* values.

#### **WHERE statement or construct**

Evaluate, in any order, the control mask and pending control mask for each **WHERE** statement, **WHERE** construct statement, **ELSEWHERE** statement, or masked **ELSEWHERE** statement each active combination of *index\_name* values, producing a refined set of active combinations for that statement, as described in "Interpreting masked array

assignments” on page 115. For each active combination, the compiler executes the assignment(s) of the **WHERE** statement, **WHERE** construct statement, or masked **ELSEWHERE** statement for those values of the control mask that are true for that active combination. The compiler executes each statement in a **WHERE** construct in order, as described previously.

```

INTEGER I(100,10), J(100), X
FORALL (X=1:100, J(X)>0)
  WHERE (I(X,*)<0)
    I(X,*)=0 ! Assigns 0 to an element of I along row X
              ! only if element value is less than 0 and value
              ! of element in corresponding column of J is
              ! greater than 0.
  ELSEWHERE
    I(X,*)=1
  END WHERE
END FORALL
END

```

### FORALL statement or construct

Evaluate, in any order, the *subscript* and *stride* expressions in the *forall\_triplet\_spec\_list* for the active combinations of the outer **FORALL** statement or construct. The valid combinations are the Cartesian product of combination sets of the inner and outer **FORALL** constructs. The *scalar\_mask\_expr* determines the active combinations for the inner **FORALL** construct. Statements and constructs for these active combinations are executed.

! Same as FORALL (I=1:100,J=1:100,I.NE.J) A(I,J)=A(J,I)

```

INTEGER A(100,100)
OUTER: FORALL (I=1:100)
  INNER: FORALL (J=1:100,I.NE.J)
    A(I,J)=A(J,I)
  END FORALL INNER
END FORALL OUTER
END

```

End of Fortran 95

## Data pointer assignment

Pointer assignment statement causes a pointer to become associated with a target or causes the pointer’s association status to become disassociated or undefined.

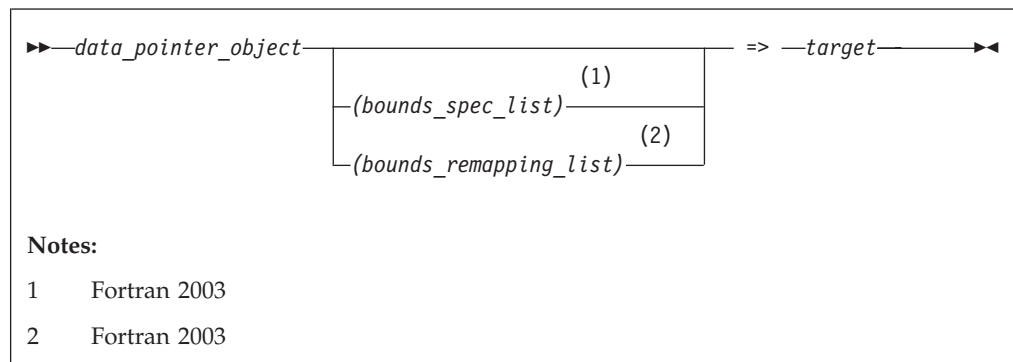

*target* is a variable or expression. If it is a variable, it must have the **TARGET**

attribute (or be a subobject of such an object) or the **POINTER** attribute. If it is an expression, it must yield a value that has the **POINTER** attribute.

If *target* is not unlimited polymorphic, it must have the same type parameters and rank as *data\_pointer\_object*, and *data\_pointer\_object* must be type-compatible with it. If *target* is unlimited polymorphic, *data\_pointer\_object* must be unlimited polymorphic, of sequence derived type, or of a type with the **BIND** attribute.

*data\_pointer\_object*  
must have the **POINTER** attribute.

Fortran 2003

*bounds\_spec*

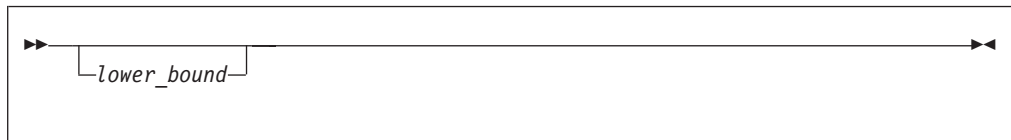

*lower\_bound*  
is a scalar integer expression.

End of Fortran 2003

Fortran 2003

*bounds\_remapping*

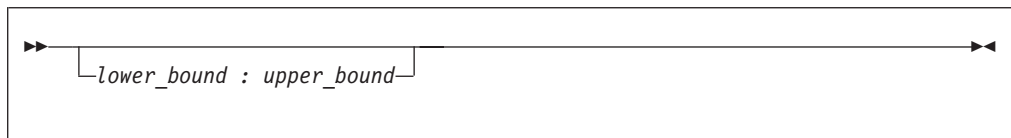

*lower\_bound*  
is a scalar integer expression.

*upper\_bound*  
is a scalar integer expression.

End of Fortran 2003

A target must not be an array section with a vector subscript, or a whole assumed-size array.

The size, bounds, and shape of the target of a disassociated array pointer are undefined. No part of such an array can be defined or referenced, although the array can be the argument of an intrinsic inquiry function that is inquiring about association status, argument presence, or a property of the type or type parameters.



### IBM Extension

A pointer of type `byte` can only be associated with a target of type `byte`, `INTEGER(1)`, or `LOGICAL(1)`.

End of IBM Extension

### Fortran 2003

If the *data\_pointer\_object* is not polymorphic and the *target* is polymorphic with dynamic type that differs from its declared type, the assignment target is the ancestor component of *target* that has the type of *data\_pointer\_object*. Otherwise, the assignment target is *target*.

If *data\_pointer\_object* is polymorphic, it assumes the dynamic type of *target*. If *data\_pointer\_object* is of sequence derived type or a type with the **BIND** attribute, the dynamic type of *target* must be that type.

If you specify *bounds\_spec\_list*, the number of bounds in the list must be equal to the rank of *data\_pointer\_object*.

If you specify either a *bounds\_spec\_list* or a *bounds\_remapping\_list*, you must not use a **SUBSCRIPTORDER** directive on the pointer

If you specify a *bounds\_remapping\_list*:

- The *target* must not be a disassociated or undefined pointer, and the size of the target must not be less than the size of the *data\_pointer\_object*.
- The number of *bounds\_re mappings* in the list must be equal to the rank of *data\_pointer\_object*.
- The lower bound of each dimension of the *data\_pointer\_object* becomes equal to the *lower\_bound* you specify in the corresponding *bounds\_remapping*.
- The upper bound of each dimension of the *data\_pointer\_object* becomes equal to the *upper\_bound* you specify in the corresponding *bounds\_remapping*.
- The extent of each dimension of the *data\_pointer\_object* is equal to the upper bound of that dimension, minus the lower bound of that dimension, plus 1.
- The elements of the target of *data\_pointer-object*, in array element order, are the first **SIZE** (*data-pointer-objec*) elements of the target, after any **SUBSCRIPTORDER** directives affect the target.

If you specify a *bounds\_spec\_list*:

- If you specify a *bounds\_spec\_list*, then the *lower\_bound* of each dimension of the *data\_pointer\_object* becomes equal to the *lower\_bound* in the corresponding *bounds\_spec*. The *lower\_bound* of each dimension is the result of the **LBOUND** intrinsic function that you apply to the corresponding dimension of the target.
- The extent of each dimension of the *data\_pointer\_object* is equal to the extent of the corresponding dimension of the target.
- The *upper\_bound* of each dimension of the *data\_pointer\_object* is equal to the *lower\_bound* of that dimension, plus the extent of that dimension, minus 1.

End of Fortran 2003

If neither *bounds\_remapping\_list* nor *bounds\_spec\_list* are specified:

During pointer assignment of an array pointer, the lower bound of each dimension is the result of the **LBOUND** intrinsic function applied to the corresponding dimension of the target. For an array section or array expression that is not a whole array or a structure component, the lower bound is 1. The upper bound of each dimension is the result of the **UBOUND** intrinsic function applied to the corresponding dimension of the target.

Any previous association between a *data\_pointer\_object* and a target is broken. If *target* is not a pointer, *data\_pointer\_object* becomes associated with *target*. If *target* is itself an associated pointer, *data\_pointer\_object* is associated with the target of *target*. If *target* is a pointer with an association status of disassociated or undefined, *data\_pointer\_object* acquires the same status. If *target* of a pointer assignment is an allocatable object, it must be allocated.

Pointer assignment for a pointer structure component can also occur via execution of a derived-type intrinsic assignment statement or a defined assignment statement.

**Related information:**

- See “ALLOCATE” on page 275 for an alternative form of associating a pointer with a target.

## Examples of pointer assignment

```

TYPE T
  INTEGER, POINTER :: COMP_PTR
ENDTYPE T
TYPE(T) T_VAR
INTEGER, POINTER :: P,Q,R
INTEGER, POINTER :: ARR(:)
BYTE, POINTER :: BYTE_PTR
LOGICAL(1), POINTER :: LOG_PTR
INTEGER, TARGET :: MYVAR
INTEGER, TARGET :: DARG(1:5)
P => MYVAR           ! P points to MYVAR
Q => P               ! Q points to MYVAR
NULLIFY (R)         ! R is disassociated
Q => R               ! Q is disassociated
T_VAR = T(P)        ! T_VAR%COMP_PTR points to MYVAR
ARR => DARG(1:3)
BYTE_PTR => LOG_PTR
END

```

---

## Procedure pointer assignment

**Fortran 2003**

The procedure pointer assignment statement causes a procedure pointer to become associated with a target or causes the procedure pointer’s association status to become disassociated or undefined.

▶▶—*proc\_pointer\_object*— => —*proc\_target*—▶▶

*proc\_target*

is an expression or a procedure name. If *proc\_target* is an expression, it must be a function that returns a procedure pointer. If *proc\_target* is a

procedure name, it must be the name of an external procedure, module procedure, dummy procedure, an intrinsic procedure that can be passed as an actual argument, or another procedure pointer. *proc\_target* must not be an elemental procedure.

*proc\_pointer\_object*  
is a procedure pointer.

If *proc\_target* is not a procedure pointer, *proc\_pointer\_object* becomes associated with *proc\_target*. If *proc\_target* is a procedure pointer and is associated with a procedure, *proc\_pointer\_object* becomes associated with the same procedure. If *proc\_target* is a pointer with an association status of disassociated or undefined, *proc\_pointer\_object* acquires the same status.

If the *proc\_pointer\_object* has an explicit interface, its characteristics must be the same as *proc\_target* except that *proc\_target* can be pure even if *proc\_pointer\_object* is not. If the characteristics of *proc\_pointer\_object* or *proc\_target* are such that an explicit interface is required, both *proc\_pointer\_object* and *proc\_target* must have an explicit interface.

If *proc\_pointer\_object* has an implicit interface and is explicitly typed or referenced as a function, *proc\_target* must be a function. If *proc\_pointer\_object* has an implicit interface and is referenced as a subroutine, *proc\_target* must be a subroutine.

If *proc\_target* and *proc\_pointer\_object* are functions, they must have the same type; corresponding type parameters must either be both deferred or have the same value.

If *proc\_target* is a specific procedure name that is also a generic name, only the specific procedure is associated with *proc\_pointer\_object*.

**Related information:**

- “PROCEDURE declaration” on page 419

---

End of Fortran 2003

---

## Integer pointer assignment

---

### IBM Extension

---

Integer pointer variables can be:

- Used in integer expressions
- Assigned values as absolute addresses
- Assigned the address of a variable using the **LOC** intrinsic function. (Objects of derived type and structure components must be of sequence-derived type when used with the **LOC** intrinsic function.)

**Note:** The XL Fortran compiler does not use the size of an object as a multiplier in an arithmetic expression where an integer pointer is an operand.

## Example of integer pointer assignment

```
INTEGER INT_TEMPLATE  
POINTER (P,INT_TEMPLATE)  
INTEGER MY_ARRAY(10)
```

```

DATA MY_ARRAY/1,2,3,4,5,6,7,8,9,10/
INTEGER, PARAMETER :: WORDSIZE=4

P = LOC(MY_ARRAY)
PRINT *, INT_TEMPLATE           ! Prints '1'
P = P + 4;                      ! Add 4 to reach next element
                                !   because arithmetic is byte-based
PRINT *, INT_TEMPLATE          ! Prints '2'

P = LOC(MY_ARRAY)
DO I = 1,10
  PRINT *,INT_TEMPLATE
  P = P + WORDSIZE             ! Parameterized arithmetic is suggested
END DO
END

```

End of IBM Extension

---

## Chapter 7. Execution Control

You can control the execution of a program sequence using constructs. Constructs contain statement blocks and other executable statements that can alter the normal execution sequence. This section contains detailed descriptions of the following constructs:

- **F2003** ASSOCIATE **F2003**
- DO
- DO WHILE
- IF
- SELECT CASE
- **F2003** SELECT TYPE **F2003**

Detailed syntax diagrams for the constructs in this section can be found by following the links to the associated statements.

For nesting to occur, a construct must be wholly contained within another construct. If a statement specifies a construct name, it applies to that construct. If the statement does not specify a construct name, the statement applies to the innermost construct in which it appears.

In addition to constructs, XL Fortran provides branching as a method for transferring control from one statement to another statement in the same scoping unit.

---

### Statement blocks

A *statement block* consists of a sequence of zero or more executable statements, executable constructs, **FORMAT** statements, or **DATA** statements embedded in another executable construct and are treated as a single unit.

In the same program, you can not transfer control from outside of the statement block to within the statement block. You can transfer control within the statement block, or from within the statement block to outside the block. For example, you can have a **GO TO** statement branching to a label that is within a statement block. You cannot branch into a statement block from a **GO TO** statement outside the statement block.

---

### ASSOCIATE Construct

#### Fortran 2003

The **ASSOCIATE** construct creates an association between an identifier and a variable, or the value of an expression, during the execution of that construct. The identifier you specify in an **ASSOCIATE** construct becomes an associating entity. You can create multiple associating entities inside a single **ASSOCIATE** construct.

## Syntax

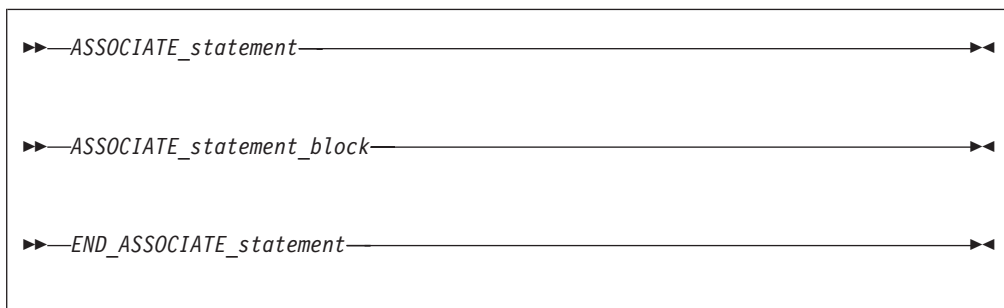

*ASSOCIATE\_statement*

See “ASSOCIATE” on page 279 for syntax details

*END\_ASSOCIATE\_statement*

See “END (Construct)” on page 336 for syntax details

Execution of an **ASSOCIATE** construct causes execution of an *ASSOCIATE\_statement* followed by the *ASSOCIATE\_statement\_block*. During execution of that block, the construct creates an association with an identifier and the corresponding selector. The associating entity assumes the declared type and type parameters of the selector. The name of the associating entity is an *associate name*. For further information on associate names, see “Associate names” on page 142.

## Examples

The following example uses the **ASSOCIATE** construct as a shorthand for a complex expression and renames an existing variable, *MYREAL*. After the end of the **ASSOCIATE** construct, any change within the construct to the value of the associating entity that associates with *MYREAL* is reflected.

```
PROGRAM ASSOCIATE_EXAMPLE

  REAL :: MYREAL, X, Y, THETA, A
  X = 0.42
  Y = 0.35
  MYREAL = 9.1
  THETA = 1.5
  A = 0.4

  ASSOCIATE ( Z => EXP(-(X**2+Y**2)) * COS(THETA), V => MYREAL)
    PRINT *, A+Z, A-Z, V
    V = V * 4.6
  END ASSOCIATE

  PRINT *, MYREAL

END PROGRAM ASSOCIATE_EXAMPLE
```

The expected output is.

```
0.4524610937 0.3475389183 9.100000381
41.86000061
```

End of Fortran 2003

---

## DO construct

The **DO** construct specifies the repeated execution of a statement block. Such a repeated block is called a *loop*.

The iteration count of a loop can be determined at the beginning of execution of the **DO** construct, unless it is infinite.

You can curtail a specific iteration with the **CYCLE** statement, and the **EXIT** statement terminates the loop.

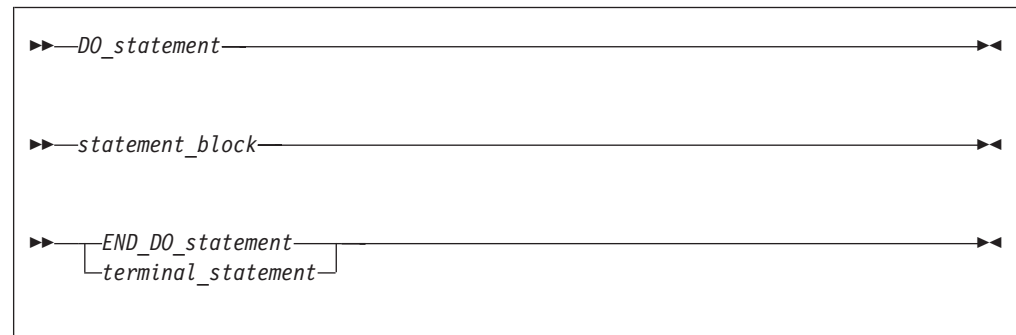

*DO\_statement* See “DO” on page 323 for syntax details

*END\_DO\_statement*

See “END (Construct)” on page 336 for syntax details

*terminal\_statement*

is a statement that terminates the **DO** construct. See the description below.

If you specify a **DO** construct name on the **DO** statement, you must terminate the construct with an **END DO** statement with the same construct name. Conversely, if you do not specify a **DO** construct name on the **DO** statement, and you terminate the **DO** construct with an **END DO** statement, you must not have a **DO** construct name on the **END DO** statement.

### The terminal statement

The terminal statement must follow the **DO** statement and must be executable. See Chapter 11, “Statements and attributes,” on page 269 for a listing of statements that can be used as the terminal statement. If the terminal statement of a **DO** construct is a logical **IF** statement, it can contain any executable statement compatible with the restrictions on a logical **IF** statement.

If you specify a statement label in the **DO** statement, you must terminate the **DO** construct with a statement that is labeled with that statement label.

A labeled **DO** statement must be terminated with an **END DO** statement that has a matching statement label. A **DO** statement with no label must be terminated with an unlabeled **END DO** statement.

Nested, labeled **DO** and **DO WHILE** constructs can share the same terminal statement if the terminal statement is labeled, and if it is not an **END DO** statement.

## Range of a DO construct

The range of a **DO** construct consists of all the executable statements following the **DO** statement, up to and including the terminal statement. In addition to the rules governing the range of constructs, you can only transfer control to a shared terminal statement from the innermost sharing **DO** construct.

## Active and inactive DO constructs

A **DO** construct is either active or inactive. Initially inactive, a **DO** construct becomes active only when its **DO** statement is executed. Once active, the **DO** construct becomes inactive only when:

- Its iteration count becomes zero.
- A **RETURN** statement occurs within the range of the **DO** construct.
- Control is transferred to a statement outside the range of the **DO** construct.
- A subroutine invoked from within the **DO** construct returns, through an alternate return specifier, to a statement that is outside the range of the **DO** construct.
- An **EXIT** statement that belongs to the **DO** construct executes.
- An **EXIT** statement or a **CYCLE** statement that is within the range of the **DO** construct, but belongs to an outer **DO** or **DO WHILE** construct, executes.
- A **STOP** statement executes or the program stops for any other reason.

When a **DO** construct becomes inactive, the **DO** variable retains the last value assigned to it.

## Executing a DO statement

An infinite **DO** does not have an iteration count limit or a termination condition.

If the loop is not an infinite **DO**, the **DO** statement includes an initial parameter, a terminal parameter, and an optional increment.

1. The initial parameter,  $m_1$ , the terminal parameter,  $m_2$ , and the increment,  $m_3$ , are established by evaluating the **DO** statement expressions ( $a\_expr1$ ,  $a\_expr2$ , and  $a\_expr3$ , respectively). Evaluation includes, if necessary, conversion to the type of the **DO** variable according to the rules for arithmetic conversion. (See "Arithmetic conversion" on page 112.) If you do not specify  $a\_expr3$ ,  $m_3$  has a value of 1.  $m_3$  must not have a value of zero.
2. The **DO** variable becomes defined with the value of the initial parameter ( $m_1$ ).
3. The iteration count is established, determined by the expression:

$$\text{MAX} (\text{INT} ( (m_2 - m_1 + m_3) / m_3 ), 0)$$

Note that the iteration count is 0 whenever:

$$m_1 > m_2 \text{ and } m_3 > 0, \text{ or}$$

$$m_1 < m_2 \text{ and } m_3 < 0$$

The iteration count cannot be calculated if the **DO** variable is missing. This is referred to as an infinite **DO** construct.

### IBM Extension

The iteration count cannot exceed  $2^{*}31 - 1$  for integer variables of kind 1, 2, or 4, and cannot exceed  $2^{*}63 - 1$  for integer variables of kind 8. The count becomes undefined if an overflow or underflow situation arises during the calculation.

### End of IBM Extension



At the completion of the **DO** statement, loop control processing begins.

### **Loop control processing**

Loop control processing determines if further execution of the range of the **DO** construct is required. The iteration count is tested. If the count is not zero, the first statement in the range of the **DO** construct begins execution. If the iteration count is zero, the **DO** construct becomes inactive. If, as a result, all of the **DO** constructs sharing the terminal statement of this **DO** construct are inactive, normal execution continues with the execution of the next executable statement following the terminal statement. However, if some of the **DO** constructs sharing the terminal statement are active, execution continues with incrementation processing of the innermost active **DO** construct.

### **DO execution range**

The range of a **DO** construct includes all statements within the statement block. These statements execute until reaching the terminal statement. A **DO** variable must not become redefined or undefined during execution of the range of a **DO** construct, and only becomes redefined through incremental processing.

### **Terminal statement execution**

Execution of the terminal statement occurs as a result of the normal execution sequence, or as a result of transfer of control, subject to the restriction that you cannot transfer control into the range of a **DO** construct from outside the range. Unless execution of the terminal statement results in a transfer of control, execution continues with incrementation processing.

### **Incrementation processing**

1. The **DO** variable, the iteration count, and the increment of the active **DO** construct whose **DO** statement was most recently executed, are selected for processing.
2. The value of the **DO** variable is increased by the value of  $m_3$ .
3. The iteration count is decreased by 1.
4. Execution continues with loop control processing of the same **DO** construct whose iteration count was decremented.

**Migration Tip:**

- Use **EXIT**, **CYCLE**, and infinite **DO** statements instead of a **GOTO** statement.

## FORTRAN 77 source

```
      I = 0
      J = 0
20    CONTINUE
      I = I + 1
      J = J + 1
      PRINT *, I
      IF (I.GT.4) GOTO 10    ! Exiting loop
      IF (J.GT.3) GOTO 20    ! Iterate loop immediately
      I = I + 2
      GOTO 20
10    CONTINUE
      END
```

## Fortran 90/95/2003 source:

```
      I = 0 ; J = 0
      DO
      I = I + 1
      J = J + 1
      PRINT *, I
      IF (I.GT.4) EXIT
      IF (J.GT.3) CYCLE
      I = I + 2
      END DO
      END
```

### Examples:

```
INTEGER :: SUM=0
OUTER: DO
  INNER: DO
    READ (5,*) J
    IF (J.LE.I) THEN
      PRINT *, 'VALUE MUST BE GREATER THAN ', I
      CYCLE INNER
    END IF
    SUM=SUM+J
    IF (SUM.GT.500) EXIT OUTER
    IF (SUM.GT.100) EXIT INNER
  END DO INNER
  SUM=SUM+I
  I=I+10
END DO OUTER
PRINT *, 'SUM =',SUM
END
```

---

## DO WHILE construct

The **DO WHILE** construct specifies the repeated execution of a statement block for as long as the scalar logical expression specified in the **DO WHILE** statement is true. You can curtail a specific iteration with the **CYCLE** statement, and the **EXIT** statement terminates the loop.

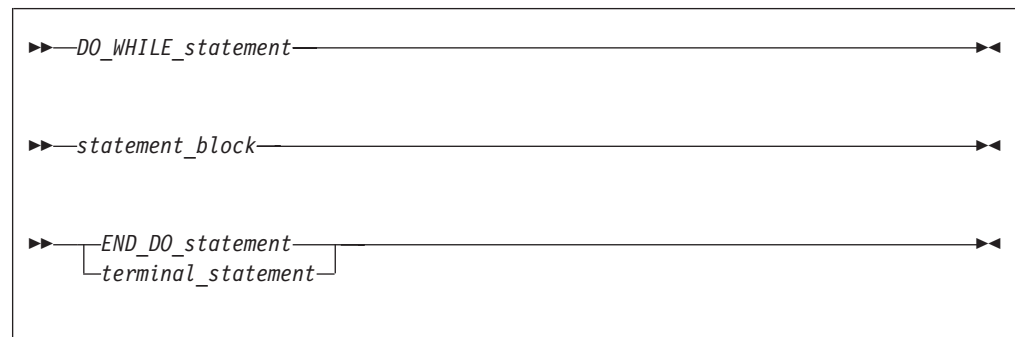

*DO WHILE\_statement*

See “DO WHILE” on page 325 for syntax details

*END\_DO\_statement*

See “END (Construct)” on page 336 for syntax details

*terminal\_stmt* is a statement that terminates the **DO WHILE** construct. See “The terminal statement” on page 131 for details.

The rules applicable to the **DO** construct names and ranges, active and inactive **DO** constructs, and terminal statements also apply to the **DO WHILE** construct.

### Example

```
I=10
TWO_DIGIT: DO WHILE ((I.GE.10).AND.(I.LE.99))
  J=J+I
  READ (5,*) I
END DO TWO_DIGIT
END
```

## IF construct

The **IF** construct selects no more than one of its statement blocks for execution.

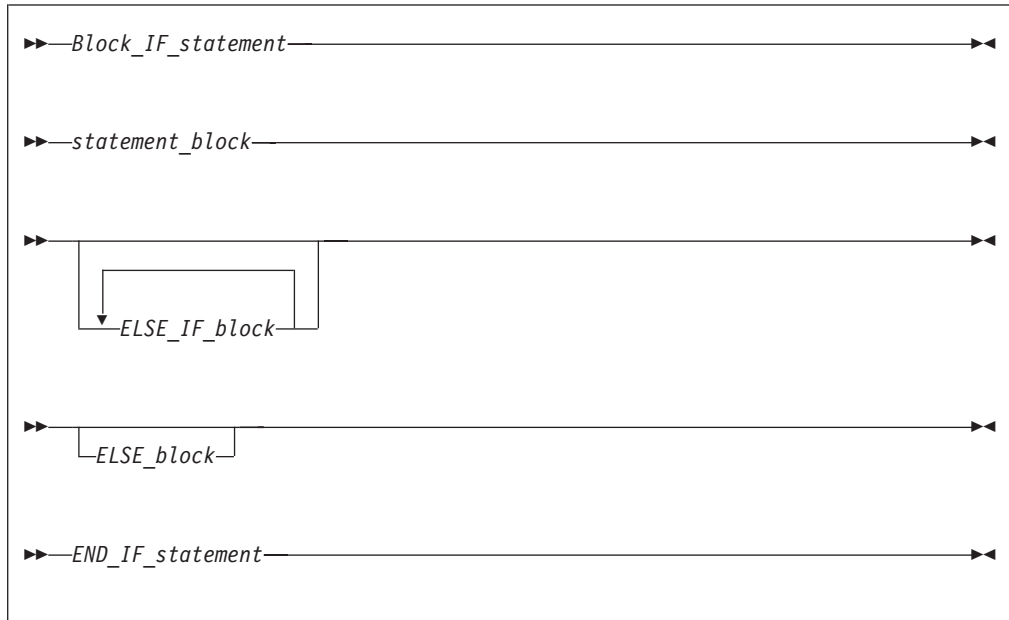

*Block\_IF\_statement*

See “IF (block)” on page 369 for syntax details.

*END\_IF\_statement*

See “END (Construct)” on page 336 for syntax details.

*ELSE\_IF\_block*

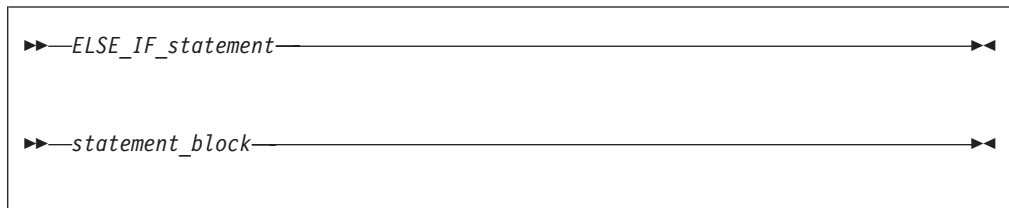

*ELSE\_IF\_statement*

See “ELSE IF” on page 333 for syntax details.

*ELSE\_block*

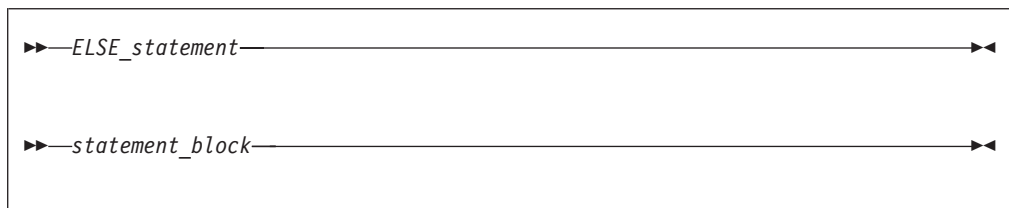

*ELSE\_statement*

See “ELSE” on page 332 for syntax details.

The scalar logical expressions in an **IF** construct (that is, the block **IF** and **ELSE IF** statements) are evaluated in the order of their appearance until a true value, an **ELSE** statement, or an **END IF** statement is found:

- If a true value or an **ELSE** statement is found, the statement block immediately following executes, and the **IF** construct is complete. The scalar logical expressions in any remaining **ELSE IF** statements or **ELSE** statements of the **IF** construct are not evaluated.
- If an **END IF** statement is found, no statement blocks execute, and the **IF** construct is complete.

If the **IF** construct name is specified, it must appear on the **IF** statement and **END IF** statement, and optionally on any **ELSE IF** or **ELSE** statements.

## Example

```
! Get a record (containing a command) from the terminal

DO
  WHICHC: IF (CMD .EQ. 'RETRY') THEN           ! named IF construct
    IF (LIMIT .GT. FIVE) THEN                 ! nested IF construct
!      Print retry limit exceeded
      CALL STOP
    ELSE
      CALL RETRY
    END IF
  ELSE IF (CMD .EQ. 'STOP') THEN WHICHC       ! ELSE IF blocks
    CALL STOP
  ELSE IF (CMD .EQ. 'ABORT') THEN
    CALL ABORT
  ELSE WHICHC                                 ! ELSE block
!      Print unrecognized command
  END IF WHICHC
END DO
END
```

---

## SELECT CASE construct

The **CASE** construct has a concise syntax for selecting, at most, one of a number of statement blocks for execution. The case selector of each **CASE** statement is compared to the expression of the **SELECT CASE** statement.

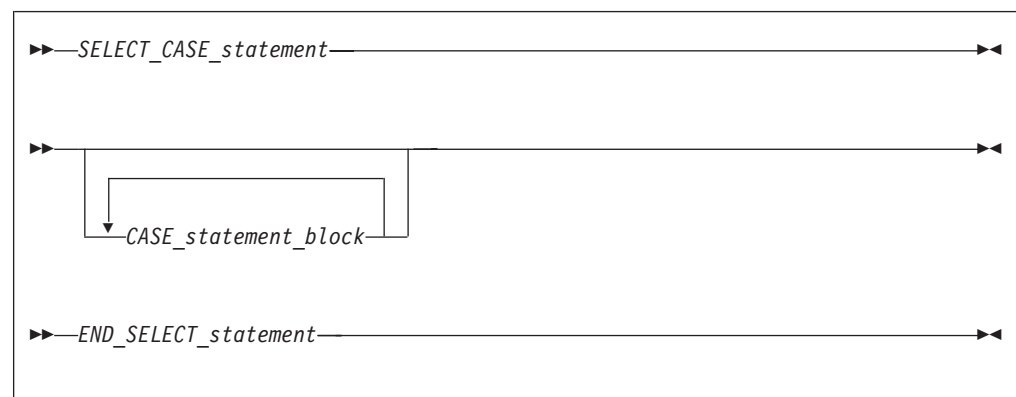

*SELECT\_CASE\_statement*

defines the case expression that is to be evaluated. See “SELECT CASE” on page 446 for syntax details.

*END\_SELECT\_statement*

terminates the **CASE** construct. See “END (Construct)” on page 336 for syntax details.

*CASE\_statement\_block*

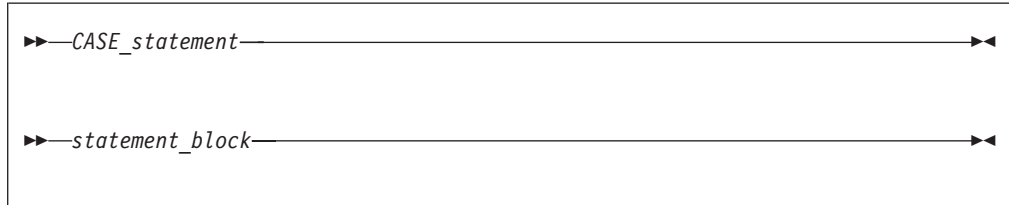

*CASE\_statement*

defines the case selector, which is a value, set of values, or default case, for which the subsequent statement block is executed. See “CASE” on page 292 for syntax details.

In the construct, each case value must be of the same type as the case expression.

The **CASE** construct executes as follows:

1. The case expression is evaluated. The resulting value is the case index.
2. The case index is compared to the *case\_selector* of each **CASE** statement.
3. If a match occurs, the statement block associated with that **CASE** statement is executed. No statement block is executed if no match occurs. (See “CASE” on page 292.)
4. Execution of the construct is complete and control is transferred to the statement after the **END SELECT** statement.

A **CASE** construct contains zero or more **CASE** statements that can each specify a value range, although the value ranges specified by the **CASE** statements cannot overlap.

A default *case\_selector* can be specified by one of the **CASE** statements. A default *CASE\_statement\_block* can appear anywhere in the **CASE** construct; it can appear at the beginning or end, or among the other blocks.

If a construct name is specified, it must appear on the **SELECT CASE** statement and **END SELECT** statement, and optionally on any **CASE** statements.

You can only branch to the **END SELECT** statement from within the **CASE** construct. A **CASE** statement cannot be a branch target.

**Migration Tip:**

Use **CASE** in place of block **IFs**.

FORTRAN 77 source

```
IF (I .EQ. 3) THEN
  CALL SUBA()
ELSE IF (I.EQ. 5) THEN
  CALL SUBB()
ELSE IF (I .EQ. 6) THEN
  CALL SUBC()
ELSE
  CALL OTHERSUB()
ENDIF
END
```

Fortran 90/95/2003 source:

```
SELECTCASE(I)
CASE(3)
  CALL SUBA()
CASE(5)
  CALL SUBB()
CASE(6)
  CALL SUBC()
CASE DEFAULT
  CALL OTHERSUB()
END SELECT
END
```

## Examples

```
ZERO: SELECT CASE(N)

CASE DEFAULT ZERO
  OTHER: SELECT CASE(N) ! start of CASE construct OTHER
    CASE(:-1)
      SIGNUM = -1      ! this statement executed when n≤-1
    CASE(1:) OTHER
      SIGNUM = 1
  END SELECT OTHER    ! end of CASE construct OTHER
CASE (0)
  SIGNUM = 0

END SELECT ZERO
END
```

---

## SELECT TYPE construct

---

### Fortran 2003

The **SELECT TYPE** construct selects, at most, one of its constituent blocks for execution. The selection is based on the dynamic type of an expression. A name is associated with the expression, in the same way as for the **ASSOCIATE** construct.

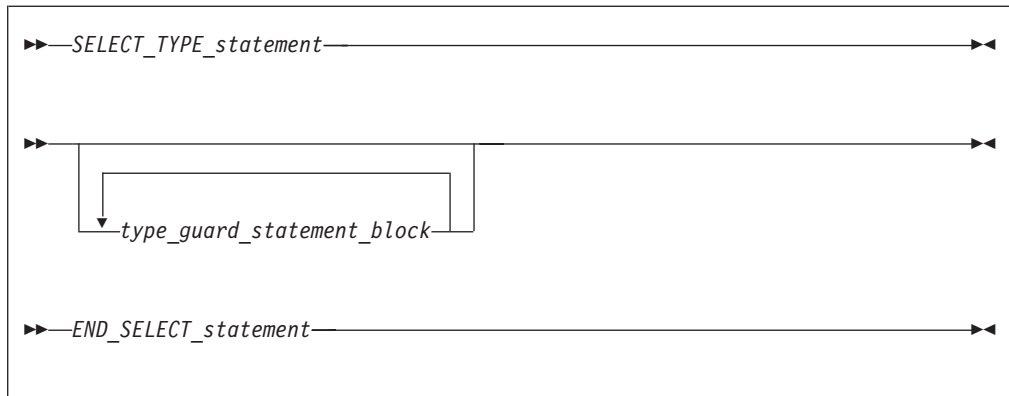

*SELECT\_TYPE\_statement*

defines the selector expression that is to be evaluated and optionally associates a name (an associate name) with the selector expression. If you do not specify an associate name in the *SELECT\_TYPE\_statement*, the selector expression must be a named variable. The name of this variable becomes the associate name. Execution of a **SELECT TYPE** construct whose selector is not a variable causes the selector expression to be evaluated. See “SELECT TYPE” on page 447 for syntax details.

*type\_guard\_statement\_block*

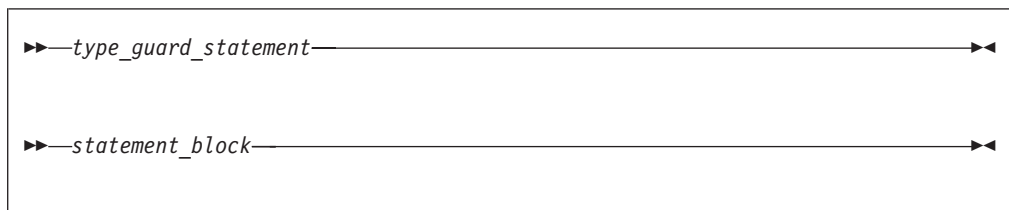

*type\_guard\_statement*

The dynamic type of the selector expression is compared to the type specified in the *type\_guard\_statement*. If the rules for type comparison succeed for a particular *type\_guard\_statement* the subsequent statement block is executed. A type guard statement cannot be a branch target statement. It is permissible to branch to an *end-select-type-stmt* only from within its **SELECT TYPE** construct. See “Type Guard” on page 467 for syntax details. The other attributes of the associating entity are described in “Associate names” on page 142.

*END\_SELECT\_statement*

terminates the **SELECT TYPE** construct. See “END (Construct)” on page 336 for syntax details.

The block to be executed is selected as follows:

1. If a **TYPE IS** type guard statement matches the selector, the block following that statement is executed. A **TYPE IS** type guard statement matches the selector if the dynamic type and kind type parameter values of the selector are the same as those specified by the statement.
2. Otherwise, if exactly one **CLASS IS** type guard statement matches the selector, the block following that statement is executed. A **CLASS IS** type guard statement matches the selector if the dynamic type of the selector is an extension of the type specified by the statement, and the kind type parameter



values specified by the statement are the same as the corresponding type parameter values of the dynamic type of the selector.

3. Otherwise, if several **CLASS IS** type guard statements match the selector, one of these statements must specify a type that is an extension of all the types specified in the others; the block following that statement is executed.
4. Otherwise, if there is a **CLASS DEFAULT** type guard statement, the block following that statement is executed.

Within the block following a **TYPE IS** type guard statement, the associating entity is not polymorphic, has the type named in the type guard statement, and has the type parameters of the selector.

Within the block following a **CLASS IS** type guard statement, the associating entity is polymorphic and has the declared type named in the type guard statement. The type parameters of the associating entity are those of the type specified in the **CLASS IS** type guard statement.

Within the block following a **CLASS DEFAULT** type guard statement, the associating entity is polymorphic and has the same declared type as the selector. The type parameters of the associating entity are those of the declared type of the selector.

## Examples

```
TYPE :: POINT
  REAL :: X, Y
END TYPE POINT

TYPE, EXTENDS(POINT) :: POINT_3D
  REAL :: Z
END TYPE POINT_3D

TYPE, EXTENDS(POINT) :: COLOR_POINT
  INTEGER :: COLOR
END TYPE COLOR_POINT

TYPE(POINT), TARGET :: P
TYPE(POINT_3D), TARGET :: P3
TYPE(COLOR_POINT), TARGET :: C
CLASS(POINT), POINTER :: P_OR_C

P_OR_C => C
SELECT TYPE ( A => P_OR_C )
  CLASS IS ( POINT )
    ! "CLASS ( POINT ) :: A" implied here
    PRINT *, A%X, A%Y ! This block gets executed
  TYPE IS ( POINT_3D )
    ! "TYPE ( POINT_3D ) :: A" implied here
    PRINT *, A%X, A%Y, A%Z
END SELECT
```

End of Fortran 2003

---

## Associate names

Within a **SELECT TYPE** or **ASSOCIATE** construct, each associating entity has the same rank as its associated selector. The lower bound of each dimension is the result of the intrinsic function **LBOUND** applied to the corresponding dimension of selector. The upper bound of each dimension is one less than the sum of the lower bound and the extent.

The associating entity has the **ASYNCHRONOUS**, **INTENT**, or **VOLATILE** attribute if the selector is a variable with the same attribute. The associating entity has the **TARGET** attribute if the selector has the **TARGET** or **POINTER** attribute. If the associating entity is polymorphic, it assumes the dynamic type and type parameter values of the selector. If the selector has the **OPTIONAL** attribute, then it must be present.

If the selector is not permitted to appear in a variable definition context or is an array with a vector subscript, the associate name must not appear in a variable definition context.

---

## Branching

You can also alter the normal execution sequence by branching. A branch transfers control from one statement to a labeled branch target statement in the same scoping unit. A branch target statement can be any executable statement except a **CASE**, **ELSE**, **ELSE IF**, or **TYPE GUARD** statement.

The following statements can be used for branching:

- Assigned **GO TO**  
transfers program control to an executable statement, whose statement label is designated in an **ASSIGN** statement. See “GO TO (assigned)” on page 365 for syntax details.
- Computed **GO TO**  
transfers control to possibly one of several executable statements. See “GO TO (computed)” on page 366 for syntax details.
- Unconditional **GO TO**  
transfers control to a specified executable statement. See “GO TO (unconditional)” on page 367 for syntax details.
- Arithmetic **IF**  
transfers control to one of three executable statements, depending on the evaluation of an arithmetic expression. See “IF (arithmetic)” on page 368 for syntax details.

The following input/output specifiers can also be used for branching:

- the **END=** end-of-file specifier  
transfers control to a specified executable statement if an endfile record is encountered (and no error occurs) in a **READ** statement.
- the **ERR=** error specifier  
transfers control to a specified executable statement in the case of an error. You can specify this specifier in the **BACKSPACE**, **ENDFILE**, **REWIND**, **CLOSE**, **OPEN**, **READ**, **WRITE**, and **INQUIRE** statements.
- the **EOR=** end-of-record specifier





transfers control to a specified executable statement if an end-of-record condition is encountered (and no error occurs) in a **READ** statement.



---

## Chapter 8. Program units and procedures

This section describes:



- “Scope”
- “Association” on page 150
- “Program units, procedures, and subprograms” on page 154
- “Interface blocks” on page 158
- “Generic interface blocks” on page 161
- “Abstract interface” on page 169
- “Main program” on page 170
- “Modules” on page 171
- “Block data program unit” on page 174
- “Function and subroutine subprograms” on page 175
- “Intrinsic procedures” on page 179
- “Arguments” on page 180
- “Argument association” on page 183
- “Recursion” on page 195
-  “Pure procedures” on page 196 
-  “Elemental Procedures” on page 198 

---

### Scope

A program unit consists of a set of nonoverlapping scoping units. A *scoping unit* is that portion of a program unit that has its own scope boundaries. It is one of the following:

- A derived-type definition
- A procedure interface body (not including any derived-type definitions and interface bodies within it)
- A program unit, module subprogram, or internal subprogram (not including derived-type definitions, interface bodies, module subprograms, and internal subprograms).

A host scoping unit is the scoping unit that immediately surrounds another scoping unit. For example, in the following diagram, the host scoping unit of the internal function C is the scoping unit of the main program A. Host association is the method by which an internal subprogram, module subprogram, or derived-type definition accesses names from its host.  Using the **IMPORT** statement, an interface body can also access names from its host. 

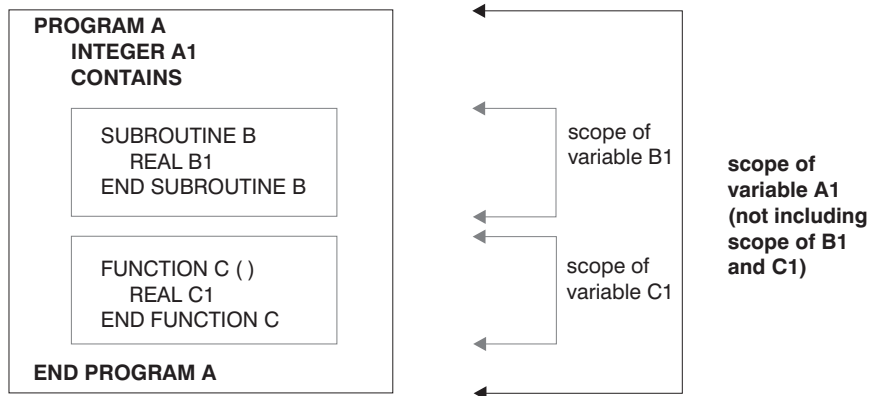

Entities that have scope are:

- A name (see below)
- A label (local entity)
- An external input/output unit number (global entity)
- An operator symbol. Intrinsic operators are global entities, while defined operators are local entities.
- An assignment symbol (global entity)

If the scope is an executable program, the entity is called a *global entity*. If the scope is a scoping unit, the entity is called a *local entity*. If the scope is a statement or part of a statement, the entity is called a *statement entity*. F95 If the scope is a construct, the entity is called a *construct entity*. F95

## The scope of a name

### Global entity

Global entities are:

- Program units
- External procedures
- Common blocks
- IBM **CRITICAL** *lock\_names* IBM
- F2003 Entities that have binding labels. F2003

If a name identifies a global entity, F2003 it cannot be the same as any binding label in the same executable program, F2003 and it cannot be used to identify any other global entity in the same executable program unless that entity is an intrinsic module.

See Conventions for XL Fortran external names in the *XL Fortran Optimization and Programming Guide* for details on restrictions on names of global entities.

### Local entity

Entities of the following classes are local entities of the scoping unit in which they are defined:

1. Named variables that are not statement entities, module procedures, named constants, derived-type definitions, construct names, generic identifiers, statement functions, internal subprograms, dummy procedures, intrinsic procedures, or namelist group names.

2. Components and bindings of a derived type definition where each derived type definition has its own class.

A component name has the same scope as the type of which it is a component. You can specify a name within a component designator of a structure of that type, or as a component keyword in a structure constructor for that type.

A binding name of a procedure has the same scope as the type. It can appear only as the binding-name in a procedure reference. A generic binding for which the generic-spec is not a generic-name has a scope that consists of all scoping units in which an entity of that type is accessible

If the derived type is defined in a module and contains the **PRIVATE** statement, the type and its components are accessible in any of the defining module's subprograms by host association. If the accessing scoping unit accesses this type by use association, that scoping unit, and any scoping unit that accesses the entities of that scoping unit by host association can access the derived-type definition, and only those components with the **PUBLIC** attribute.

3. Argument keywords (in a separate class for each procedure with an explicit interface).

A dummy argument name in an internal procedure, module procedure, or procedure interface block has a scope as an argument keyword of the scoping unit of its host. As an argument keyword, it may appear only in a procedure reference for the procedure of which it is a dummy argument. If the procedure or procedure interface block is accessible in another scoping unit by use association or host association, the argument keyword is accessible for procedure references for that procedure in that scoping unit.

In a scoping unit, a name that identifies a local entity of one class may be used to identify a local entity of another class. Such a name must not be used to identify another local entity of the same class, except in the case of generic names. A name that identifies a global entity in a scoping unit cannot be used to identify a local entity of Class 1 in that scoping unit, except for a common block name or the name of an external function. Components and bindings of a record structure are local entities of class 2. A separate class exists for each type.

---

#### IBM Extension

---

A name declared to be a derived type can have the same name as another local entity of class 1 of that scoping unit that is not a derived-type. In this case, the structure constructor for that type is not available in that scope. Similarly, a local entity of class 1 is accessible through host association or use association, even if there is another local entity of class 1 accessible in that scope, if:

- one of the two entities is a derived type and the other is not; and
- in the case of host association, the derived type is accessible via host association. For example, given a module M, a program unit P, and an internal subprogram or module subprogram S nested in P, if you have an entity named T1 declared in M that is accessed by use association in P (or in S), you can declare another entity in P (or in S, respectively) with the same name T1, so long as one of the two is a derived type. If you have an entity named T2 accessible in P, and an entity named T2 declared in S, then the T2 accessible in P is accessible in S if the T2 in P is a derived type. If the T2 in P was not a derived type, it would not be accessible in S if S declared another T2 (of derived type or not).

The structure constructor for that type will not be available in that scope. A local entity of class 1 in a scope that has the same name as a derived type accessible in

that scope must be explicitly declared in a declaration statement in that scope.

End of IBM Extension

If two local entities of class 1, one of which is a derived type, are accessible in a scoping unit, any **PUBLIC** or **PRIVATE** statement that specifies the name of the entities applies to both entities. If the name of the entities is specified in a **VOLATILE** statement, the entity or entities declared in that scope have the volatile attribute. If the two entities are public entities of a module, any rename on a **USE** statement that references the module and specifies the names of the entities as the *use\_name* applies to both entities.

A common block name in a scoping unit can be the name of any local entity other than a named constant or intrinsic procedure. The name is recognized as the common block entity only when the name is delimited by slashes in a **BIND**, **COMMON**, **VOLATILE**, or **SAVE** statement. If it is not, the name identifies the local entity. An intrinsic procedure name can be the name of a common block in a scoping unit that does not reference the intrinsic procedure. In this case, the intrinsic procedure name is not accessible.

An external function name can also be the function result name. This is the only way that an external function name can also be a local entity.

If a scoping unit contains a local entity of Class 1 with the same name as an intrinsic procedure, the intrinsic procedure is not accessible in that scoping unit.

An interface block generic name can be the same as any of the procedure names in the interface block, or the same as any accessible generic name. It can be the same as any generic intrinsic procedure. See "Resolution of procedure references" on page 193 for details.

## Statement and construct entities

**Statement entities:** The following items are statement entities:

- Name of a statement function dummy argument.  
SCOPE: Scope of the statement in which it appears.
- Name of a variable that appears as the **DO** variable of an implied-**DO** in a **DATA** statement or array constructor.  
SCOPE: Scope of the implied-**DO** list.

Except for a common block name or scalar variable name, the name of a global entity or local entity of class 1 that is accessible in the scoping unit of a statement or construct must not be the name of a statement or construct entity of that statement or construct. Within the scope of a statement or construct entity, another statement or construct entity must not have the same name.

The name of a variable that appears as a dummy argument in a statement function statement has a scope of the statement in which it appears. It has the type and type parameters that it would have if it were the name of a variable in the scoping unit that includes the statement function.

If the name of a global or local entity accessible in the scoping unit of a statement or construct is the same as the name of a statement or construct entity in that statement or construct, the name is interpreted within the scope of the statement or construct entity as that of the statement or construct entity. Elsewhere in the



scoping unit, including parts of the statement or construct outside the scope of the statement or construct entity, the name is interpreted as that of the global or local entity.

If a statement or construct entity has the same name as an accessible name that denotes a variable, constant, or function, the statement or construct entity has the same type and type parameters as the variable, constant or function. Otherwise, the type of the statement or construct entity is determined through the implicit typing rules in effect. If the statement entity is the **DO** variable of an implied-**DO** in a **DATA** statement, the variable cannot have the same name as an accessible named constant.

#### Statement and construct entity:

---

#### Fortran 95

---

The following is a statement and/or construct entity:

- Name of a variable that appears as an *index\_name* in a **FORALL** statement or **FORALL** construct.
  - SCOPE: Scope of the **FORALL** statement or construct.

The only attributes held by the **FORALL** statement or construct entity are the type and type parameters that it would have if it were the name of a variable in the scoping unit that includes the **FORALL**. It is type integer.

Except for a common block name or a scalar variable name, a name that identifies a global entity or a local entity of class 1, accessible in the scoping unit of a **FORALL** statement or construct, must not be the same as the *index\_name*. Within the scope of a **FORALL** construct, a nested **FORALL** statement or **FORALL** construct must not have the same *index\_name*.

If the name of a global or local entity accessible in the scoping unit of a **FORALL** statement or construct is the same as the *index\_name*, the name is interpreted within the scope of the **FORALL** statement or construct as that of the *index\_name*. Elsewhere in the scoping unit, the name is interpreted as that of the global or local entity.

---

#### End of Fortran 95

---

#### Construct entity:

---

#### Fortran 2003

---

The following is a construct entity:

- The associate name of an **ASSOCIATE** construct.
  - SCOPE: Scope of the block of the **ASSOCIATE** construct.
- The associate name of a **SELECT TYPE** construct.
  - SCOPE: (Separate) Scope of each block of the **SELECT TYPE** construct.

If the name of a global or local entity accessible in the scoping unit of an **ASSOCIATE** or **SELECT TYPE** construct is the same as an associate name, the name is interpreted within the blocks of an **ASSOCIATE** or **SELECT TYPE** construct as that of the associate name. Elsewhere in the scoping unit, the name is

interpreted as the global and local entities.

End of Fortran 2003

---

## Association

Association exists if the same data can be identified with different names in the same scoping unit, or if the same data can be accessed in different scoping units of the same executable program. See “Argument association” on page 183 for information on argument association in procedures and functions.

### Host association

Host association allows an internal subprogram, module subprogram, interface body, or derived-type definition to access named entities that exist in its host. In interface bodies, entities cannot be accessed by host association unless they are made accessible by an **IMPORT** statement. Accessed entities have the same attributes and are known by the same name as they are in the host.

A name that is specified with the **EXTERNAL** attribute is a global name. Any entity in the host scoping unit that has this name as its nongeneric name is inaccessible by that name and by host association.

The following list of entities are local within a scoping unit when declared or initialized in that scoping unit:

- A variable name in a **COMMON** statement or initialized in a **DATA** statement
- An array name in a **DIMENSION** statement
- A name of a derived type
- An object name in a type declaration, **EQUIVALENCE**, **POINTER**, **ALLOCATABLE**, **SAVE**, **TARGET**, **AUTOMATIC**, integer **POINTER**, **STATIC**, or **VOLATILE** statement

**Note:** **VOLATILE** is controlled by compiler option **qxlf2003**. For more information: *XL Fortran Compiler Reference*.

- A named constant in a **PARAMETER** statement
- A namelist group name in a **NAMELIST** statement
- A generic interface name or a defined operator
- An intrinsic procedure name in an **INTRINSIC** statement
- A function name in a **FUNCTION** statement, statement function statement, or type declaration statement
- A result name in a **FUNCTION** statement or an **ENTRY** statement
- A subroutine name in a **SUBROUTINE** statement
- An entry name in an **ENTRY** statement
- A dummy argument name in a **FUNCTION**, **SUBROUTINE**, **ENTRY**, or statement function statement
- The name of a named construct
- The name of an entity declared by an interface body or **PROCEDURE** declaration statement

Entities in the host scoping unit that have the same name as a local entity are not accessible by host association.

A local entity must not be referenced or defined before the **DATA** statement when:

1. An entity is local to a scoping unit only because it is initialized in a **DATA** statement, and
2. An entity in the host has the same name as this local entity.

If a derived-type name of a host is inaccessible, structures of that type or subobjects of such structures are still accessible.

If a subprogram gains access to a pointer (or integer pointer) by host association, the pointer association that exists at the time the subprogram is invoked remains current within the subprogram. This pointer association can be changed within the subprogram. The pointer association remains current when the procedure finishes executing, except when this causes the pointer to become undefined, in which case the association status of the host-associated pointer becomes undefined. For more information on events that cause definition and undefinition of variables, see “Definition status of variables” on page 19.

The host scoping unit of an internal or module subprogram can contain the same use-associated entities.

### Example of host association

```

SUBROUTINE MYSUB
TYPE DATES                      ! Define DATES
  INTEGER START
  INTEGER END
END TYPE DATES
CONTAINS
  INTEGER FUNCTION MYFUNC(PNAME)
  TYPE PLANTS
    TYPE (DATES) LIFESPAN      ! Host association of DATES
    CHARACTER(10) SPECIES
    INTEGER PHOTOPER
  END TYPE PLANTS
  END FUNCTION MYFUNC
END SUBROUTINE MYSUB

```

#### Fortran 2003

Host associated entities are known by the same name and have the same attributes as in the host, except that an accessed entity may have the **VOLATILE** or **ASYNCHRONOUS** attribute even if the host entity does not. In an internal or module procedure, if a variable that is accessible via host association is specified in an **ASYNCHRONOUS** or **VOLATILE** statement, that host variable is given the **ASYNCHRONOUS** or **VOLATILE** attribute in the local scope.

**Note:** **VOLATILE** is controlled by compiler option **qxlf2003**. For more information: *XL Fortran Compiler Reference*.

End of Fortran 2003

## Use association

Use association occurs when a scoping unit accesses the entities of a module with the **USE** statement. Use-associated entities can be renamed for use in the local scoping unit. The association is in effect for the duration of the executable program. See “USE” on page 468 for details.

```

MODULE M
CONTAINS
SUBROUTINE PRINTCHAR(X)
  CHARACTER(20) X

```

```

        PRINT *, X
    END SUBROUTINE
END MODULE
PROGRAM MAIN
USE M
CHARACTER(20) :: NAME='George'
CALL PRINTCHAR(NAME)
END

```

Fortran 2003

A **USE** associated entity may have the **ASYNCHRONOUS** or **VOLATILE** attribute in the local scoping unit even if the associated module entity does not.

**Note:** **VOLATILE** is controlled by compiler option **qxlf2003**. For more information: *XL Fortran Compiler Reference*.

End of Fortran 2003

## Construct Association

Fortran 2003

Construct association establishes an association between each selector and the corresponding associate name of the construct. Each associate name remains associated with the corresponding selector throughout the execution of the executed block. Within the block, each selector is known by and may be accessed by the corresponding associate name. Construct termination terminates the association as well. See the **ASSOCIATE** and **SELECT TYPE** constructs for more information.

End of Fortran 2003

## Pointer association

A target that is associated with a pointer can be referenced by a reference to the pointer. This is called pointer association.

A pointer always has an association status:

*Associated*

- The **ALLOCATE** statement successfully allocates the pointer, which has not been subsequently disassociated or undefined.

```
ALLOCATE (P(3))
```

- The pointer is pointer-assigned to a target that is currently associated or has the **TARGET** attribute and, if allocatable, is currently allocated.

```
P => T
```

*Disassociated*

- The pointer is nullified by a **NULLIFY** statement or by the **-qinit=f90ptr** option. See **-qinit** in the *XL Fortran Compiler Reference*.

```
NULLIFY (P)
```

Fortran 2003

- The pointer is an ultimate component of an object with default initialization specified for the component and:

- a procedure is invoked with this object as an actual argument corresponding to a nonpointer, nonallocatable dummy argument with **INTENT(OUT)**,
- a procedure with the object as an unsaved nonpointer, nonallocatable local object that is not accessed by use or host association is invoked,
- this object is allocated, or

End of Fortran 2003

- The pointer is successfully deallocated.  
DEALLOCATE (P)
- The pointer is pointer-assigned to a disassociated pointer.  
NULLIFY (Q); P => Q

*Undefined*

- Initially (unless the **-qinit=f90ptr** option is specified)

Fortran 2003

- The pointer is an ultimate component of an object, default initialization is not specified for the component, and a procedure is invoked with this object as an actual argument corresponding to a dummy argument with **INTENT(OUT)**, or a procedure is invoked with the pointer as an actual argument corresponding to a pointer dummy argument with **INTENT(OUT)**.

End of Fortran 2003

- If it is pointer-assigned to a pointer whose association status is undefined.
- If its target was deallocated other than through the pointer.  

```

POINTER P(:), Q(:)
ALLOCATE (P(3))
Q => P
DEALLOCATE (Q)    ! Deallocate target of P through Q.
                  ! P is now undefined.
END

```
- If the execution of a **RETURN** or **END** statement causes the pointer's target to become undefined.
- After the execution of a **RETURN** or **END** statement in a procedure where the pointer was declared or accessed, except for objects described in item 4 under "Events causing undefinition" on page 23.

### Definition status and association status

The definition status of a pointer is that of its target. If a pointer is associated with a definable target, the definition status of the pointer can be defined or undefined according to the rules for a variable.

If the association status of a pointer is disassociated or undefined, the pointer must not be referenced or deallocated. Whatever its association status, a pointer can always be nullified, allocated or pointer-assigned. When it is allocated, its definition status is undefined. When it is pointer-assigned, its association and definition status are determined by its target. So, if a pointer becomes associated with a target that is defined, the pointer becomes defined.

## Integer pointer association

### IBM Extension

An integer pointer that is associated with a data object can be used to reference the data object. This is called integer pointer association.

Integer pointer association can only occur in the following situations:

- An integer pointer is assigned the address of a variable:

```
POINTER (P,A)
P=LOC(B)           ! A and B become associated
```

- Multiple pointees are declared with the same integer pointer:

```
POINTER (P,A), (P,B) ! A and B are associated
```

- Multiple integer pointers are assigned the address of the same variable or the address of other variables that are storage associated:

```
POINTER (P,A), (Q,B)
P=LOC(C)
Q=LOC(C)           ! A, B, and C become associated
```

- An integer pointer variable that appears as a dummy argument is assigned the address of another dummy argument or member of a common block:

```
POINTER (P,A)
.
.
CALL SUB (P,B)
.
.
SUBROUTINE SUB (P,X)
POINTER (P,Y)
P=LOC(X)           ! Main program variables A
                   ! and B become associated.
```

### End of IBM Extension

## Program units, procedures, and subprograms

A program unit is a sequence of one or more lines, organized as statements, comments, and directives. Specifically, a program unit can be:

- The main program
- A module
- A block data program unit
- An external function subprogram
- An external subroutine subprogram

An executable program is a collection of program units consisting of one main program and any number of external subprograms, modules, and block data program units.

A subprogram can be invoked by a main program or by another subprogram to perform a particular activity. When a procedure is invoked, the referenced subprogram is executed.

An external or module subprogram can contain multiple **ENTRY** statements. The subprogram defines a procedure for the **SUBROUTINE** or **FUNCTION** statement, as well as one procedure for each **ENTRY** statement.

An external procedure is defined either by an external subprogram or by a program unit in a programming language other than Fortran.

Main programs, external procedures, block data program units, common blocks, entities with binding labels, and modules are global entities. Internal and module procedures are local entities.

## Internal procedures

External subprograms, module subprograms, and main programs can have internal subprograms, whether the internal subprograms are functions or subroutines, as long as the internal subprograms follow the **CONTAINS** statement.

An internal procedure is defined by an internal subprogram. Internal subprograms cannot appear in other internal subprograms. A module procedure is defined by a module subprogram or an entry in a module subprogram. Internal procedures and module procedures are the same as external procedures except that:

- The name of the internal procedure or module procedure is not a global entity
- An internal subprogram must not contain an **ENTRY** statement
- The internal procedure name must not be an argument associated with a dummy procedure
- The internal subprogram or module subprogram has access to host entities by host association

Fortran 2003

- The **BIND** attribute is not allowed on an internal procedure

End of Fortran 2003

### Migration Tip:

Turn your external procedures into internal subprograms or put them into modules. The explicit interface provides type checking.

FORTRAN 77 source

```
PROGRAM MAIN
  INTEGER A
  A=58
  CALL SUB(A)      ! C must be passed
END
SUBROUTINE SUB(A)
  INTEGER A,B,C    ! A must be redeclared
  C=A+B
END
```

Fortran 90/95/2003 source:

```
PROGRAM MAIN
  INTEGER :: A=58
  CALL SUB
CONTAINS
  SUBROUTINE SUB
    INTEGER B,C
    C=A+B          ! A is accessible by host association
  END SUBROUTINE
END
```

## Interface concepts

The interface of a procedure determines the form of the procedure reference. The interface consists of:

- The characteristics of the procedure
- The name of the procedure
- The name and characteristics of each dummy argument
- The generic identifiers of the procedure, if any

The characteristics of a procedure:

- Distinguishing the procedure as a subroutine or a function
- Distinguishing each dummy argument either as a data object, dummy procedure, or alternate return specifier

The characteristics of a dummy data object are its declared type, type parameters (if any), shape, intent, whether it is optional, allocatable, [F2003](#) polymorphic, [F2003](#) a pointer, a target, or has the [F2003](#) VALUE [F2003](#) attribute. Any dependence on other objects for type parameter or array bound determination is a characteristic. If a shape, size, or character length is assumed, it is a characteristic.

The characteristics of a dummy procedure are the explicitness of its interface, its procedure characteristics (if the interface is explicit), and whether it is optional.

- If the procedure is a function, it specifies the characteristics of the result value, specifically:
  - Declared type
  - Any type parameters
  - Rank



- Whether the result value is a pointer
- Whether the result value is allocatable.
- **F2003** Whether the result value is polymorphic **F2003**

For nonpointer, nonallocatable array results, its shape is a characteristic. Any dependence on other objects for type parameters or array bound determination is a characteristic. If the length of a character object is assumed, this is a characteristic.

- Determine whether the procedure is **PURE** or **ELEMENTAL**.
- Determine whether procedure has the **BIND** attribute.

If a procedure is accessible in a scoping unit, it has an interface that is either explicit or implicit in that scoping unit. The rules are:

Entity	Interface
Dummy procedure	Explicit in a scoping unit if an interface block exists or is accessible, or if an explicit interface is specified by a <b>PROCEDURE</b> declaration statement. Implicit in all other cases.
External subprogram	Explicit in a scoping unit other than its own if an interface block exists or is accessible, or if an explicit interface is specified by a <b>PROCEDURE</b> declaration statement. Implicit in all other cases.
Recursive procedure with a result clause	Explicit in the subprogram's own scoping unit.
Module procedure	Always explicit.
Internal procedure	Always explicit.
Generic procedure	Always explicit.
Intrinsic procedure	Always explicit.
Statement function	Always implicit.

Internal subprograms cannot appear in an interface block or in a **PROCEDURE** declaration statement.

A procedure must not have more than one accessible interface in a scoping unit.

The interface of a statement function cannot be specified in an interface block or in a **PROCEDURE** declaration statement.

### Explicit interface

A procedure must have an explicit interface in any of the following cases:

1. A reference to the procedure appears
  - with an argument keyword
  - as a defined assignment (for subroutines only)
  - in an expression as a defined operator (for functions only)
  - as a reference by its generic name
  - **F95** in a context that requires it to be pure **F95**
2. The procedure has
  - a dummy argument that has the **F2003** **ALLOCATABLE**, **F2003** **OPTIONAL**, **POINTER**, **TARGET** or **F2003** **VALUE** **F2003** attributes.
  - **F2003** a dummy argument that is polymorphic **F2003**

- an array-valued result (for functions only)
  - a result whose length type parameter is neither assumed nor constant (for character functions only)
  - a pointer or allocatable result (for functions only)
  - a dummy argument that is an assumed-shape array
3. `F95` The procedure is elemental. `F95`
  4. The procedure has the `F2003` `BIND` `F2003` attribute.

### Implicit interface

A procedure has an implicit interface if its interface is not fully known; that is, it has no explicit interface.

---

## Interface blocks

The interface block allows you to specify an explicit interface for external and dummy procedures. You can also use an interface block to define generic identifiers. An interface body in an interface block contains the explicit specific interface for an existing external procedure or dummy procedure. You can also specify the interface for a procedure using a procedure statement.

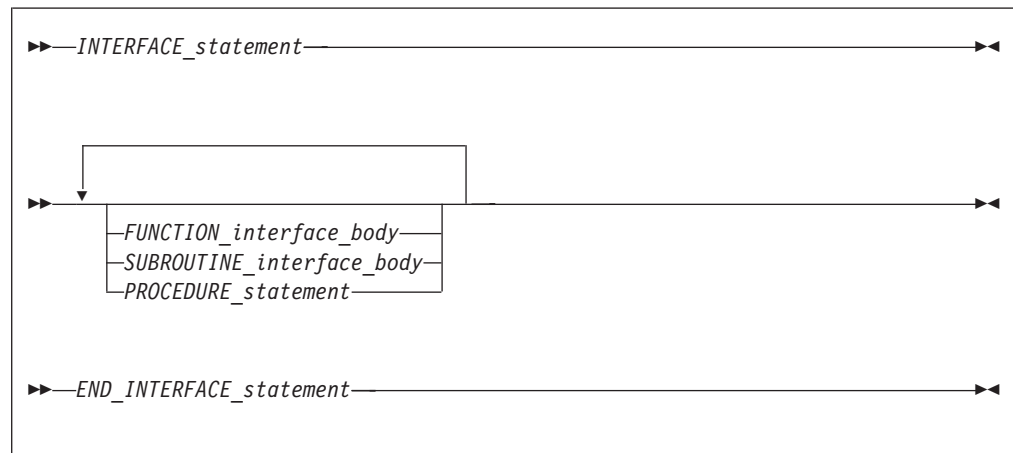

*INTERFACE\_statement*

See "INTERFACE" on page 389 for syntax details

*END\_INTERFACE\_statement*

See "END INTERFACE" on page 339 for syntax details

*PROCEDURE\_statement*

See "PROCEDURE" on page 418 for syntax details

*FUNCTION\_interface\_body*

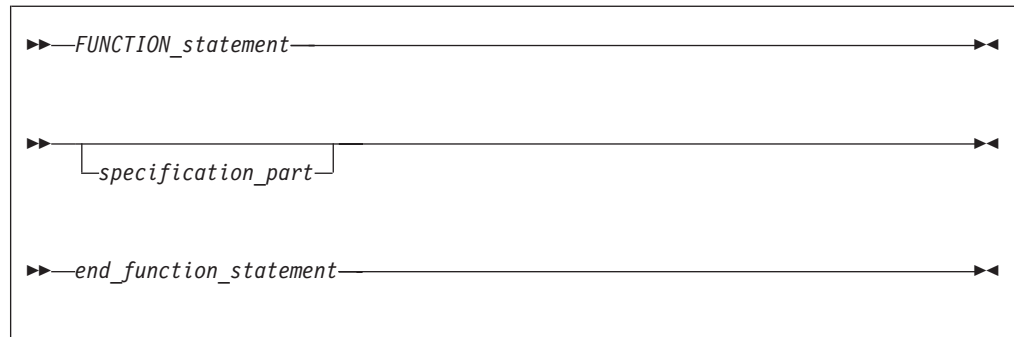

*SUBROUTINE\_interface\_body*

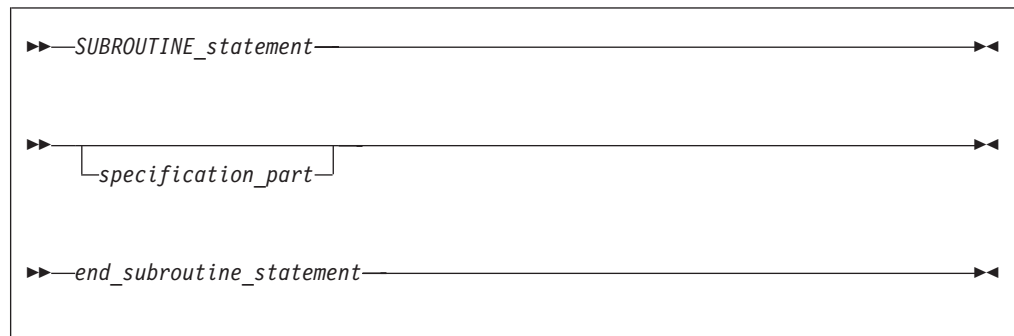

*FUNCTION\_statement, SUBROUTINE\_statement*

For syntax details, see “FUNCTION” on page 362 and “SUBROUTINE” on page 453.

*specification\_part*

is a sequence of statements from the statement groups numbered **2**, **3** and **5** in “Order of statements and execution sequence” on page 14.

*end\_function\_statement, end\_subroutine\_statement*

For syntax details of both statements, see “END” on page 335.

In an interface body or with a procedure declaration statement, you specify all the characteristics of the procedure or abstract interface. See “Interface concepts” on page 156. The characteristics must be consistent with those specified in the subprogram definition, except that:

1. dummy argument names may be different.
2. you do not have to indicate that a procedure is pure, even if the subprogram that defines it is pure.
3. you can associate a pure actual argument with a dummy procedure that is not pure.
4. when you associate an intrinsic elemental procedure with a dummy procedure, the dummy procedure does not have to be elemental

The *specification\_part* of an interface body can contain statements that specify attributes or define values for data objects that do not determine characteristics of the procedure. Such specification statements have no effect on the interface. Interface blocks do not specify the characteristics of module procedures, whose characteristics are defined in the module subprogram definitions.

An interface body cannot contain **ENTRY** statements, **DATA** statements, **FORMAT** statements, statement function statements, or executable statements. You can specify an entry interface by using the entry name as the procedure name in an interface body.

An interface body does not access named entities by host association unless you specify the `IMPORT` statement. It is treated as if it had a host with the default implicit rules. See “Determining Type” on page 17 for a discussion of the implicit rules.

An interface block can be abstract, generic or specific. A generic interface block must specify a generic specification in the **INTERFACE** statement, while an abstract or specific interface block must not specify such a generic specification. See “INTERFACE” on page 389 for details.

The interface bodies within an abstract or specific interface block can contain interfaces for both subroutines and functions.

A generic name specifies a single name to reference all of the procedures in the interface block. At most, one specific procedure is invoked each time there is a procedure reference with a generic name.

The **PROCEDURE** statement is allowed only if the interface block has a generic specification and is contained in a scoping unit where each procedure name is accessible.

A procedure name used in a **PROCEDURE** statement must not have been previously specified in any **MODULE PROCEDURE** statement in any accessible interface block with the same generic identifier.

#### IBM Extension

For an interface to a non-Fortran subprogram, the dummy argument list in the **FUNCTION** or **SUBROUTINE** statement can explicitly specify the passing method. See “Dummy arguments” on page 182 for details.

#### End of IBM Extension

## Example of an interface block

```
MODULE M
CONTAINS
SUBROUTINE S1(IARG)
  IARG = 1
END SUBROUTINE S1
SUBROUTINE S2(RARG)
  RARG = 1.1
END SUBROUTINE S2
SUBROUTINE S3(LARG)
  LOGICAL LARG
  LARG = .TRUE.
END SUBROUTINE S3
END

USE M
INTERFACE SS
  SUBROUTINE SS1(IARG,JARG)
  END SUBROUTINE
MODULE PROCEDURE S1,S2,S3
```

```

END INTERFACE
CALL SS(II)           ! Calls subroutine S1 from M
CALL SS(I,J)         ! Calls subroutine SS1
END

SUBROUTINE SS1(IARG,JARG)
  IARG = 2
  JARG = 3
END SUBROUTINE

```

You can always reference a procedure through its specific interface. If a generic interface exists for a procedure, the procedure can also be referenced through the generic interface.

Within an interface body, if a dummy argument is intended to be a dummy procedure, it must have the **EXTERNAL** attribute or there must be an interface for the dummy argument.

---

## Generic interface blocks

In an **INTERFACE** statement, a generic interface block must specify one of the following:

- a generic name
- defined operator
- defined assignment
- **F2003** a derived-type input/output generic specification **F2003**

The generic name is a single name with which to reference all of the procedures specified in the interface block. It can be the same as any accessible generic name, or any of the procedure names in the interface block.

If two or more generic interfaces that are accessible in a scoping unit have the same local name, they are interpreted as a single generic interface.

## Unambiguous generic procedure references

When making a reference to a generic procedure, only one specific procedure is invoked. This section includes rules that ensure a generic reference is unambiguous.

If two procedures in the same scoping unit both define assignment or both have the same defined operator and the same number of arguments, you must specify a dummy argument that corresponds by position in the argument list to a dummy argument of the other that is distinguishable from it. **F2003** Two dummy arguments are distinguishable if neither is a subroutine and neither is TKR-compatible with the other. **F2003**

Within a scoping unit, if two procedures have the same *dtio\_generic\_spec*, their *dtv* arguments must be type-incompatible or have different kind type parameters. (For information on *dtio\_generic\_spec* specifications and the *dtv* argument, see “User-defined derived-type Input/Output procedure interfaces” on page 210).

Within a scoping unit, two procedures that have the same generic name must both be subroutines or both be functions. They must also adhere to the following conditions:

1. One of the procedures contains a non-passed-object dummy argument such that:

- a. the number of dummy arguments in one procedure that are nonoptional, not passed-object, and with which the dummy argument is TKR-compatible, possibly including the dummy argument itself, exceeds
  - b. the number of non-passed-object dummy arguments, both optional and nonoptional, in the other procedure that are not distinguishable from the dummy argument.
2. Both procedures have passed-object dummy arguments, which are distinguishable.
  3. At least one of the procedures has both:
    - a. a nonoptional non-passed-object dummy argument at an effective position such that either the other procedure has no dummy argument at that effective position or the dummy argument at that position is distinguishable from it
    - b. a nonoptional non-passed-object dummy argument whose name is such that either the other procedure has no dummy argument with that name or the dummy argument with that name is distinguishable from it.

The dummy argument that disambiguates by position must either be the same as, or occur earlier in the argument list than, the one that disambiguates by name.

The effective position of a dummy argument is its position in the argument list after any passed-object dummy argument has been removed.

When an interface block extends an intrinsic procedure, the rules in this section apply as if the intrinsic procedure consists of a collection of specific procedures, one procedure for each allowed set of arguments.

---

**IBM Extension**

---

**Notes:**

1. Dummy arguments of type **BYTE** are considered to have the same type as corresponding 1-byte dummy arguments of type **INTEGER(1)**, **LOGICAL(1)**, and character.
2. When the **-qintlog** compiler option is specified, dummy arguments of type integer and logical are considered to have the same type as corresponding dummy arguments of type integer and logical with the same kind type parameter.
3. If the dummy argument is only declared with the **EXTERNAL** attribute within an interface body, the dummy argument must be the only dummy argument corresponding by position to a procedure, and it must be the only dummy argument corresponding by argument keyword to a procedure.

---

End of IBM Extension

---

### Example of a generic interface block

```
PROGRAM MAIN
INTERFACE A
  FUNCTION AI(X)
    INTEGER AI, X
  END FUNCTION AI
END INTERFACE
INTERFACE A
  FUNCTION AR(X)
    REAL AR, X
  END FUNCTION AR
END INTERFACE
```

```

INTERFACE FUNC
  FUNCTION FUNC1(I, EXT)      ! Here, EXT is a procedure
    INTEGER I
    EXTERNAL EXT
  END FUNCTION FUNC1
  FUNCTION FUNC2(EXT, I)
    INTEGER I
    REAL EXT                  ! Here, EXT is a variable
  END FUNCTION FUNC2
END INTERFACE
EXTERNAL MYFUNC
IRESULT=A(INTVAL)            ! Call to function AI
RRESULT=A-REALVAL)          ! Call to function AR
RESULT=FUNC(1,MYFUNC)       ! Call to function FUNC1
END PROGRAM MAIN

```

## Extending intrinsic procedures with generic interface blocks

A generic intrinsic procedure can be extended or redefined. An extended intrinsic procedure supplements the existing specific intrinsic procedures. A redefined intrinsic procedure replaces an existing specific intrinsic procedure.

When a generic name is the same as a generic intrinsic procedure name and the name has the **INTRINSIC** attribute (or appears in an intrinsic context), the generic interface extends the generic intrinsic procedure.

When a generic name is the same as a generic intrinsic procedure name and the name does not have the **INTRINSIC** attribute (nor appears in an intrinsic context), the generic interface can redefine the generic intrinsic procedure.

A generic interface name cannot be the same as a specific intrinsic procedure name if the name has the **INTRINSIC** attribute (or appears in an intrinsic context).

### Example of extending and redefining intrinsic procedures

```

PROGRAM MAIN
  INTRINSIC MAX
  INTERFACE MAX                ! Extension to intrinsic MAX
    FUNCTION MAXCHAR(STRING)
      CHARACTER(50) STRING
    END FUNCTION MAXCHAR
  END INTERFACE
  INTERFACE ABS                ! Redefines generic ABS as
    FUNCTION MYABS(ARG)        ! ABS does not appear in
      REAL(8) MYABS, ARG       ! an INTRINSIC statement
    END FUNCTION MYABS
  END INTERFACE
  REAL(8) DARG, DARG
  REAL(4) RANS
  INTEGER IANS, IARG
  CHARACTER(50) NAME
  DARG = ABS(DARG)             ! Calls external MYABS
  IANS = ABS(IARG)             ! Calls intrinsic IABS
  DARG = DABS(DARG)            ! Calls intrinsic DABS
  IANS = MAX(NAME)             ! Calls external MAXCHAR
  RANS = MAX(1.0,2.0)          ! Calls intrinsic AMAX1
END PROGRAM MAIN

```

## Defined operators

A defined operator is a user-defined unary or binary operator, or an extended intrinsic operator (see “Extended intrinsic and defined operations” on page 106). It must be defined by both a function and a generic interface block.

1. To define the unary operation  $op x_1$ :

- a. A function or entry must exist that specifies exactly one dummy argument,  $d_1$ .

Fortran 2003

- b. Either:
  - 1) the *generic\_spec* in an **INTERFACE** statement specifies **OPERATOR** (*op*), or
  - 2) there is a generic binding in the declared type of  $x_1$  with a *generic\_spec* of **OPERATOR**(**op**) and there is a corresponding binding to the function in the dynamic type of  $x_1$ .

End of Fortran 2003

- c. The dynamic type of  $x_1$  is compatible with the type of the dummy argument  $d_1$ .
- d. The type parameters, if any, of  $x_1$  must match those of  $d_1$ .
- e. Either
  - The function is **ELEMENTAL**, or
  - The rank of  $x_1$ , and its shape, if it is an array, match those of  $d_1$
2. To define the binary operation  $x_1$  *op*  $x_2$ :
  - a. The function is specified with a **FUNCTION** or **ENTRY** statement that specifies two dummy arguments,  $d_1$  and  $d_2$ .

Fortran 2003

- b. Either:
  - 1) the *generic\_spec* in an **INTERFACE** block specifies **OPERATOR** (*op*), or
  - 2) there is a generic binding in the declared type of  $x_1$  or  $x_2$  with a *generic\_spec* of **OPERATOR**(**op**) and there is a corresponding binding to the function in the dynamic type of  $x_1$  or  $x_2$ , respectively.

End of Fortran 2003

- c. The dynamic types of  $x_1$  and  $x_2$  are compatible with the types of the dummy arguments  $d_1$  and  $d_2$ , respectively.
- d. The type parameters, if any, of  $x_1$  and  $x_2$  match those of  $d_1$  and  $d_2$ , respectively.
- e. Either:
  - The function is **ELEMENTAL** and  $x_1$  and  $x_2$  are conformable or,
  - The ranks of  $x_1$  and  $x_2$  and their shapes, if either or both are arrays, match those of  $d_1$  and  $d_2$ , respectively.
3. If *op* is an intrinsic operator, the types or ranks of either  $x_1$  or  $x_2$  are not those required for an intrinsic operation.
4. The *generic\_spec* must not specify **OPERATOR** for functions with no arguments or for functions with more than two arguments.
5. Each argument must be nonoptional.
6. The arguments must be specified with **INTENT**(**IN**).
7. Each function specified in the interface cannot have a result of assumed character length.
8. If the operator specified is an intrinsic operator, the number of function arguments must be consistent with the intrinsic uses of that operator.
9. A given defined operator can, as with generic names, apply to more than one function, in which case it is generic just like generic procedure names. For intrinsic operator symbols, the generic properties include the intrinsic



operations they represent.

#### IBM Extension

10. The following rules apply only to extended intrinsic operations:
  - a. The type of one of the arguments can only be of type **BYTE** when the type of the other argument is of derived type.
  - b. When the **-qintlog** compiler option has been specified for non-character operations, and  $d_1$  is numeric or logical, then  $d_2$  must not be numeric or logical.
  - c. When the **-qctyp1ss** compiler option has been specified for non-character operations, if  $x_1$  is numeric or logical and  $x_2$  is a character constant, the intrinsic operation is performed.

#### End of IBM Extension

### Example of a defined operator

```
INTERFACE OPERATOR (.DETERMINANT.)
  FUNCTION IDETERMINANT (ARRAY)
    INTEGER, INTENT(IN), DIMENSION (:,:) :: ARRAY
    INTEGER IDETERMINANT
  END FUNCTION
END INTERFACE
END
```

### Defined assignment

A defined assignment is treated as a reference to a subroutine, with the left-hand side as the first argument and the right-hand side enclosed in parentheses as the second argument.

1. To define the defined assignment  $x_1 = x_2$ :
  - a. The subroutine is specified with a **SUBROUTINE** or **ENTRY** statement that specifies two dummy arguments,  $d_1$  and  $d_2$ .

#### Fortran 2003

- b. Either:
  - 1) the *generic\_spec* of an interface block specifies **ASSIGNMENT (=)**, or
  - 2) there is a generic binding in the declared type of  $x_1$  or  $x_2$  with a *generic\_spec* of **ASSIGNMENT(=)** and there is a corresponding binding to the subroutine in the dynamic type of  $x_1$  or  $x_2$ , respectively.

#### End of Fortran 2003

- c. The dynamic types of  $x_1$  and  $x_2$  are compatible with the types of dummy arguments  $d_1$  and  $d_2$ , respectively.
- d. The type parameters, if any, of  $x_1$  and  $x_2$  match those of  $d_1$  and  $d_2$ , respectively.
- e. Either:
  - The subroutine is **ELEMENTAL** and either  $x_1$  and  $x_2$  have the same shape,  $x_2$  is scalar, or
  - The ranks of  $x_1$  and  $x_2$ , and their shapes, if either or both are arrays, match those of  $d_1$  and  $d_2$ , respectively.
2. **ASSIGNMENT** must only be used for subroutines with exactly two arguments.
3. Each argument must be nonoptional.

4. The first argument must have **INTENT(OUT)** or **INTENT(INOUT)**, and the second argument must have **INTENT(IN)**.
5. The types of the arguments must not be both numeric, both logical, or both character with the same kind parameter.

**IBM Extension**

The type of one of the arguments can only be of type **BYTE** when the type of the other argument is of derived type.

When the **-qintlog** compiler option has been specified, and  $d_1$  is numeric or logical, then  $d_2$  must not be numeric or logical.

When the **-qctyp1ss** compiler option has been specified, if  $x_1$  is numeric or logical and  $x_2$  is a character constant, intrinsic assignment is performed.

**End of IBM Extension**

6. The **ASSIGNMENT** generic specification specifies that the assignment operation is extended or redefined if both sides of the equal sign are of the same derived type.

### Example of defined assignment

```
INTERFACE ASSIGNMENT(=)
  SUBROUTINE BIT_TO_NUMERIC (N,B)
    INTEGER, INTENT(OUT) :: N
    LOGICAL, INTENT(IN), DIMENSION(:) :: B
  END SUBROUTINE
END INTERFACE
```

## User-defined derived-type Input/Output procedures

**Fortran 2003**

User-defined derived-type input/output procedures allow a program to override the default handling of derived-type objects and values in data transfer input/output statements.

There are four interfaces, one each for formatted input, formatted output, unformatted input, and unformatted output which specify the characteristics of the four procedures. The four interfaces use a *dtv* type specification, or *dtv\_type\_spec*. The syntax for the *dtv\_type\_spec* is as follows:

▶ `TYPE` (`—derived_type_spec—`) ▶  
     └── `CLASS` ─┘

If *derived\_type\_spec* specifies an extensible type, use the **CLASS** keyword; otherwise, use the **TYPE** keyword.

The following table shows the required characteristics of the user-defined procedures for each of the four *dtio\_generic\_spec* specifications of the interface block or generic binding:

Table 17. Interfaces for user-defined derived-type input/output procedures

<i>dtio_generic_spec</i>	<b>Interface</b>
<b>READ (FORMATTED)</b>	<pre> SUBROUTINE my_read_routine_formatted &amp; (dtv, &amp; unit, &amp; iotype, v_list, &amp; iostat, iomsg) INTEGER, INTENT(IN) :: unit ! unit number ! the derived-type value/variable dtv_type_spec , INTENT(INOUT) :: dtv ! the edit descriptor string CHARACTER (LEN=*), INTENT(IN) :: iotype INTEGER, INTENT(IN) :: v_list(:) INTEGER, INTENT(OUT) :: iostat CHARACTER (LEN=*), INTENT(INOUT) :: iomsg END </pre>
<b>READ (UNFORMATTED)</b>	<pre> SUBROUTINE my_read_routine_unformatted &amp; (dtv, &amp; unit, &amp; iostat, iomsg) INTEGER, INTENT(IN) :: unit ! the derived-type value/variable dtv_type_spec , INTENT(INOUT) :: dtv INTEGER, INTENT(OUT) :: iostat CHARACTER (LEN=*), INTENT(INOUT) :: iomsg END </pre>
<b>WRITE (FORMATTED)</b>	<pre> SUBROUTINE my_write_routine_formatted &amp; (dtv, &amp; unit, &amp; iotype, v_list, &amp; iostat, iomsg) INTEGER, INTENT(IN) :: unit ! the derived-type value/variable dtv_type_spec , INTENT(IN) :: dtv ! the edit descriptor string CHARACTER (LEN=*), INTENT(IN) :: iotype INTEGER, INTENT(IN) :: v_list(:) INTEGER, INTENT(OUT) :: iostat CHARACTER (LEN=*), INTENT(INOUT) :: iomsg END </pre>
<b>WRITE (UNFORMATTED)</b>	<pre> SUBROUTINE my_write_routine_unformatted &amp; (dtv, &amp; unit, &amp; iostat, iomsg) INTEGER, INTENT(IN) :: unit ! the derived-type value/variable dtv_type_spec , INTENT(IN) :: dtv INTEGER, INTENT(OUT) :: iostat CHARACTER (LEN=*), INTENT(INOUT) :: iomsg END </pre>

**Note:** The actual specific procedure names (the my ... routine ... procedure names above) are not significant. In the discussion here and elsewhere, the dummy arguments in these interfaces are referred by the names given above; the names are, however, arbitrary.

The following are the characteristics of the arguments:

*dtv*

If the parent data transfer statement is a **READ** statement, *dtv* is the argument associated with the effective list item that caused the user-defined derived-type input procedure to be invoked, as if the effective list item were an actual argument in this procedure reference. If the parent data transfer statement is a **WRITE** or **PRINT** statement, *dtv* contains the effective list item.

*unit* When you invoke a user-defined derived-type input/output procedure, *unit* has a value as follows:

- If the parent data transfer statement uses a *file-unit-number*, the value is that of the *file-unit-number*.
- If the parent data transfer statement is a **WRITE** statement with an asterisk unit or a **PRINT** statement, the value is the same as that of the `OUTPUT_UNIT` named constant of the `ISO_FORTRAN_ENV` intrinsic module.
- If the parent data transfer statement is a **READ** statement with an asterisk unit or a **READ** statement without an *io-control-spec-list*, the value is the same as that of the `INPUT_UNIT` named constant of the `ISO_FORTRAN_ENV` intrinsic module.
- Otherwise the parent data transfer statement must access an internal file. In this case the value is negative.

*iotype* For formatted data transfer, *iotype* has a value as follows:

- "**LISTDIRECTED**" if the parent data transfer statement specified list directed formatting
- "**NAMELIST**" if the parent data transfer statement specified namelist formatting
- "**DT**" concatenated with the *char-literal-constant*, if any, of the edit descriptor, if the parent data transfer statement contained a format specification and the list item's corresponding edit descriptor was a **DT** edit descriptor.

*v\_list* For formatted data transfer, *v\_list* has values as follows:

- If the *v-list* of the edit descriptor appears in the parent data transfer statement, *v\_list* contains the values specified in *v-list*, with the same number of elements, in the same order.
- If there is no *v-list* in the edit descriptor or if the data transfer statement specifies list-directed or namelist formatting, *v\_list* is a zero-sized array.

*iostat* is used to report whether an error, end-of-record, or end-of-file condition occurs. Values are assigned to *iostat* as follows:

- If an error condition occurs, the value is positive.
- If an end-of-file condition occurs, the value is that of the named constant `IOSTAT_END`.
- If an end-of-record condition occurs, the value is that of the named constant `IOSTAT_EOR`.
- Otherwise, the value is zero.

*iormsg* If the *iostat* argument returns a nonzero value, the procedure returns an explanatory message in *iormsg*. Otherwise, the procedure does not change the value of the *iormsg* argument.

End of Fortran 2003

## Abstract interface

### Fortran 2003

An abstract interface allows you to specify procedure characteristics and dummy argument names without declaring a procedure with those characteristics. You can use an abstract interface to declare interfaces for procedures and deferred bindings. The procedure names defined in an abstract interface block do not have an **EXTERNAL** attribute.

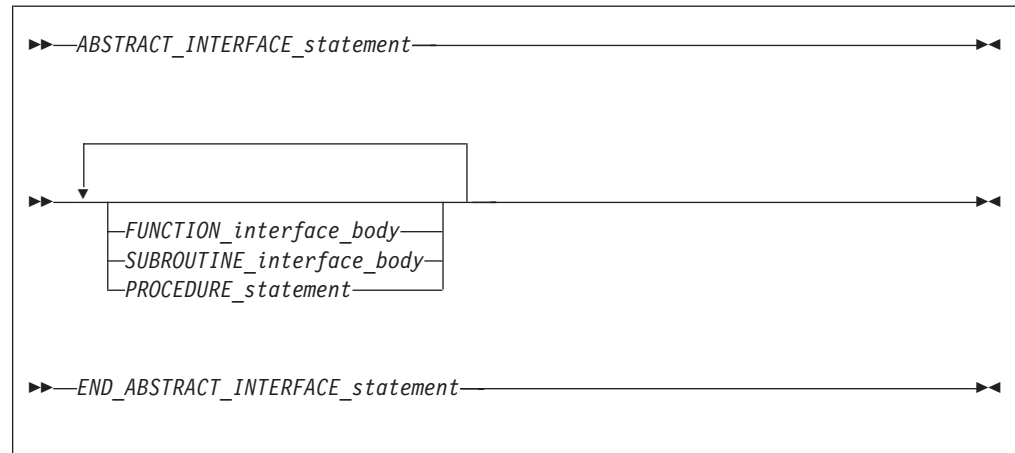

*ABSTRACT\_INTERFACE\_statement*

See “ABSTRACT” on page 273 for syntax details

*FUNCTION\_interface\_body*

See “Interface blocks” on page 158 for syntax details

*SUBROUTINE\_interface\_body*

See “Interface blocks” on page 158 for syntax details

*PROCEDURE\_statement*

See “PROCEDURE” on page 418 for syntax details

*END\_ABSTRACT\_INTERFACE\_statement*

See “END INTERFACE” on page 339 for syntax details

For more information see:

- PROCEDURE declaration “PROCEDURE declaration” on page 419
- external procedures “Program units, procedures, and subprograms” on page 154
- dummy procedures “Procedures as dummy arguments” on page 192
- module procedures “Modules” on page 171

## Example of an abstract interface

```
MODULE M
  ABSTRACT INTERFACE
    SUBROUTINE SUB(X,Y)
      INTEGER ,INTENT(IN)::X
      INTEGER ,INTENT(IN)::Y
    END SUBROUTINE
  END INTERFACE
END MODULE
```

```
PROGRAM MAIN
```

```

USE M
PROCEDURE (SUB) SUB1
PROCEDURE (SUB), POINTER::P
P=>SUB1
CALL P(5,10)
END PROGRAM

SUBROUTINE SUB1 (X,Y)
  INTEGER ,INTENT(IN)::X
  INTEGER ,INTENT(IN)::Y
  PRINT*, "The sum of X and Y is: ", X + Y
END SUBROUTINE

```

End of Fortran 2003

## Main program

A main program is the program unit that receives control from the system when the executable program is invoked at run time.



*PROGRAM\_statement*

See “PROGRAM” on page 422 for syntax details

*specification\_part*

is a sequence of statements from the statement groups numbered **2**, **4**, and **5** in “Order of statements and execution sequence” on page 14

*execution\_part*

is a sequence of statements from the statement groups numbered **4** and **6** in “Order of statements and execution sequence” on page 14, and which must begin with a statement from statement group **6**

*internal\_subprogram\_part*

See “Internal procedures” on page 155 for details

*END\_PROGRAM\_statement*

See “END” on page 335 for syntax details

A main program cannot contain an **ENTRY** statement, nor can it specify an automatic object.

**IBM Extension**

A **RETURN** statement can appear in a main program. The execution of a **RETURN** statement has the same effect as the execution of an **END** statement.

**End of IBM Extension**

---

## Modules

A module contains specifications and definitions that can be accessed from other program units. These definitions include data object definitions, namelist groups, derived-type definitions, procedure interface blocks and procedure definitions.

**Fortran 2003**

There are two types of modules, intrinsic and nonintrinsic. XL Fortran provides intrinsic modules, while nonintrinsic modules are user-defined.

An intrinsic module can have the same name as other global entities, such as program units, common blocks, external procedures, critical sections, or binding labels of global entities. A scoping unit must not access both an intrinsic module and a non-intrinsic module with the same name.

**End of Fortran 2003**

**IBM Extension**

Modules define global data, which, like **COMMON** data, is shared across threads and is therefore thread-unsafe. To make an application thread-safe, you must declare the global data as **THREADPRIVATE** or **THREADLOCAL**. See “**COMMON**” on page 303, **THREADLOCAL**, and **THREADPRIVATE** in the *XL Fortran Optimization and Programming Guide* for more information.

**End of IBM Extension**

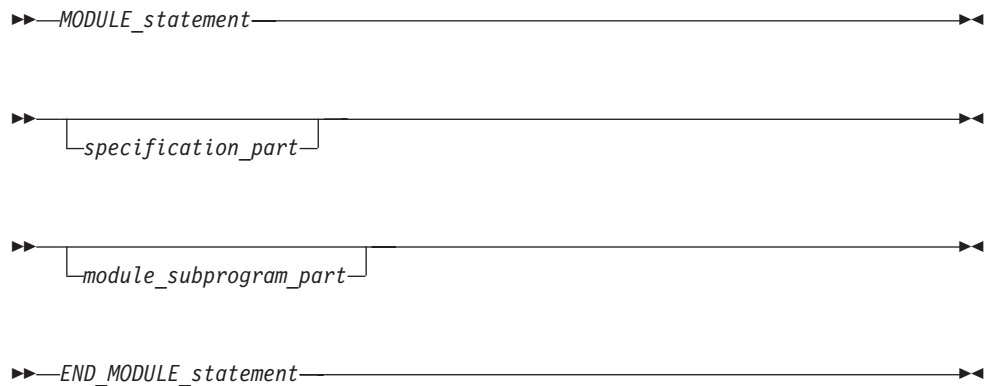

*MODULE\_statement*

See “**MODULE**” on page 397 for syntax details

*specification\_part*

is a sequence of statements from the statement groups numbered **2**, **4**, and **5** in “Order of statements and execution sequence” on page 14

*module\_subprogram\_part*:

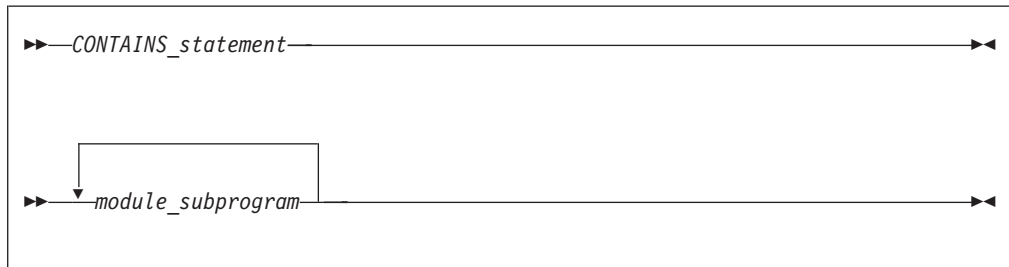

*CONTAINS\_statement*

See “CONTAINS” on page 312 for syntax details

*END\_MODULE\_statement*

See “END” on page 335 for syntax details

A module subprogram is contained in a module but is not an internal subprogram. Module subprograms must follow a **CONTAINS** statement, and can contain internal procedures. A module procedure is defined by a module subprogram or an entry in a module subprogram.

Executable statements within a module can only be specified in module subprograms.

The declaration of a module function name of type character cannot have an asterisk as a length specification.

*specification\_part* cannot contain statement function statements, **ENTRY** statements, or **FORMAT** statements, although these statements can appear in the specification part of a module subprogram.

Automatic objects and objects with the **AUTOMATIC** attribute cannot appear in the scope of a module.

An accessible module procedure can be invoked by another subprogram in the module or by any scoping unit outside the module through use association (that is, by using the **USE** statement). See “USE” on page 468 for details.

#### IBM Extension

Integer pointers cannot appear in *specification\_part* if the pointee specifies a dimension declarator with nonconstant bounds.

All objects in the scope of a module retain their association status, allocation status, definition status, and value when any procedure that accesses the module through use association executes a **RETURN** or **END** statement. See point 4 under “Events causing undefinition” on page 23 for more information.

End of IBM Extension



A module is a host to any module procedures, interface blocks, or derived-type definitions it contains, which can access entities in the scope of the module through host association.

A module procedure can be used as an actual argument associated with a dummy procedure argument.

The name of a module procedure is local to the scope of the module and cannot be the same as the name of any entity in the module, except for a common block name.

**Migration Tips:**

- Eliminate common blocks and **INCLUDE** directives
- Use modules to hold global data and procedures to ensure consistency of definitions

FORTRAN 77 source:

```
COMMON /BLOCK/A, B, C, NAME, NUMBER
REAL A, B, C
A = 3
CALL CALLUP(D)
PRINT *, NAME, NUMBER
END
SUBROUTINE CALLUP (PARM)
COMMON /BLOCK/A, B, C, NAME, NUMBER
REAL A, B, C
...
NAME = 3
NUMBER = 4
END
```

Fortran 90/95/2003 source:

```
MODULE FUNCS
REAL A, B, C           ! Common block no longer needed
INTEGER NAME, NUMBER  ! Global data
CONTAINS
  SUBROUTINE CALLUP (PARM)
    ...
    NAME = 3
    NUMBER = 4
  END SUBROUTINE
END MODULE FUNCS
PROGRAM MAIN
USE FUNCS
A = 3
CALL CALLUP(D)
PRINT *, NAME, NUMBER
END
```

## Example of a module

```
MODULE M
INTEGER SOME_DATA
CONTAINS
  SUBROUTINE SUB()           ! Module subprogram
    INTEGER STMTFNC
    STMTFNC(I) = I + 1
    SOME_DATA = STMTFNC(5) + INNER(3)
  CONTAINS
    INTEGER FUNCTION INNER(IARG) ! Internal subprogram
      INNER = IARG * 2
    END FUNCTION
```

```

      END SUBROUTINE SUB
END MODULE
PROGRAM MAIN
  USE M
  CALL SUB()
END PROGRAM
! Main program accesses
! module M

```

## Block data program unit

A block data program unit provides initial values for objects in named common blocks.

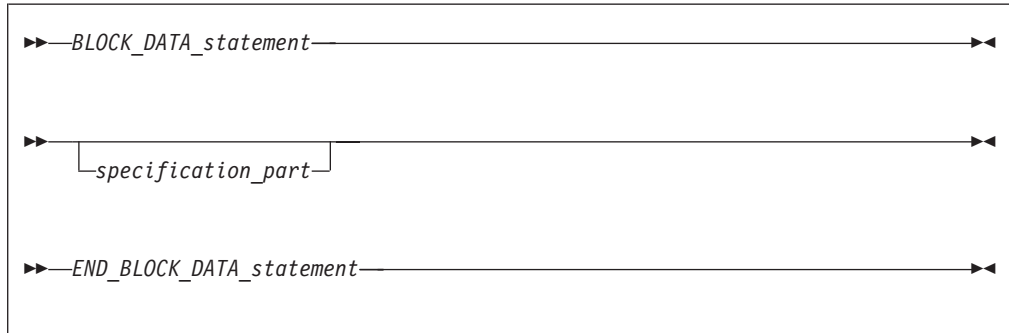

*BLOCK\_DATA\_statement*

See “BLOCK DATA” on page 286 for syntax details

*specification\_part*

is a sequence of statements from the statement groups numbered **2**, **4**, and **5** in “Order of statements and execution sequence” on page 14

*END\_BLOCK\_DATA\_statement*

See “END” on page 335 for syntax details

In *specification\_part*, you can specify type declaration, **USE**, **IMPLICIT**, **COMMON**, **DATA**, **EQUIVALENCE**, and integer pointer statements, derived-type definitions, and the allowable attribute specification statements. The only attributes that can be specified are: **BIND**, **DIMENSION**, **INTRINSIC**, **PARAMETER**, **POINTER**, **SAVE**, **TARGET**, and **ASYNCHRONOUS**.

A type declaration statement in a block data *specification-part* must not contain **ALLOCATABLE** or **EXTERNAL** attribute specifiers.

You can have more than one block data program unit in an executable program, but only one can be unnamed. You can also initialize multiple named common blocks in a block data program unit.

Restrictions on common blocks in block data program units are:

- All items in a named common block must appear in the **COMMON** statement, even if they are not all initialized.
- The same named common block must not be referenced in two different block data program units.
- Only nonpointer objects in named common blocks can be initialized in block data program units.
- Objects in blank common blocks cannot be initialized.

## Example of a block data program unit

```
PROGRAM MAIN
  COMMON /L3/ C, X(10)
  COMMON /L4/ Y(5)
END PROGRAM
BLOCK DATA BDATA
  COMMON /L3/ C, X(10)
  DATA C, X /1.0, 10*2.0/ ! Initializing common block L3
END BLOCK DATA

BLOCK DATA ! An unnamed block data program unit
  PARAMETER (Z=10)
  DIMENSION Y(5)
  COMMON /L4/ Y
  DATA Y /5*Z/
END BLOCK DATA
```

---

## Function and subroutine subprograms

A subprogram is either a function or a subroutine, and is either an internal, external, or module subprogram. You can also specify a function in a statement function statement. An external subprogram is a program unit.



*subprogram\_statement*

See “FUNCTION” on page 362 or “SUBROUTINE” on page 453 for syntax details

*specification\_part*

is a sequence of statements from the statement groups numbered **2**, **4** and **5** in “Order of statements and execution sequence” on page 14

*execution\_part*

is a sequence of statements from the statement groups numbered **4** and **6** in “Order of statements and execution sequence” on page 14, and which must begin with a statement from statement group **6**

*internal\_subprogram\_part*

See “Internal procedures” on page 155 for details

*end\_subprogram\_statement*

See “END” on page 335 for syntax details on the **END** statement for functions and subroutines

An internal subprogram is declared *after* the **CONTAINS** statement in the main program, a module subprogram, or an external subprogram, but *before* the **END** statement of the host program. The name of an internal subprogram must not be defined in the specification section in the host scoping unit.

An external procedure has global scope with respect to the executable program. In the calling program unit, you can specify the interface to an external procedure in an interface block or you can define the external procedure name with the **EXTERNAL** attribute.

A subprogram can contain any statement except **PROGRAM**, **BLOCK DATA** and **MODULE** statements. An internal subprogram cannot contain an **ENTRY** statement or an internal subprogram.

## Declaring procedures

An **EXTERNAL** statement, **PROCEDURE** declaration statement, or a procedure component definition statement can be used to declare a procedure.

An **EXTERNAL** statement declares external procedures and dummy procedures. See “EXTERNAL” on page 352.

A **PROCEDURE** declaration statement declares procedure pointers, dummy procedures, and external procedures. For further information on the **PROCEDURE** declaration statement, see “PROCEDURE declaration” on page 419.

A procedure component definition statement declares procedure pointer components of a derived type definition. See “Procedure pointer component” on page 56.

## Procedure pointers

---

**Fortran 2003**

---

A procedure pointer is a procedure that has the **EXTERNAL** and **POINTER** attribute. A derived type component which has been declared with the **PROCEDURE** statement can be a procedure pointer.

A procedure pointer points at a procedure rather than a data object. A procedure pointer can be associated in the same way as a dummy procedure with an external procedure, a module procedure, an intrinsic procedure, or a dummy procedure that is not a procedure pointer. Procedure pointers can have both an explicit and implicit interface, can be structure components and associated using procedure pointer assignment.

A dummy procedure with the pointer attribute is a dummy procedure pointer and its associated actual argument is a procedure pointer.

A procedure pointer shall be storage associated only with another procedure pointer; either both interfaces shall be explicit (the characteristics are the same) or both interfaces shall be implicit (both interfaces will be functions or subroutines with the same type and type parameters).

Although both type-bound procedures and procedure pointer components are invoked through an object, the type-bound procedure which is executed depends upon the type of the invoking object whereas procedure pointer components depend upon the value. The **PASS** attribute defines the passed-object dummy argument of the procedure pointer component

**Example of procedure pointer declaration:**

```
PROCEDURE(PROC), POINTER :: PTR
```

\_\_\_\_\_ End of Fortran 2003 \_\_\_\_\_

## Procedure references

There are two types of procedure references:

- A subroutine is invoked by any of the following:
  - execution of a **CALL** statement
  - execution of a defined assignment statement
  - F2003 user-defined derived-type input/output F2003
  - F2003 execution of finalization F2003
- A function is invoked during evaluation of a function reference or defined operation.

### Function reference

A function reference is used as a primary in an expression:

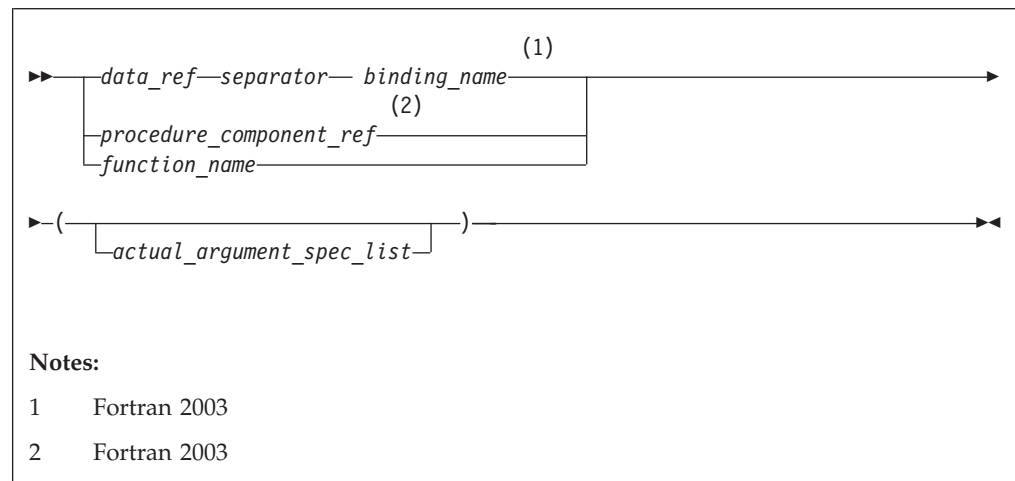

Executing a function reference results in the following order of events:

1. Actual arguments that are expressions are evaluated.
2. Actual arguments are associated with their corresponding dummy arguments.
3. Control transfers to the specified function.
4. The function is executed.
5. The value (or status or target, for pointer functions) of the function result variable is available to the referencing expression.

If the *binding\_name* in a function reference is that of a specific function, the function referenced is the one identified by the binding with that name in the dynamic type of the *data-ref*.

If the *binding\_name* in a function reference is that of a generic procedure, the generic binding with that name in the declared type of the *data-ref* is used to select a specific binding:

1. If the reference is consistent with one of the specific bindings of that generic binding, that specific binding is selected.
2. Otherwise, if the reference is consistent with an elemental reference to one of the specific bindings of that generic binding, that specific binding is selected.

The reference is to the procedure identified by the binding with the same name as the selected specific binding, in the dynamic type of the *data-ref*.

End of Fortran 2003

Execution of a function reference must not alter the value of any other data item within the statement in which the function reference appears. Invocation of a function reference in the logical expression of a logical **IF** statement or **WHERE** statement can affect entities in the statement that is executed when the value of the expression is true.

#### IBM Extension

The argument list built-in functions **%VAL** and **%REF** are supplied to aid interlanguage calls by allowing arguments to be passed by value and by reference, respectively. They can be specified in non-Fortran procedure references and in a subprogram statement in an interface body. (See “%VAL and %REF” on page 184.) See Statement Function and Recursion examples of function references.

End of IBM Extension

On entry to an allocatable function, the allocation status of the result variable becomes not currently allocated

The function result variable may be allocated and deallocated any number of times during the execution of the function. However, it shall be currently allocated and have a defined value on exit from the function. Automatic deallocation of the result variable does not occur immediately on exit from the function, but instead occurs after execution of the statement in which the function reference occurs.

### Examples of subprograms and procedure references

```

MODULE QUAD_MOD
  TYPE QUAD_TYPE
    REAL:: a, b, c
  CONTAINS
    PROCEDURE Q2
  END TYPE

  INTERFACE
    SUBROUTINE Q2(T,QUAD) ! External subroutine
      IMPORT QUAD_TYPE
      CLASS(QUAD_TYPE) T
      REAL QUAD
    END SUBROUTINE
  
```

```

      END INTERFACE
END MODULE
PROGRAM MAIN
  USE QUAD_MOD
  REAL QUAD,X2,X1,X0,A,C3
  TYPE(QUAD_TYPE) QT
  QUAD=0; A=X1*X2
  X2 = 2.0
  X1 = SIN(4.5) ! Reference to intrinsic function
  X0 = 1.0
  QT = QUAD_TYPE(X2, X1, X0)
  CALL Q(X2,X1,X0,QUAD) ! Reference to external subroutine
  CALL QT%Q2(QUAD) ! Reference to a subroutine
  C3 = CUBE() ! Reference to internal function
  CONTAINS
  REAL FUNCTION CUBE() ! Internal function
    CUBE = A**3
  END FUNCTION CUBE
END
SUBROUTINE Q(A,B,C,QUAD) ! External subroutine
  REAL A,B,C,QUAD
  QUAD = (-B + SQRT(B**2-4*A*C)) / (2*A)
END SUBROUTINE Q
SUBROUTINE Q2(T,QUAD) ! External subroutine
  USE QUAD_MOD
  TYPE(QUAD_TYPE) T
  REAL QUAD
  QUAD = (-T%B + SQRT(T%B**2-4*T%A*T%C)) / (2*T%A)
END SUBROUTINE Q2

```

### Examples of allocatable function results

```

FUNCTION INQUIRE_FILES_OPEN() RESULT(OPENED_STATUS)
  LOGICAL,ALLOCATABLE :: OPENED_STATUS(:)
  INTEGER I,J
  LOGICAL TEST
  DO I=1000,0,-1
    INQUIRE(UNIT=I,OPENED=TEST,ERR=100)
    IF (TEST) EXIT
100 CONTINUE
  END DO
  ALLOCATE(OPENED_STATUS(0:I))
  DO J=0,I
    INQUIRE(UNIT=J,OPENED=OPENED_STATUS(J))
  END DO
END FUNCTION INQUIRE_FILES_OPEN

```

---

## Intrinsic procedures

An intrinsic procedure is a procedure already defined by XL Fortran. See Chapter 14, “Intrinsic procedures,” on page 529 for details.

You can reference some intrinsic procedures by a generic name, some by a specific name, and some by both:

### A generic intrinsic function

does not require a specific argument type and usually produces a result of the same type as that of the argument, with some exceptions. Generic names simplify references to intrinsic procedures because the same procedure name can be used with more than one type of argument; the type and kind type parameter of the arguments determine which specific function is used.

### A specific intrinsic function

requires a specific argument type and produces a result of a specific type.

A specific intrinsic function name can be passed as an actual argument. If a specific intrinsic function has the same name as a generic intrinsic function, the specific name is referenced. All references to a dummy procedure that are associated with a specific intrinsic procedure must use arguments that are consistent with the interface of the intrinsic procedure. Specific intrinsic functions may be procedure pointer targets.

Whether or not you can pass the name of an intrinsic procedure as an argument depends on the procedure. You can use the specific name of an intrinsic procedure that has been specified with the **INTRINSIC** attribute as an actual argument in a procedure reference.

- An **IMPLICIT** statement does not change the type of an intrinsic function.
- If an intrinsic name is specified with the **INTRINSIC** attribute, the name is always recognized as an intrinsic procedure.

## Conflicts between intrinsic procedure names and other names

When you declare a data object with the same name as an intrinsic procedure, the intrinsic procedure is inaccessible.

A generic interface block can extend or redefine a generic intrinsic function, as described in “Interface blocks” on page 158. If the function already has the **INTRINSIC** attribute, it is extended; otherwise, it can be redefined.

---

## Arguments

### Actual argument specification

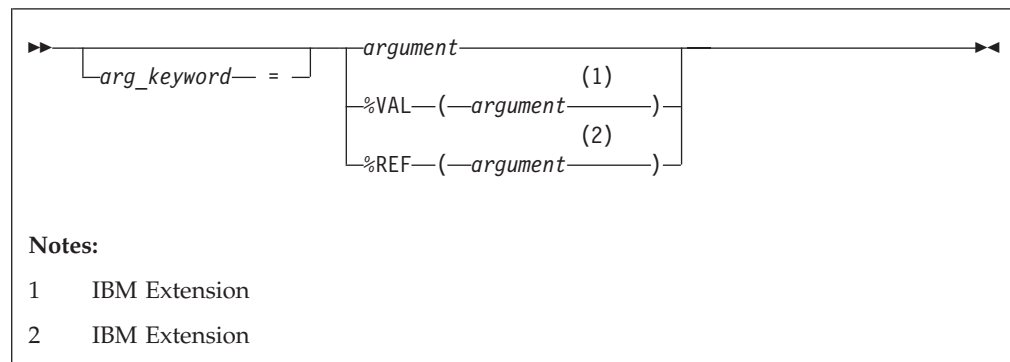

*arg\_keyword*  
is a dummy argument name in the explicit interface of the procedure being invoked

*argument*  
is an actual argument

---

#### IBM Extension

**%VAL, %REF**  
specifies the passing method. See “%VAL and %REF” on page 184 for more information.

---

#### End of IBM Extension





An actual argument appears in the argument list of a procedure reference. An actual argument in a procedure reference can be one of the following:

- An expression
- A variable
- A procedure name
- An alternate return specifier (if the actual argument is in a **CALL** statement), having the form *\*stmt\_label*, where *stmt\_label* is the statement label of a branch target statement in the same scoping unit as the **CALL** statement.

An actual argument specified in a statement function reference must be a scalar object.

A procedure name cannot be the name of an internal procedure, statement function, or the generic name of a procedure, unless it is also a specific name.

The rules and restrictions for referencing a procedure described in “Procedure references” on page 177.  You cannot use a non-intrinsic elemental procedure as an actual argument in Fortran 95. 

### Argument keywords

Argument keywords allow you to specify actual arguments in a different order than the dummy arguments. With argument keywords, any actual arguments that correspond to optional dummy arguments can be omitted; that is, dummy arguments that merely serve as placeholders are not necessary.

Each argument keyword must be the name of a dummy argument in the explicit interface of the procedure being referenced. An argument keyword must not appear in an argument list of a procedure that has an implicit interface.

In the argument list, if an actual argument is specified with an argument keyword, the subsequent actual arguments in the list must also be specified with argument keywords.

An argument keyword cannot be specified for label parameters. Label parameters must appear before referencing the argument keywords in that procedure reference.

#### Example of argument keywords:

```
INTEGER MYARRAY(1:10)
INTERFACE
  SUBROUTINE SORT(ARRAY, DESCENDING, ARRAY_SIZE)
    INTEGER ARRAY_SIZE, ARRAY(ARRAY_SIZE)
    LOGICAL, OPTIONAL :: DESCENDING
  END SUBROUTINE
END INTERFACE
CALL SORT(MYARRAY, ARRAY_SIZE=10) ! No actual argument corresponds to the
                                ! optional dummy argument DESCENDING

END
SUBROUTINE SORT(ARRAY, DESCENDING, ARRAY_SIZE)
  INTEGER ARRAY_SIZE, ARRAY(ARRAY_SIZE)
  LOGICAL, OPTIONAL :: DESCENDING
  IF (PRESENT(DESCENDING)) THEN
    .
    .
    .
  END SUBROUTINE
```

## Dummy arguments

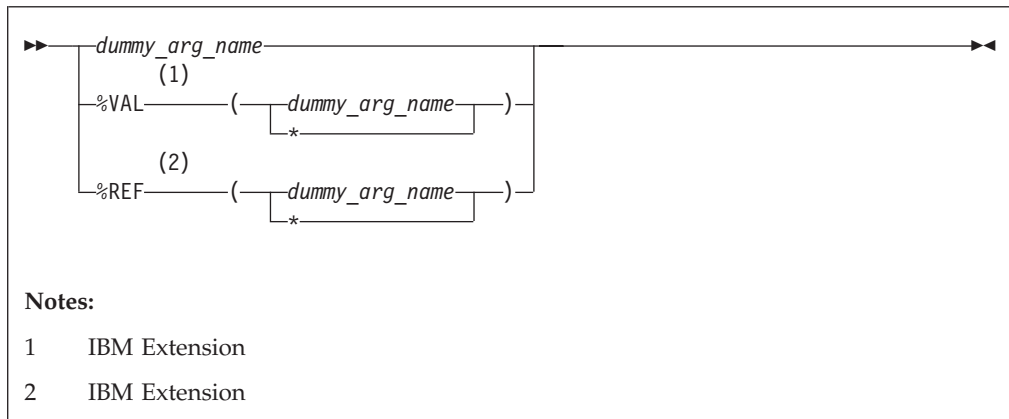

A dummy argument is specified in a Statement Function statement, **FUNCTION** statement, **SUBROUTINE** statement, or **ENTRY** statement. Dummy arguments in statement functions, function subprograms, interface bodies, and subroutine subprograms indicate the types of actual arguments and whether each argument is a scalar value, array, procedure, or statement label. A dummy argument in an external, module, or internal subprogram definition, or in an interface body, is classified as one of the following:

- A variable name
- A procedure name
- An asterisk (in subroutines only, to indicate an alternate return point)

### IBM Extension

`%VAL` or `%REF` can only be specified for a dummy argument in a **FUNCTION** or **SUBROUTINE** statement in an interface block. The interface must be for a non-Fortran procedure interface. If `%VAL` or `%REF` appears in an interface block for an external procedure, this passing method is implied for each reference to that procedure. If an actual argument in an external procedure reference specifies `%VAL` or `%REF`, the same passing method must be specified in the interface block for the corresponding dummy argument. See “`%VAL` and `%REF`” on page 184 for more details.

### End of IBM Extension

A dummy argument in a statement function definition is classified as a variable name.

A given name can appear only once in a dummy argument list.

The name of a variable that appears as a dummy argument in a statement function statement has a scope of the statement in which it appears. It has the type that it would have if it were the name of a variable in the scoping unit that includes the statement function. It cannot have the same name as an accessible array.

---

## Argument association

Actual arguments are associated with dummy arguments when a function or subroutine is referenced. In a procedure reference, the actual argument list identifies the correspondence between the actual arguments provided in the list and the dummy arguments of the subprogram.

---

### Fortran 2003

The reduced dummy argument list is the full dummy argument list or, if there is a passed-object dummy argument, the dummy argument list with the passed object dummy argument omitted. When there is no argument keyword, an actual argument is associated with the dummy argument that occupies the corresponding position in the reduced dummy argument list. The first actual argument becomes associated with the first dummy argument in the reduced list, the second actual argument with the second dummy argument, continuing until reaching the end of the list. Each actual argument must be associated with a dummy argument.

---

### End of Fortran 2003

When a keyword is present, the actual argument is associated with the dummy argument whose name is the same as the argument keyword. In the scoping unit that contains the procedure reference, the names of the dummy arguments must exist in an accessible explicit interface.

Argument association within a subprogram terminates upon execution of a **RETURN** or **END** statement in the subprogram. There is no retention of argument association between one reference of a subprogram and the next reference of the subprogram, unless you specify **-qxlf77=persistent** and the subprogram contains at least one entry procedure.

If associated with a null argument in a procedure reference, the corresponding dummy argument is undefined and undefinable.

---

### IBM Extension

Except when **%VAL** or the **VALUE** attribute is used, the subprogram reserves no storage for the dummy argument. It uses the corresponding actual argument for calculations. Therefore, the value of the actual argument changes when the dummy argument changes. If the corresponding actual argument is an expression or an array section with vector subscripts, the calling procedure reserves storage for the actual argument, and the subprogram must not define, redefine, or undefine the dummy argument.

If the actual argument is specified with **%VAL**, or the corresponding dummy argument has the **VALUE** attribute, the subprogram does not have access to the storage area of the actual argument.

---

### End of IBM Extension

Actual arguments must agree in type and type parameters with their corresponding dummy arguments (and in shape if the dummy arguments are pointers or assumed-shape), except for two cases: a subroutine name has no type and must be associated with a dummy procedure name that is a subroutine, and an alternate return specifier has no type and must be associated with an asterisk.

Argument association can be carried through more than one level of procedure reference.

If a subprogram reference causes a dummy argument in the referenced subprogram to become associated with another dummy argument in the referenced subprogram, neither dummy argument can become defined, redefined, or undefined during that subprogram. For example, if a subroutine definition is:

```
SUBROUTINE XYZ (A,B)
```

and it is referenced by:

```
CALL XYZ (C,C)
```

the dummy arguments A and B each become associated with the same actual argument C and, therefore, with each other. Neither A nor B can be defined, redefined, or undefined during the execution of subroutine XYZ or by any procedures referenced by XYZ.

If a dummy argument becomes associated with an entity in a common block or an entity accessible through use or host association, the value of the entity must only be altered through the use of the dummy argument name, while the entity is associated with the dummy argument. If any part of a data object is defined through a dummy argument, the data object can be referenced only through that dummy argument, either before or after the definition occurs. These restrictions also apply to pointer targets.

#### IBM Extension

If you have programs that do not conform to these restrictions, using the compiler option **-qalias=nostd** may be appropriate. See the **-qalias** Option in the *XL Fortran Compiler Reference* for details.

End of IBM Extension

## %VAL and %REF

#### IBM Extension

To call subprograms written in languages other than Fortran (for example, user-written C programs, or AIX operating system routines), the actual arguments may need to be passed by a method different from the default method used by XL Fortran. The default method passes the address of the actual argument and, if it is of type character, the length. (Use the **-qnullterm** compiler option to ensure that scalar character initialization expressions are passed with terminating null strings. See **-qnullterm** in the *XL Fortran Compiler Reference* for details.)

The default passing method can be changed by using the **%VAL** and **%REF** built-in functions in the argument list of a **CALL** statement or function reference, or with the dummy arguments in interface bodies. These built-in functions specify the way an actual argument is passed to the external subprogram.

**%VAL** and **%REF** built-in functions cannot be used in the argument lists of Fortran procedure references, nor can they be used with alternate return specifiers.

The argument list built-in functions are:

**%VAL** This built-in function can be used with actual arguments that are

**CHARACTER(1)**, logical, integer, real, complex expressions, or sequence derived type. Objects of derived type cannot contain character structure components whose lengths are greater than 1 byte, or arrays.

**%VAL** cannot be used with actual arguments that are arrays, derived types with allocatable components, procedure names, or character expressions of length greater than 1 byte.

**%VAL** causes the actual argument to be passed as 32-bit or 64-bit intermediate values. If the actual argument is of type real or complex, it is passed as one or more 64-bit intermediate values. If the actual argument is of integer, logical, or sequence derived type, it is passed as one or more 32-bit intermediate values. An integer actual argument shorter than 32 bits is sign-extended to a 32-bit value, while a logical actual argument shorter than 32 bits is padded with zeros to a 32-bit value.

Byte named constants and variables are passed as if they were **INTEGER(1)**. If the actual argument is a **CHARACTER(1)**, it is padded on the left with zeros to a 32-bit value, regardless of whether the **-qctyp1ss** compiler option is specified.

**%REF** This built-in function causes the actual argument to be passed by reference; that is, only the address of the actual argument is passed. Unlike the default passing method, **%REF** does not pass the length of a character argument. If such a character argument is being passed to a C routine, the string must be terminated with a null character (for example, using the **-qnullterm** option) so that the C routine can determine the length of the string.

### Examples of %VAL and %REF

```
EXTERNAL FUNC
CALL RIGHT2(%REF(FUNC))      ! procedure name passed by reference
REAL XVAR
CALL RIGHT3(%VAL(XVAR))     ! real argument passed by value

IVARB=6
CALL TPROG(%VAL(IVARB))     ! integer argument passed by value
```

See “VALUE” on page 472 for a standard-conforming alternative to **%VAL**.

See **Interlanguage calls** in the *XL Fortran Optimization and Programming Guide* for more information.

End of IBM Extension

## Intent of dummy arguments

With the **INTENT** attribute, you can explicitly specify the intended use of a dummy argument. Use of this attribute may improve optimization of the program’s calling procedure when an explicit interface exists. Also, the explicitness of argument intent may provide more opportunities for error checking. See “**INTENT**” on page 387 for syntax details.

IBM Extension

The following table outlines XL Fortran’s passing method for internal procedures (not including assumed-shape dummy arguments and pointer dummy arguments):

Table 18. Passing method and intent

Argument Type	Intent(IN)	Intent(OUT)	Intent(INOUT)	No Intent
Non-CHARACTER Scalar	VALUE	default	default	default
CHARACTER*1 Scalar	VALUE	REFERENCE	REFERENCE	REFERENCE
CHARACTER*n Scalar	REFERENCE	REFERENCE	REFERENCE	REFERENCE
CHARACTER*(*) Scalar	default	default	default	default
Derived Type <sup>1</sup> Scalar	VALUE	default	default	default
Derived Type <sup>2</sup> Scalar	default	default	default	default
Non-CHARACTER Array	default	default	default	default
CHARACTER*1 Array	REFERENCE	REFERENCE	REFERENCE	REFERENCE
CHARACTER*n Array	REFERENCE	REFERENCE	REFERENCE	REFERENCE
CHARACTER*(*) Array	default	default	default	default
Derived Type <sup>3</sup> Array	default	default	default	default

End of IBM Extension

## Optional dummy arguments

The **OPTIONAL** attribute specifies that a dummy argument need not be associated with an actual argument in a reference to a procedure. Some advantages of the **OPTIONAL** attribute include:

- The use of optional dummy arguments to override default behavior. For an example, see “Example of argument keywords” on page 181.
- Additional flexibility in procedure references. For example, a procedure could include optional arguments for error handlers or return codes, but you can select which procedure references would supply the corresponding actual arguments.

See “OPTIONAL” on page 407 for details about syntax and rules.

## The passed-object dummy argument

Fortran 2003

In a reference to a procedure that has a passed-object dummy argument, the *data\_ref* of the function reference or call statement is associated, as an actual argument, with the passed object dummy argument. See “Passed-object dummy arguments” on page 60

End of Fortran 2003

## Restrictions on optional dummy arguments not present

A dummy argument is present in an instance of a subprogram if it is associated with an actual argument, and the actual argument is either a dummy argument that is not optional in the invoking subprogram or a dummy argument that is not present in the invoking subprogram. A dummy argument that is not optional must be present.

1. A data object of derived type with no array components or CHARACTER\*n components, where  $n > 1$ .
2. A data object of derived type with array components or CHARACTER\*n components, where  $n > 1$ .
3. A data object of derived-type with components of any type, size and rank.

An optional dummy argument that is not present must conform to the following rules:

- If it is a dummy data object, it must not be referenced or defined. If the dummy data object is of a type for which default initialization can be specified, the initialization has no effect.
- It must not be used as the `data_target` or `proc_target` of a pointer assignment
- If it is a procedure or procedure pointer, it must not be invoked.
- It must not be supplied as an actual argument that corresponds to a nonoptional dummy argument, except as the argument of the **PRESENT** intrinsic function.
- A subobject of an optional dummy argument that is not present must not be supplied as an actual argument that corresponds to an optional dummy argument.
- If the optional dummy argument that is not present is an array, it must not be supplied as an actual argument to an elemental procedure unless an array of the same rank is supplied as an actual argument that corresponds to a nonoptional dummy argument of that elemental procedure.
- If the optional dummy argument that is not present is a pointer, it must not be allocated, deallocated, nullified, pointer-assigned or supplied as an actual argument that corresponds to a nonpointer dummy argument, except as the argument of the **PRESENT** intrinsic function.
- If the optional dummy argument that is not present is allocatable, it must not be allocated, deallocated, or supplied as an actual argument corresponding to a nonallocatable dummy argument other than as the argument of the **PRESENT** intrinsic function.
- If it has length type parameters, they must not be the subject of an inquiry.

Fortran 2003

- An optional dummy argument that is not present must not be used as the *selector* in an **ASSOCIATE** or **SELECT TYPE** construct.

End of Fortran 2003

## Length of character arguments

If the length of a character dummy argument is a nonconstant specification expression or is a colon, the object is a dummy argument with a run-time length. A character dummy argument with a colon length is a deferred length character dummy argument. If an object that is not a dummy argument has a run-time length and is not deferred length, it is an automatic object. See “Automatic objects” on page 18 for details.

If a dummy argument has a length specifier of an asterisk in parentheses, the length of the dummy argument is “inherited” from the actual argument. The length is inherited because it is specified outside the program unit containing the dummy argument. If the associated actual argument is an array name, the length inherited by the dummy argument is the length of an array element in the associated actual argument array. **%REF** cannot be specified for a character dummy argument with inherited length.

## Variables as dummy arguments

### Fortran 2003

If a dummy argument is neither allocatable nor a pointer, it must be type-compatible with the associated actual argument. If a dummy argument is allocatable or a pointer, the associated actual argument is polymorphic only if the dummy argument is polymorphic, and the declared type of the actual argument is the same as the declared type of the dummy argument.

End of Fortran 2003

If the actual argument is scalar, the corresponding dummy argument must be scalar, unless the actual argument **F2003** is of type default character, of type character with the C character kind, **F2003** or is an element or substring of an element of an array that is not an assumed-shape or pointer array. If the actual argument is allocatable, the corresponding dummy argument must also be allocatable. If the procedure is referenced by a generic name or as a defined operator or defined assignment, the ranks of the actual arguments and corresponding dummy arguments must agree. A scalar dummy argument can be associated only with a scalar actual argument.

### Fortran 2003

If the procedure is nonelemental and is referenced by a generic name or as defined operator or defined assignment, the ranks of the actual arguments and corresponding dummy arguments must agree.

End of Fortran 2003

### Fortran 95

The following apply to dummy arguments used in elemental subprograms:

- All dummy arguments must be scalar, and cannot have the **F2003** **ALLOCATABLE** or **F2003** **POINTER** attribute.
- A dummy argument, or a subobject thereof, cannot be used in a specification expression, except if it is used as an argument to the **BIT\_SIZE**, **KIND**, or **LEN** intrinsic functions, or as an argument to one of the numeric inquiry intrinsic functions, see Chapter 14, "Intrinsic procedures," on page 529.
- A dummy argument cannot be an asterisk.
- A dummy argument cannot be a dummy procedure.

End of Fortran 95

### Fortran 2003

If a scalar dummy argument is of type character, its length must be less than or equal to the length of the actual argument. The dummy argument is associated with the leftmost characters of the actual argument. If the character dummy argument is an array, the length restriction applies to the entire array rather than each array element. That is, the lengths of associated array elements can vary, although the whole dummy argument array cannot be longer than the whole



actual argument array.

---

End of Fortran 2003

---

If the dummy argument is an assumed-shape array, **F2003** the rank of the actual argument must be the same as the rank of the dummy argument; **F2003** the actual argument must not be an assumed-size array or a scalar, including a designator for an array element or an array element substring.

If the dummy argument is an explicit-shape or assumed-size array, and if the actual argument is a noncharacter array, the size of the dummy argument must not exceed the size of the actual argument array. Each actual array element is associated with the corresponding dummy array element. If the actual argument is a noncharacter array element with a subscript value of *as*, the size of the dummy argument array must not exceed the size of the actual argument array + 1 - *as*. The dummy argument array element with a subscript value of *ds* becomes associated with the actual argument array element that has a subscript value of *as* + *ds* - 1.

If an actual argument is a character array, character array element, or character substring, and begins at a character storage unit *acu* of an array, character storage unit *dcu* of an associated dummy argument array becomes associated with character storage unit *acu+dcu-1* of the actual array argument.

You can define a dummy argument that is a variable name within a subprogram if the associated actual argument is a variable. You must not redefine a dummy argument that is a variable name within a subprogram if the associated actual argument is not definable.

If the actual argument is an array section with a vector subscript, the associated dummy argument cannot be defined and shall not have the **INTENT(OUT)**, **INTENT(INOUT)**, **VOLATILE**, or **F2003 ASYNCHRONOUS F2003** attributes.

If an actual argument is an array section or an assumed-shape array, and the corresponding dummy argument has either the **VOLATILE** or **F2003 ASYNCHRONOUS F2003** attribute, that dummy argument shall be an assumed-shape array.

If an actual argument is a pointer array, and the corresponding dummy argument has either the **VOLATILE** or **F2003 ASYNCHRONOUS F2003** attribute, that dummy argument shall be an assumed-shape array or a pointer array.

**F2003** Except in references to intrinsic inquiry functions, **F2003** if a nonpointer dummy argument is associated with a pointer actual argument, the actual argument must be currently associated with a target, to which the dummy argument becomes argument associated. Any restrictions on the passing method apply to the target of the actual argument.

---

Fortran 2003

---

Except in references to intrinsic inquiry functions, if the dummy argument is not allocatable and the actual argument is allocatable, the actual argument must be allocated.

If the dummy argument has the **VALUE** attribute it becomes associated with a definable anonymous data object whose initial value is that of the actual argument.

Subsequent changes to the value or definition status of the dummy argument do not affect the actual argument.

End of Fortran 2003

If the dummy argument is neither a target nor a pointer, any pointers associated with the actual argument do not become associated with the corresponding dummy argument on invocation of the procedure.

If both the dummy and actual arguments are targets, with the dummy argument being a scalar or an assumed-shape array **F2003** without the **VALUE** attribute **F2003** (and the actual argument is not an array section with a vector subscript):

1. Any pointers associated with the actual argument become associated with the corresponding dummy argument on invocation of the procedure.
2. When execution of the procedure completes, any pointers associated with the dummy argument remain associated with the actual argument.

If both the dummy and actual arguments are targets, with the dummy argument being either an explicit-shape array or an assumed-size array, while the actual argument is not an array section with a vector subscript:

1. Whether any pointers associated with the actual argument become associated with the corresponding dummy argument on invocation of the procedure is processor dependent.
2. When execution of the procedure completes, whether any pointers associated with the dummy argument remain associated with the actual argument is processor dependent.

If the dummy argument is a target and the corresponding actual argument is not a target or is an array section with a vector subscript, any pointers associated with the dummy argument become undefined when execution of the procedure completes.

Fortran 2003

If the dummy argument has the **TARGET** attribute and the **VALUE** attribute, any pointers associated with the dummy argument become undefined when execution of the procedure completes.

End of Fortran 2003

## Allocatable objects as dummy arguments

Fortran 2003

An allocatable dummy argument has an actual argument which is also allocatable associated with it. If the allocatable dummy argument is an array, the associated actual argument must also be an array.

On procedure entry, the allocation status of an allocatable dummy argument becomes that of the associated actual argument. If the dummy argument is **INTENT(OUT)** and the associated actual argument is currently allocated, the actual argument is deallocated on procedure invocation so that the dummy argument has an allocation status of not currently allocated. If the dummy argument is not **INTENT(OUT)** and the actual argument is currently allocated, the value of the dummy argument is that of the associated actual argument.

While the procedure is active, an allocatable dummy argument that does not have **INTENT(IN)** may be allocated, deallocated, defined, or become undefined. No reference to the associated actual argument is permitted via another alias if any of these events occur.

On exit from the routine, the actual argument has the allocation status of the allocatable dummy argument (there is no change, of course, if the allocatable dummy argument has **INTENT(IN)**). The usual rules apply for propagation of the value from the dummy argument to the actual argument.

Automatic deallocation of the allocatable dummy argument does not occur as a result of execution of a **RETURN** or **END** statement in the procedure of which it is a dummy argument.

**Note:** An allocatable dummy argument that has the **INTENT(IN)** attribute must not have its allocation status altered within the called procedure. The main difference between such a dummy argument and a normal dummy argument is that it might be unallocated on entry (and throughout execution of the procedure).

### Example

```
SUBROUTINE LOAD(ARRAY, FILE)
  REAL, ALLOCATABLE, INTENT(OUT) :: ARRAY(:, :, :)
  CHARACTER(LEN=*), INTENT(IN) :: FILE
  INTEGER UNIT, N1, N2, N3
  INTEGER, EXTERNAL :: GET_LUN
  UNIT = GET_LUN() ! Returns an unused unit number
  OPEN(UNIT, FILE=FILE, FORM='UNFORMATTED')
  READ(UNIT) N1, N2, N3
  ALLOCATE(ARRAY(N1, N2, N3))
  READ(UNIT) ARRAY
  CLOSE(UNIT)
END SUBROUTINE LOAD
```

End of Fortran 2003

## Pointers as dummy arguments

If a dummy argument is a pointer, the actual argument must be a pointer and their types, type parameters, and ranks must match. The actual argument reference is to the pointer itself, not to its target. When the procedure is invoked:

- The dummy argument acquires the pointer association status of the actual argument.
- If the actual argument is associated, the dummy argument is associated with the same target.

The association status can change during execution of the procedure. When the procedure finishes executing, the dummy argument's association status becomes undefined, if it is associated.

### IBM Extension

The passing method must be by reference; that is, **%VAL** must not be specified for the pointer actual argument.

End of IBM Extension

## Procedures as dummy arguments

A dummy argument that is identified as a procedure `F2003` or a procedure pointer `F2003` is called a dummy procedure or `F2003` dummy procedure pointer, `F2003` respectively.

### Fortran 2003

If a dummy argument is a dummy procedure without the `POINTER` attribute, the associated actual argument must be the specific name of an external procedure, module procedure, dummy procedure, or intrinsic procedure whose name can be passed as an argument, an associated procedure pointer, or a reference to a function that returns an associated procedure pointer. If the specific name is also a generic name, only the specific procedure is associated with the dummy argument.

If a dummy argument is a procedure pointer, the associated actual argument must be a procedure pointer, a reference to a function that returns a procedure pointer, or a reference to the `NULL` intrinsic function.

### End of Fortran 2003

If an external procedure name or a dummy procedure name is used as an actual argument, its interface must be explicit or it must be explicitly declared with the `EXTERNAL` attribute.

If the interface of the dummy argument is explicit, the characteristics must be the same for the associated actual argument and the corresponding dummy argument, except that a pure actual argument may be associated with a dummy argument that is not pure.

If the interface of the dummy argument is implicit and either the name of the dummy argument is explicitly typed or it is referenced as a function, the dummy argument must not be referenced as a subroutine and the actual argument must be a function, `F2003` function procedure pointer `F2003`, or dummy procedure.

If the interface of the dummy argument is implicit and a reference to it appears as a subroutine reference, the actual argument must be a subroutine, `F2003` subroutine procedure pointer `F2003`, or dummy procedure.

Internal subprograms cannot be associated with a dummy procedure argument. You cannot use a non-intrinsic elemental procedure as an actual argument in Fortran 95.

## Examples of procedures as dummy arguments

```
PROGRAM MYPROG
INTERFACE
  SUBROUTINE SUB (ARG1)
    EXTERNAL ARG1
    INTEGER ARG1
  END SUBROUTINE SUB
END INTERFACE
EXTERNAL IFUNC, RFUNC
REAL RFUNC

CALL SUB (IFUNC)    ! Valid reference
CALL SUB (RFUNC)    ! Invalid reference
!
! The first reference to SUB is valid because IFUNC becomes an
! implicitly declared integer, which then matches the explicit
```

```

! interface. The second reference is invalid because RFUNC is
! explicitly declared real, which does not match the explicit
! interface.
END PROGRAM

SUBROUTINE ROOTS
  EXTERNAL NEG
  X = QUAD(A,B,C,NEG)
  RETURN
END
FUNCTION QUAD(A,B,C,FUNCT)
  INTEGER FUNCT
  VAL = FUNCT(A,B,C)
  RETURN
END

FUNCTION NEG(A,B,C)
  RETURN
END

```

### Related information

- See Chapter 14, “Intrinsic procedures,” on page 529 for details on which intrinsic procedures can be passed as actual arguments.
- See “Procedure references” on page 177 for the rules and restrictions for referencing a procedure.

## Asterisks as dummy arguments

A dummy argument that is an asterisk can only appear in the dummy argument list of a **SUBROUTINE** statement or an **ENTRY** statement in a subroutine subprogram. The corresponding actual argument must be an alternate return specifier, which indicates the statement label of a branch target statement in the same scope as the **CALL** statement, to which control is returned.

### Example of an alternate return specifier

```

      CALL SUB(*10)
      STOP                ! STOP is never executed
10 PRINT *, 'RETURN 1'
      CONTAINS
      SUBROUTINE SUB(*)
          ...
          RETURN 1        ! Control returns to statement with label 10
      END SUBROUTINE
END

```

---

## Resolution of procedure references

The subprogram name in a procedure reference is either established to be generic, established to be only specific, or not established.

A subprogram name is established to be generic in a scoping unit if one or more of the following is true:

- The scoping unit has an interface block with that name.
- The name of the subprogram is the same as the name of a generic intrinsic procedure that is specified in the scoping unit with the **INTRINSIC** attribute.
- The scoping unit accesses the generic name from a module through use association.
- There are no declarations of the subprogram name in the scoping unit, but the name is established to be generic in the host scoping unit.

A subprogram name is established to be only specific in a scoping unit when it has not been established to be generic and one of the following is true:

- An interface body in the scoping unit has the same name.
- There is a statement function, module procedure, or an internal subprogram in the scoping unit that has the same name.
- The name of the subprogram is the same as the name of a specific intrinsic procedure that is specified with the **INTRINSIC** attribute in the scoping unit.
- The scoping unit contains an **EXTERNAL** statement with the subprogram name.
- The scoping unit accesses the specific name from a module through use association.
- There are no declarations of the subprogram name in the scoping unit, but the name is established to be specific in the host scoping unit.

If a subprogram name is not established to be either generic nor specific, it is not established.

## Rules for resolving procedure references to names

The following rules are used to resolve a procedure reference to a name established to be generic:

1. If there is an interface block with that name in the scoping unit or accessible through use association, and the reference is consistent with a non-elemental reference to one of the specific interfaces of that interface block, the reference is to the specific procedure associated with the specific interface.
2. If rule 1 does not apply, there is an interface block with that name in the scoping unit or accessible through use association, and the reference is consistent with an elemental reference to one of the specific interfaces of that interface block, the reference is to the specific elemental procedure associated with the specific interface.
3. If neither Rule 1 nor Rule 2 applies, the reference is to an intrinsic procedure if the procedure name in the scoping unit is specified with the **INTRINSIC** attribute or accesses a module entity whose name is specified with the **INTRINSIC** attribute, and the reference is consistent with the interface of that intrinsic procedure.
4. If Rule 1, Rule 2 and Rule 3 do not apply, but the name is established to be generic in the host scoping unit, the name is resolved by applying the rules to the host scoping unit. For this rule to apply, there must be agreement between the host scoping unit and the scoping unit of which the name is either a function or a subroutine.

The following rules are used to resolve a procedure reference to a name established to be only specific:

1. If the scoping unit is a subprogram, and it contains either an interface body with that name or the name has the **EXTERNAL** attribute, and if the name is a dummy argument of that subprogram, the dummy argument is a dummy procedure. The reference is to that dummy procedure.
2. If Rule 1 does not apply, and the scoping unit contains either an interface body with that name or the name has the **EXTERNAL** attribute, the reference is to an external subprogram.
3. In the scoping unit, if a statement function or internal subprogram has that name, the reference is to that procedure.
4. In the scoping unit, if the name has the **INTRINSIC** attribute, the reference is to the intrinsic procedure with that name.

5. The scoping unit contains a reference to a name that is the name of a module procedure that is accessed through use association. Because of possible renaming in the **USE** statement, the name of the reference may differ from the original procedure name.
6. If none of these rules apply, the reference is resolved by applying these rules to the host scoping unit.

The following rules are used to resolve a procedure reference to a name that is not established:

1. If the scoping unit is a subprogram and if the name is the name of a dummy argument of that subprogram, the dummy argument is a dummy procedure. The reference is to that dummy procedure.
2. If Rule 1 does not apply, and the name is the name of an intrinsic procedure, the reference is to that intrinsic procedure. For this rule to apply, there must be agreement between the intrinsic procedure definition and the reference that the name is either a function or subroutine.
3. If neither Rule 1 nor 2 applies, the reference is to the external procedure with that name.

---

## Recursion

A procedure that can reference itself, directly or indirectly, is called a recursive procedure. Such a procedure can reference itself indefinitely until a specific condition is met. For example, you can determine the factorial of the positive integer N as follows:

```

INTEGER N, RESULT
READ (5,*) N
IF (N.GE.0) THEN
  RESULT = FACTORIAL(N)
END IF
CONTAINS
  RECURSIVE FUNCTION FACTORIAL (N) RESULT (RES)
    INTEGER RES
    IF (N.EQ.0) THEN
      RES = 1
    ELSE
      RES = N * FACTORIAL(N-1)
    END IF
  END FUNCTION FACTORIAL
END

```

For details on syntax and rules, see “FUNCTION” on page 362, “SUBROUTINE” on page 453, or “ENTRY” on page 343.

---

### IBM Extension

---

You can also call external procedures recursively when you specify the **-qrecur** compiler option, although XL Fortran disregards this option if the procedure specifies either the **RECURSIVE** or **RESULT** keyword.

---

End of IBM Extension

---

---

## Pure procedures

---

### Fortran 95

---

Pure procedures are free of side effects and are particularly useful in **FORALL** statements and constructs, which by design require that all referenced procedures be free of side effects.

A procedure must be pure in the following contexts:

- An internal procedure of a pure procedure
- A procedure referenced in the *scalar\_mask\_expr* or body of a **FORALL** statement or construct, including one referenced by a defined operator, defined assignment, or finalization
- A procedure referenced in a pure procedure
- A procedure actual argument to a pure procedure

Intrinsic functions (except **RAND**, an XL Fortran extension) and the **MOVE\_ALLOC** and **MVBITS** subroutines are always pure. They do not need to be explicitly declared to be pure. A statement function is pure if and only if all functions that it references are pure.

The *specification\_part* of a pure function must specify that all dummy arguments have an **INTENT(IN)**, except procedure arguments, and arguments with the **POINTER** attribute. The *specification\_part* of a pure subroutine must specify the intents of all dummy arguments, except for procedure arguments, asterisks, and arguments that have the **POINTER** attribute. Any interface body for such pure procedures must similarly specify the intents of its dummy arguments.

The *execution\_part* and *internal\_subprogram\_part* of a pure procedure cannot refer to a dummy argument with an **INTENT(IN)**, a global variable (or any object that is storage associated with one), or any subobject thereof, in contexts that may cause its value to change: that is, in contexts that produce side effects. The *execution\_part* and *internal\_subprogram\_part* of a pure function must not use a dummy argument, a global variable, or an object that is associated with a global variable, or a subobject thereof, in the following contexts:

- As *variable* in an assignment statement, or as *expression* in an assignment statement if *variable* is of a derived type that has a pointer component at any level
- As *pointer\_object* or *target* in a pointer assignment statement
- As a **DO** or implied-**DO** variable
- As an *input\_item* in a **READ** statement
- As an internal file identifier in a **WRITE** statement
- As an **IOSTAT=**, **SIZE=** or **IOMSG=** specifier variable in an input/output statement
- As a variable in an **ALLOCATE**, **DEALLOCATE**, **NULLIFY**, or **ASSIGN** statement
- As an actual argument that is associated with a dummy argument with the **POINTER** attribute or with an intent of **OUT** or **INOUT**
- As the argument to **LOC**
- As a **STAT=** or **ERRMSG=** specifier
- As a variable in a **NAMelist** which appears in a **READ** statement



- A variable that is the selector in a **SELECT TYPE** or **ASSOCIATE** construct if the associate name of that construct appears in a variable definition context.

A pure procedure must not specify that any entity is **VOLATILE**. In addition, it must not contain any references to data that is **VOLATILE**, that would otherwise be accessible through use- or host-association. This includes references to data which occur through **NAMelist I/O**.

Only internal input/output is permitted in pure procedures. Therefore, the unit identifier of an input/output statement must not be an asterisk (\*) or refer to an external unit. The input/output statements are:

- **BACKSPACE**
- **CLOSE**
- **ENDFILE**
- **F2003** **FLUSH** **F2003**
- **INQUIRE**
- **OPEN**
- **PRINT**
- **READ**
- **REWIND**
- **WAIT**
- **WRITE**

The **PAUSE** and **STOP** statements are not permitted in pure procedures.

There are two differences between pure functions and pure subroutines:

1. Subroutine nonpointer dummy data objects may have any intent, while function nonpointer dummy data objects must be **INTENT(IN)**.
2. Subroutine dummy data objects with the **POINTER** attribute can change association status and/or definition status

If a procedure is not defined as pure, it must not be declared pure in an interface body. However, the converse is not true: if a procedure is defined as pure, it does not need to be declared pure in an interface body. Of course, if an interface body does not declare that a procedure is pure, that procedure (when referenced through that explicit interface) cannot be used as a reference where only pure procedure references are permitted (for example, in a **FORALL** statement).

## Examples

```
PROGRAM ADD
  INTEGER ARRAY(20,256)
  INTERFACE
    PURE FUNCTION PLUS_X(ARRAY)
      INTEGER, INTENT(IN) :: ARRAY(:)
      INTEGER :: PLUS_X(SIZE(ARRAY))
    END FUNCTION
  END INTERFACE
  INTEGER :: X
  X = ABS(-4)
  ! Intrinsic function
  ! is always pure

  FORALL (I=1:20, I /= 10)
    ARRAY(I,:) = I + PLUS_X(ARRAY(I,:))
  ! Procedure references in
  ! FORALL must be pure

  END FORALL
END PROGRAM
```

```

PURE FUNCTION PLUS_X(ARRAY)
  INTEGER, INTENT(IN) :: ARRAY(:)
  INTEGER :: PLUS_X(SIZE(ARRAY)),X
  INTERFACE
    PURE SUBROUTINE PLUS_Y(ARRAY)
      INTEGER, INTENT(INOUT) :: ARRAY(:)
    END SUBROUTINE
  END INTERFACE
  X=8
  PLUS_X = ARRAY+X
  CALL PLUS_Y(PLUS_X)
END FUNCTION

PURE SUBROUTINE PLUS_Y(ARRAY)
  INTEGER, INTENT(INOUT) :: ARRAY(:)    ! Intent must be specified
  INTEGER :: Y
  Y=6
  ARRAY = ARRAY+Y
END SUBROUTINE

```

---

End of Fortran 95

---

## Elemental Procedures

---

### Fortran 95

---

An elemental subprogram definition must have the **ELEMENTAL** prefix specifier. If the **ELEMENTAL** prefix specifier is used, the **RECURSIVE** specifier cannot be used.

You cannot use the **-qrecur** option when specifying elemental procedures.

An elemental subprogram is a pure subprogram. However, pure subprograms are not necessarily elemental subprograms. For elemental subprograms, it is not necessary to specify both the **ELEMENTAL** prefix specifier and the **PURE** prefix specifier; the **PURE** prefix specifier is implied by the presence of the **ELEMENTAL** prefix specifier. A standard conforming subprogram definition or interface body can have both the **PURE** and **ELEMENTAL** prefix specifiers.

Elemental procedures, subprograms, and user-defined elemental procedures must conform to the following rules:

- The result of an elemental function must be a scalar, and must not have the **F2003** **ALLOCATABLE** or **F2003** **POINTER** attribute.
- The following apply to dummy arguments used in elemental subprograms:
  - All dummy arguments must be scalar, and must not have the **F2003** **ALLOCATABLE** or **F2003** **POINTER** attribute.
  - A dummy argument, or a subobject thereof, cannot be used in a specification expression, except if it is used as an argument to the **BIT\_SIZE**, **KIND**, or **LEN** intrinsic functions, or as an argument to one of the numeric inquiry intrinsic functions, see Chapter 14, “Intrinsic procedures,” on page 529.
  - A dummy argument cannot be an asterisk.
  - A dummy argument cannot be a dummy procedure.
- Elemental subprograms must follow all of the rules that apply to pure subprograms, defined in “Pure procedures” on page 196.

- Elemental subprograms can have **ENTRY** statements, but the **ENTRY** statement cannot have the **ELEMENTAL** prefix. The procedure defined by the **ENTRY** statement is elemental if the **ELEMENTAL** prefix is specified in the **SUBROUTINE** or **FUNCTION** statement.
- Elemental procedures can be used as defined operators in elemental expressions, but they must follow the rules for elemental expressions as described in “Operators and expressions” on page 98.

A reference to an elemental procedure is elemental only if:

- The reference is to an elemental function, one or more of the actual arguments is an array, and all array actual arguments have the same shape; or
- The reference is to an elemental subroutine, and all actual arguments that correspond to the **INTENT(OUT)** and **INTENT(INOUT)** dummy arguments are arrays that have the same shape. The remaining actual arguments are conformable with them.

A reference to an elemental subprogram is not elemental if all of its arguments are scalar.

The actual arguments in a reference to an elemental procedure can be either of the following:

- All scalar. For elemental functions, if the arguments are all scalar, the result is scalar.
- One or more array-valued. The following rules apply if one or more of the arguments is array-valued:
  - For elemental functions, the shape of the result is the same as the shape of the array actual argument with the greatest rank. If more than one argument appears then all actual arguments must be conformable.
  - For elemental subroutines, all actual arguments associated with **INTENT(OUT)** and **INTENT(INOUT)** dummy arguments must be arrays of the same shape, and the remaining actual arguments must be conformable with them.

For elemental references, the resulting values of the elements are the same as would be obtained if the subroutine or function had been applied separately in any order to the corresponding elements of each array actual argument.

If the intrinsic subroutine **MVBITS** is used, the arguments that correspond to the **TO** and **FROM** dummy arguments may be the same variable. Apart from this, the actual arguments in a reference to an elemental subroutine or elemental function must satisfy the restrictions described in “Argument association” on page 183.

Special rules apply to generic procedures that have an elemental specific procedure. See “Rules for resolving procedure references to names” on page 194

## Examples

### Example 1:

```
! Example of an elemental function
PROGRAM P
INTERFACE
  ELEMENTAL REAL FUNCTION LOGN(X,N)
    REAL, INTENT(IN) :: X
    INTEGER, INTENT(IN) :: N
  END FUNCTION LOGN
END INTERFACE
```

```

REAL RES(100), VAL(100,100)
...
DO I=1,100
  RES(I) = MAXVAL( LOGN(VAL(I,:),2) )
END DO
...
END PROGRAM P

```

**Example 2:**

! Elemental procedure declared with a generic interface  
INTERFACE RAND

```

  ELEMENTAL FUNCTION SCALAR_RAND(x)
    REAL, INTENT(IN) :: X
  END FUNCTION SCALAR_RAND

```

```

  FUNCTION VECTOR_RANDOM(x)
    REAL X(:)
    REAL VECTOR_RANDOM(SIZE(x))
  END FUNCTION VECTOR_RANDOM
END INTERFACE RAND

```

```

REAL A(10,10), AA(10,10)

```

! The actual argument *AA* is a two-dimensional array. The procedure  
! taking *AA* as an argument is not declared in the interface block.  
! The specific procedure *SCALAR\_RAND* is then called.

```

A = RAND(AA)

```

! The actual argument is a one-dimensional array section. The procedure  
! taking a one-dimensional array as an argument is declared in the  
! interface block. The specific procedure *VECTOR\_RANDOM* is then called.  
! This is a non-elemental reference since *VECTOR\_RANDOM* is not elemental.

```

A(:,1) = RAND(AA(6:10,2))
END

```

---

End of Fortran 95

---

## Chapter 9. XL Fortran Input/Output

XL Fortran supports both synchronous and asynchronous input/output (I/O). Synchronous I/O halts an executing application until I/O operations complete. Asynchronous I/O allows an application to continue processing while I/O operations occur in the background. Both I/O types support the following file access methods:

- Sequential access
- Direct access
- **F2003** Stream access **F2003**

Each method of access offers benefits and limitations based on the I/O concepts of, Records, Files and Units.

This section also provides explanations of the **IOSTAT=** specifier codes that can result when using XL Fortran I/O statements.

---

### Records

A record contains a sequence of characters or values. XL Fortran supports three record types:

- formatted
- unformatted
- endfile

#### Formatted records

A formatted record consists of a sequence of ASCII characters that can print in a readable format. Reading a formatted record converts the data values from readable characters into an internal representation. Writing a formatted record converts the data from the internal representation into characters.

---

#### IBM Extension

---

When printing a file with formatted records using the AIX **asa** command, the first character of each record determines vertical spacing and does not print. See *Printing Output Files with Fortran ASA Carriage Controls (asa)* in the *XL Fortran Compiler Reference* for details. The remaining characters of the record begin printing at the left margin. You can specify vertical spacing in a format specification as literal data according to the following table:

First Character of Record	Vertical Spacing Before Printing
Blank	One line
0	Two lines
1	To first line of next page
+	No advance

An error occurs if you use any other character as the first character of the print record. If the print record contains no characters, spacing advances by one line and a blank line prints. Displaying records on a terminal also uses the first character of the record, but only the characters *blank*, *0*, and *+* produce the spacing shown. You must use the AIX **asa** to display these print codes on a terminal. See *Printing*

*Output Files with Fortran ASA Carriage Controls (asa) in the XL Fortran Compiler Reference for details.)*

End of IBM Extension

## Unformatted records

An unformatted record contains a sequence of values in an internal representation that can contain both character and noncharacter data. An unformatted record can also contain no data. Reading or writing an unformatted record does not convert any data the record contains from the internal representation.

## Endfile records



If it exists, an endfile record is the last record of a file. It has no length. It can be written explicitly by an **ENDFILE** statement. It can be written implicitly to a file connected for sequential access when the last data transfer statement was a **WRITE** statement, no intervening file positioning statement referring to the file has been executed, and the following is true:

- A **REWIND** or **BACKSPACE** statement references the unit to which the file is connected; or
- The file is closed, either explicitly by a **CLOSE** statement, implicitly by a program termination not caused by an error condition, or implicitly by another **OPEN** statement for the same unit.

---

## Files

A file is an internal or external sequence of records or file storage units. You determine the file access method when connecting a file to a unit. You can access an external file using three methods:

- Sequential access
- Direct access
-  **F2003** Stream access  **F2003**

You can only access an internal file sequentially.

## Definition of an external file

You must associate an external file with an I/O device such as a disk, or terminal. An external file exists for a program when a program creates that file, or the file is available to that program for reading and writing. Deleting an external file ends the existence of that file. An external file can exist and contain no records.

IBM Extension

To specify an external file by a file name, you must designate a valid operating system file name. Each file name can contain a maximum of 255 characters. If you specify a full path name, it can contain a maximum of 1023 characters.

End of IBM Extension

The preceding I/O statement determines the position of an external file. You can position an external file to:

- The initial point, which is the position immediately before the first record, or the first file storage unit.

- The terminal point, which is the position immediately after the last record, or the last file storage unit.
- The current record, when the file position is within a record. Otherwise, there is no current record.
- The preceding record, which is the record immediately before the current record. If there is no current record, the preceding record is the record immediately before the current file position. A preceding record does not exist when the file position is at its initial point or within the first record of the file.
- The next record, which is the record immediately after the current record. If there is no current record, the next record is the record immediately after the current position. The next record does not exist when the file position is at the terminal point or within the last record of the file.

An external file can also have indeterminate position after an error.

## File access methods

### Sequential access

Using sequential access, records in a file are read or written based on the logical order of records in that file. Sequential access supports both internal and external files.

**External files:** A file connected for sequential access contains records in the order they were written. The records must be either all formatted or all unformatted; the last record of the file must be an endfile record. The records must not be read or written by direct `F2003` or stream access `F2003` I/O statements during the time the file is connected for sequential access.

**Internal files:** An internal file is a character variable that is not an array section with a vector subscript. You do not need to create internal files. They always exist, and are available to the application.

If an internal file is a scalar character variable, the file consists of one record with a length equal to that of the scalar variable. If an internal file is a character array, each element of the array is a record of the file, with each record having the same length.

An internal file must contain only formatted records. **READ** and **WRITE** are the only statements that can specify an internal file. If a **WRITE** statement writes less than an entire record, blanks fill the remainder of that record.

Fortran 2003

An internal file is positioned at the beginning of the first record prior to data transfer, except for child data transfer statements. This record becomes the current record.

End of Fortran 2003

### Direct access

Using direct access, the records of an external file can be read or written in any order. The records must be either all formatted or all unformatted. The records must not be read or written using sequential or stream access, list-directed or namelist formatting, or a nonadvancing input/output statement. If the file was

previously connected for sequential access, the last record of the file is an endfile record. The endfile record is not considered a part of the file connected for direct access.

Each record in a file connected for direct access has a record number that identifies its order in the file. The record number is an integer value that must be specified when the record is read or written. Records are numbered sequentially. The first record is number 1. Records need not be read or written in the order of their record numbers. For example, records 9, 5, and 11 can be written in that order without writing the intermediate records.

All records in a file connected for direct access must have the same length, which is specified in the **OPEN** statement when the file is connected.

Records in a file connected for direct access cannot be deleted, but they can be rewritten with a new value. A record cannot be read unless it has first been written.

## Stream access

---

### Fortran 2003

---

You can connect external files for stream access as either formatted or unformatted. Both forms use external stream files composed of one byte file storage units. While a file connected for unformatted stream access has only a stream structure, files connected for formatted stream access have both a record and a stream structure. These dual structure files have the following characteristics:

- Some file storage units represent record markers.
- The record structure is inferred from the record markers stored in the file.
- There is no theoretical limit on record length.
- Writing an empty record without a record marker has no effect.
- If there is no record marker at the end of a file, the final record is incomplete but not empty.
- The endfile record in a file previously connected for sequential access is not considered part of the file when you connect that file for stream access.

The first file storage unit of a file connected for formatted stream access has a position of 1. The position of each subsequent storage unit is greater than the storage unit immediately before it. The positions of successive storage units are not always consecutive and positionable files need not be read or written to in order of position. To determine the position of a file storage unit connected for formatted stream access, use the **POS=** specifier of the **INQUIRE** statement. If the file can be positioned, you can use the value obtained using the **INQUIRE** statement to position that file. You read from the file while connected to the file, as long as the storage unit has been written to since file creation and that the connection permits a **READ** statement. File storage units of a file connected for formatted stream access can only be read or written by formatted stream access input/output statements.

The first file storage unit of a file connected for unformatted stream access has a position of 1. The position value of successive storage units is incrementally one greater than the storage unit it follows. Positionable files need not be read or written to in order of position. Any storage unit can be read from the file while connected to the file, if the storage unit has been written to since file creation and that the connection permits a **READ** statement. File storage units of a file



connected for unformatted stream access can only be read or written by stream access input/output statements.

End of Fortran 2003



## Units

A unit is a means of referring to a file. Programs refer to files by the unit numbers indicated by unit specifiers in input/output statements. See [UNIT=] for the form of a unit specifier.

### Connection of a unit

A connection refers to the association between a file and a unit. A connection must occur before the records of a file can be read or written.

There are three ways to connect a file to a unit:

- Preconnection
-  Implicit connection 
- Explicit connection, using the **OPEN** statement

#### Preconnection

Preconnection occurs when the program begins executing. You can specify preconnection in I/O statements without the prior execution of an **OPEN** statement.

#### IBM Extension

Using formatted sequential access always preconnects units 0, 5 and 6 as unnamed files to the devices below:

- Unit 0 to the standard error device
- Unit 5 to the standard input device
- Unit 6 to the standard output device

The other properties of these files are the default specifier values for the **OPEN** statement with the following exceptions:

- **STATUS='OLD'**
- **ACTION='READWRITE'**
- **FORM='FORMATTED'**

End of IBM Extension

#### Implicit connection

#### IBM Extension

Implicit connection occurs when a sequential statement that is; **ENDFILE**, **PRINT**, **READ**, **REWIND**, or **WRITE** executes on a unit not already connected to an external file. The executing statement connects that unit to a file with a predetermined name. By default, this connection is unit *n* to file *fort.n*. You do not need to create the file before implicit connection. To implicitly connect to a different file name, see the **UNIT\_VARS** run-time option under *Setting Run-Time Options* in the *XL Fortran Compiler Reference*.

You can not specify unit 0 for implicit connection.

You can only connect a preconnected unit implicitly if you terminate the connection between the unit and the external file. In the next example a preconnected unit closes before implicit connection takes place.

#### Sample Implicit Connection

```
PROGRAM TRYME
WRITE ( 6, 10 ) "Hello1"  ! "Hello1" written to standard output
CLOSE ( 6 )
WRITE ( 6, 10 ) "Hello2"  ! "Hello2" written to fort.6
10  FORMAT (A)
END
```

A unit with an implicit connection uses the default specifier values of the **OPEN** statement, except for the **FORM=** and **ASYNCH=** specifiers. The first data transfer statement determines the values for **FORM=** and **ASYNCH=**.

If the first I/O statement uses format-directed, list-directed, or namelist formatting, the value of the **FORM=** specifier is set to **FORMATTED**. An unformatted I/O statement sets the specifier to **UNFORMATTED**.

If the first I/O statement is asynchronous, the value of the **ASYNCH=** specifier is set to **YES**. A synchronous I/O statement sets the specifier to **NO**.

End of IBM Extension

#### Disconnection

The **CLOSE** statement disconnects a file from a unit. You can connect the file again within the same program to the same unit or to a different unit. You can connect the unit again within the same program to the same file or a different file.

#### IBM Extension

- You can not close unit 0
- You can not reconnect unit 5 to standard input after the unit closes
- You can not reconnect unit 6 to standard output after the unit closes

End of IBM Extension

---

## Data transfer statements

The **READ** statement obtains data from an external or internal file and transfers the data to internal storage. If you specify an input list, values transfer from the file to the data items you specify.

The **WRITE** statement transfers data from internal storage into an external or internal file.

The **PRINT** statement transfers data from internal storage into an external file. Specifying the **-qport=typestmt** compiler option enables the **TYPE** statement which supports functionality identical to **PRINT**. If you specify an output list and format specification, values transfer to the file from the data items you specify. If you do not specify an output list, the **PRINT** statement transfers a blank record to the output device unless the **FORMAT** statement it refers to contains, as the first specification, a character string edit descriptor or a slash edit descriptor. In this case, the records these specifications indicate transfer to the output device.

Execution of a **WRITE** or **PRINT** statement for a file that does not exist creates that file, unless an error occurs.

If an input/output item is a pointer, data is transferred between the file and the associated target.

**Fortran 2003**

A list item must not be polymorphic unless it is processed by a user-defined derived-type input/output procedure

**End of Fortran 2003**

During advancing input from a file with a **PAD=** specifier that has the value **NO**, the input list and format specification must not require more characters from the record than that record contains. If the **PAD=** specifier has the value **YES**, blank characters are supplied if the input list and format specification require more characters from the record than the record contains.

**IBM Extension**

If you want to pad files connected for sequential access, specify the **-qxlf77=noblankpad** compiler option. This compiler option also sets the default value for the **PAD=** specifier to **NO** for direct and stream files and **YES** for sequential files.

**End of IBM Extension**

During nonadvancing input from a file with a **PAD=** specifier that has the value **NO**, an end-of-record condition occurs if the input list and format specification require more characters from the record than the record contains. If the **PAD=** specifier has the value **YES**, an end-of-record condition occurs and blank characters are supplied if an input item and its corresponding data edit descriptor require more characters from the record than the record contains. If the record is the last record of a stream file, an end-of-file condition occurs.

## Asynchronous Input/Output

You can specify asynchronous **READ** and **WRITE** data transfer statements to initiate asynchronous data transfer. Execution continues after the asynchronous I/O statement, without waiting for the data transfer to complete.

Executing a matching **WAIT** statement with the same **ID=** value that was returned to the **ID=** variable in the data transfer statement detects that the data transfer statement is complete, or waits for that data transfer statement to complete.

The data transfer of an I/O item in an asynchronous I/O statement can complete:

- During the execution of the asynchronous data transfer statement
- At any time before the execution of the matching **WAIT** statement
- During the matching **WAIT** statement

For information on situations where data transfer must complete during the asynchronous data transfer statement, see *Implementation details of XL Fortran Input/Output* in the *XL Fortran Optimization and Programming Guide*.

If an error occurs during the execution of an asynchronous data transfer statement, the statement executes as if it were synchronous. The **ID=** specifier remains undefined and the accompanying **WAIT** statement does not execute. Instead of the **WAIT** statement, the **ERR=** specifier handles the error, and the **IOSTAT=** specifier indicates the status of the I/O operation.

You must not reference, define, or undefine variables or items associated with a variable appearing in an I/O list for an asynchronous data transfer statement, until the execution of the matching **WAIT** statement.

Any deallocation of allocatable objects and pointers and changing association status of pointers are disallowed between an asynchronous data transfer statement and the matching **WAIT** statement.

#### IBM Extension

Multiple outstanding asynchronous data transfer operations on the same unit must all be **READ** or all be **WRITE**. You must not specify other I/O statements on the same unit until the matching **WAIT** statements for all outstanding asynchronous data transfer operations on the same unit execute.

End of IBM Extension

#### Fortran 2003

Multiple outstanding data transfer operations on the same unit can be both **READ** and **WRITE**. A **WAIT** statement will perform a wait operation for all pending data transfers for the specified unit if the **ID=** specifier is omitted.

End of Fortran 2003

In the case of direct access, an asynchronous **WRITE** statement must not specify both the same unit and record number as any asynchronous **WRITE** statement for which the matching **WAIT** statement has not been executed. **F2003** For stream access, an asynchronous **WRITE** statement must not specify either the same unit and location within a file as any asynchronous **WRITE** statement for which the matching **WAIT** statement has not been executed. **F2003**

In the portion of the program that executes between the asynchronous data transfer statement and the matching **WAIT** statement, you must not reference, define, or undefine variables or items associated with the *integer\_variable* in the **NUM=** specifier of that data transfer statement.

#### Using Asynchronous I/O

```
SUBROUTINE COMPARE(ISTART, IEND, ISIZE, A)
  INTEGER, DIMENSION(ISIZE) :: A
  INTEGER I, ISTART, IEND, ISIZE
  DO I = ISTART, IEND
    IF (A(I) /= I) THEN
      PRINT *, "Expected ", I, ", got ", A(I)
    END IF
  END DO
END SUBROUTINE COMPARE

PROGRAM SAMPLE
  INTEGER, PARAMETER :: ISIZE = 1000000
  INTEGER, PARAMETER :: SECT1 = (ISIZE/2) - 1, SECT2 = ISIZE - 1
```

```

INTEGER, DIMENSION(ISIZE), STATIC :: A
INTEGER IDVAR

OPEN(10, STATUS="OLD", ACCESS="DIRECT", ASYNCH="YES", RECL=(ISIZE/2)*4)
A = 0

! Reads in the first part of the array.
READ(10, REC=1) A(1:SECT1)

! Starts asynchronous read of the second part of the array.
READ(10, ID=IDVAR, REC=2) A(SECT1+1:SECT2)

! While the second asynchronous read is being performed,
! do some processing here.

CALL COMPARE(1, SECT1, ISIZE, A)

WAIT(ID=IDVAR)

CALL COMPARE(SECT1+1, SECT2, ISIZE, A)
END

```

## Advancing and nonadvancing Input/Output

Advancing I/O positions the file after the last record that is read or written, unless an error condition occurs.

Nonadvancing I/O can position the file at a character position within the current record, or a subsequent record. With nonadvancing I/O, you can **READ** or **WRITE** a record of the file by a sequence of I/O statements that each access a portion of the record. You can also read variable-length records and inquire about the length of the records.

### Nonadvancing I/O

```

! Reads digits using nonadvancing input

INTEGER COUNT
CHARACTER(1) DIGIT
OPEN (7)
DO
  READ (7, FMT="(A1)", ADVANCE="NO", EOR=100) DIGIT
  COUNT = COUNT + 1
  IF ((ICCHAR(DIGIT).LT.ICCHAR('0')).OR.(ICCHAR(DIGIT).GT.ICCHAR('9')))) THEN
    PRINT *, "Invalid character ", DIGIT, " at record position ", COUNT
    STOP
  END IF
END DO
100 PRINT *, "Number of digits in record = ", COUNT
END

! When the contents of fort.7 is '1234\n', the output is:

!   Number of digits in record = 4

```

## User-defined derived-type Input/Output procedure interfaces

Fortran 2003

User-defined derived-type input/output procedures allow a program to override the default handling of derived-type objects and values in data transfer input/output statements.

A user-defined derived-type input/output procedure is a procedure accessible by a *dtio\_generic\_spec*. A particular user-defined derived-type input/output procedure is selected based on the existence of one of the following:

1. A suitable generic interface with both:
  - a. a *dtio\_generic\_spec* that is appropriate to the direction (read or write) and form (formatted or unformatted) of the data transfer, and
  - b. a specific interface whose *dtv* argument is compatible with the effective item. For more information on *dtv* see “User-defined derived-type Input/Output procedures” on page 166.
2. A suitable generic binding for the declared type of the effective item.

If a derived-type input/output procedure is selected as specified above, it is called for any appropriate data transfer input/output statements executed in that scoping unit. The procedure controls the actual data transfer operations for the derived-type list item.

A data transfer statement that includes a derived-type list item and that causes a user-defined derived-type input/output procedure to be invoked is called a parent data transfer statement. A data transfer statement that is executed while a parent data transfer statement is being processed, and that specifies the unit passed into a user-defined derived-type input/output procedure, is called a child data transfer statement.

A child data transfer statement is processed differently from a nonchild data transfer statement in the following ways:

- Executing a child data transfer statement does not position the file prior to data transfer.
- An unformatted child data transfer statement does not position the file after data transfer is complete.

End of Fortran 2003

## User-defined derived-type Input/Output

Fortran 2003

For a particular derived type and a particular set of kind type parameter values, there are four possible user-defined derived-type input/output procedures: one each for formatted input, formatted output, unformatted input, and unformatted output. You do not need to supply all four procedures. You can specify the procedures to be used for derived-type input/output by interface blocks or by generic bindings, with a *dtio\_generic\_spec* (the values for *dtio\_generic\_spec* are given in Table 17 on page 167).

While a parent data transfer statement is active, the following rules apply:

- When a parent **READ** statement is active, an input/output statement does not read from any external unit other than the one specified by the dummy argument *unit* and does not write to any external unit.
- When a parent **WRITE** or **PRINT** statement is active, an input/output statement does not write to any external unit other than the one specified by the dummy argument *unit* and does not read from any external unit.
- A data transfer statement that specifies an internal file is permitted.
- **OPEN**, **CLOSE**, **BACKSPACE**, **ENDFILE**, and **REWIND** statements are not executed.
- The user-defined procedure, and any procedures that it invokes, cannot define or undefine any storage location referenced by any input/output list item, the corresponding format, or any specifier in any active parent data transfer statement, except through the *dtv* argument.

The following are additional rules for user-defined derived-type input/output procedure data transfer statements:

- The procedure may use a **FORMAT** with a **DT** edit descriptor for handling a component of the derived type that is itself of a derived type. A child data transfer statement that is a list-directed or namelist input/output statement may contain a list item of derived type.
- Because a child data transfer statement does not position the file prior to data transfer, it starts transferring data from where the file was positioned by the parent data transfer statement's most recently processed effective list item or record positioning edit descriptor. This is not necessarily at the beginning of a record.
- A record positioning edit descriptor, such as **TL** and **TR**, used on *unit* by a child data transfer statement, does not cause the record to be positioned before its position at the time the procedure was invoked.
- Parent and child data transfer statements cannot be asynchronous.
- A child data transfer statement must not specify the **ID=**, **POS=**, or **REC=** specifiers in an input/output control list.

### Example of a derived-type Input/Output procedure

The following is an example of derived-type formatted output. The type and associated formatted write procedure are defined in a module so that they are accessible from wherever they might be needed. It would also be possible to check *iotype* and *vlist*, and to set *iomsg* and *iostat*.

```

module m
  type point
    character(20) label
    integer x, y
  contains
    procedure :: writepoint
    generic :: write(formatted) => writepoint
  end type

  type :: line
    type(point) :: p1,p2
  contains
    procedure :: writeline
    generic :: write(formatted) => writeline
  end type
  contains
    subroutine writepoint(dtv, unit, iotype, vlist, iostat, iomsg)
      class(point), intent(in) :: dtv
      integer, intent(in) :: unit
      character(*), intent(in) :: iotype
    end subroutine

```

```

        integer, intent(in) :: vlist(:)
        integer, intent(out) :: iostat
        character(*), intent(inout) :: iomsg

        write(unit, *, iostat=iostat, iomsg=iomsg) &
            trim(dtv%label), ': (', dtv%x, ', ', dtv%y, ')'
    end subroutine

    subroutine writeline(dtv, unit, iotype, vlist, iostat, iomsg)
        class(line), intent(in) :: dtv
        integer, intent(in) :: dtv
        character(*), intent(in) :: iotype
        integer, intent(in) :: vlist(:)
        integer, intent(out) :: iostat
        character(*), intent(inout) :: iomsg

        real length, delta_x, delta_y
        delta_x = dtv%p2%x - dtv%p1%x
        delta_y = dtv%p2%y - dtv%p1%y
        length = sqrt(delta_x**2 + delta_y**2)

        write(unit, *, iostat=iostat, iomsg=iomsg) &
            'Distance from ', dtv%p1, ' to ', dtv%p2, ' is ', length
    end subroutine
end module

use m
type(point) :: p = point('Point1', x=1, y=1)
type(line) :: l
l = line(p, point('Point2', x=4, y=5))
print *, l
end

```

Output:  
Distance from Point1: ( 1 , 1 ) to Point2: ( 4 , 5 ) is 5.000000000

---

End of Fortran 2003

---

## File position before and after data transfer

For an explicit connection using an **OPEN** statement for sequential or stream I/O that specifies the **POSITION=** specifier, you can position the file explicitly at the beginning, at the end, where the position is on opening.

If the **OPEN** statement does not specify the **POSITION=** specifier:

- If the **STATUS=** specifier has the value **NEW** or **SCRATCH**, the file position is at the beginning.

---

### IBM Extension

---

- If you specify **STATUS='OLD'** with the **-qposition=appendold** compiler option, and the next operation that changes the file position is a **WRITE** statement, then the file position is at the end. If these conditions are not met, the file position is at the beginning.
- If you specify **STATUS='UNKNOWN'** with the **-qposition=appendunknown** compiler option, and the next operation is a **WRITE** statement, then the file position is at the end. If these conditions are not met, the file position is at the beginning.

After an implicit **OPEN**, the file position is at the beginning:



- If the first I/O operation on the file is **PRINT** or **READ**, the application reads the first record of the file.
- If the first I/O operation on the file is **WRITE**, the application deletes the contents of the file and writes at the first record.

---

**End of IBM Extension**

---

You can use a **REWIND** statement to position a file at the beginning. The preconnected units 0, 5 and 6 are positioned as they come from the parent process of the application.

The positioning of a file prior to data transfer depends on the method of access:

- Sequential access for an external file:
  - For advancing input, the file position is at the beginning of the next record. This record becomes the current record.
  - Advancing output creates a new record and becomes the last record of the file.
- Sequential access for an internal file:
  - File position is at the beginning of the first record of the file. This record becomes the current record.
- Direct access:
  - File position is at the beginning of the record that the **REC=** specifier indicates. This record becomes the current record.
- **F2003** Stream access:
  - File position is immediately before the file storage unit the **POS=** specifier indicates. If there is no **POS=** specifier, the file position remains unchanged.

**F2003**

---

**Fortran 2003**

---

File positioning for a child data transfer statement is processed differently from a nonchild data transfer statement in the following ways:

- Executing a child data transfer statement does not position the file prior to data transfer.
- An unformatted child data transfer statement does not position the file after data transfer is complete.

---

**End of Fortran 2003**

---

After advancing I/O data transfer, the file position is:

- Beyond the endfile record if an end-of-file condition exists as a result of reading an endfile record.
- Beyond the last record read or written if no error or end-of-file condition exists. That last record becomes the preceding record. A record written on a file connected for sequential or formatted stream access becomes the last record of the file.

After nonadvancing input the file position:

- If no error condition or end-of-file condition occurs, but an end-of-record condition occurs, the file position is immediately after the record read.

- If no error condition, end-of-file condition or end-of-record condition occurs in a nonadvancing input statement, the file position does not change.
- If no error condition occurs in a nonadvancing output statement, the file position does not change.
- In all other cases, the file position is immediately after the record read or written and that record becomes the preceding record.

If the file position is beyond the endfile record, a **READ**, **WRITE**, **PRINT**, or **ENDFILE** statement can not execute if the compiler option **-qxlf77=softeof** is not set. A **BACKSPACE** or **REWIND** statement can be used to reposition the file.

IBM Extension

Use the **-qxlf77=softeof** option to be able to read and write past the end-of-file.

End of IBM Extension

Fortran 2003

For formatted stream output with no errors, the terminal point of the file is set to the highest-numbered position to which data was transferred by the statement. For unformatted stream output with no errors, the file position is unchanged. If the file position exceeds the previous terminal point of the file, the terminal point is set to the file position. Use the **POS=** specifier with an empty output list to extend the terminal point of the file without writing data. After data transfer, if an error occurs, the file position is indeterminate.

End of Fortran 2003

---

## Conditions and IOSTAT values

An IOSTAT value is a value assigned to the variable for the **IOSTAT=** specifier if end-of-file condition, end-of-record condition or an error condition occurs during an input/output statement. The **IOSTAT=** specifier reports the following types of error conditions:

- Catastrophic
- Severe
- Recoverable
- Conversion
- Language

### End-of-record conditions

When an application encounters an end-of-record condition with the **IOSTAT=** specifier, it sets the value to -4 and branches to the **EOR=** label if that label is present. If the **IOSTAT=** and **EOR=** specifiers are not present on the I/O statement when an application encounters an end-of-record condition, the application stops.

*Table 19. IOSTAT values for end-of-record conditions*

IOSTAT Value	End-of-Record Condition Description
-4	End of record encountered on a nonadvancing, format-directed READ of an internal or external file.

## End-of-file conditions

An end-of-file condition can occur in the following instances:

- At the beginning of the execution of an input statement.
- During execution of a formatted input statement that requires more than one record through the interaction of the input list and the format.
- During execution of a stream input statement.
- When encountering an endfile record while reading of a file connected for sequential access.
- When attempting to read a record beyond the end of an internal file.

**F2003** For stream access, an end-of-file condition occurs when you attempt to read beyond the end of a file. An end-of-file condition also occurs if you attempt to read beyond the last record of a stream file connected for formatted access. **F2003**

An end-of-file condition causes **IOSTAT=** to be set to one of the values defined below and branches to the **END=** label if these specifiers are present on the input statement. If the **IOSTAT=** and **END=** specifiers are not present on the input statement when an end-of-file condition is encountered, the program stops.

Table 20. *IOSTAT* values for end-of-file conditions

<b>IOSTAT Value</b>	<b>End-of-File Condition Description</b>
-1	End of file encountered on sequential or stream READ of an external file, or <b>END=</b> is specified on a direct access read and the record is nonexistent.
-1 <b>1</b>	End of file encountered on READ of an internal file.
-2	End of file encountered on READ of an internal file.

### Notes:

1. Fortran 2003 Standard. See the **IOSTAT\_END** run-time option for more information.

## Error conditions

### Catastrophic errors

Catastrophic errors are system-level errors encountered within the run-time system that prevent further execution of the program. When a catastrophic error occurs, a short (non-translated) message is written to unit 0, followed by a call to the C library routine **abort()**. A core dump can result, depending on how you configure your execution environment.

### Severe errors

A severe error cannot be recovered from, even if the **ERR\_RECOVERY** run-time option has been specified with the value **YES**. A severe error causes the **IOSTAT=** specifier to be set to one of the values defined below and the **ERR=** label to be branched to if these specifiers are present on the input/output statement. If the **IOSTAT=** and **ERR=** specifiers are not present on the input/output statement when a severe error condition is encountered, the program stops.

Table 21. IOSTAT Values for severe error conditions

IOSTAT Value	Error Description
1	END= is not specified on a direct access READ and the record is nonexistent.
2	End of file encountered on WRITE of an internal file.
6	File cannot be found and STATUS='OLD' is specified on an OPEN statement.
10	Read error on direct file.
11	Write error on direct file.
12	Read error on sequential or stream file.
13	Write error on sequential or stream file.
14	Error opening file.
15	Permanent I/O error encountered on file.
37	Dynamic memory allocation failure - out of memory.
38	REWIND error.
39	ENDFILE error.
40	BACKSPACE error.
107	File exists and STATUS='NEW' was specified on an OPEN statement.
119	BACKSPACE statement attempted on unit connected to a tape device.
122	Incomplete record encountered during direct access READ.
130	ACTION='READWRITE' specified on an OPEN statement to connect a pipe.
135	The user program is making calls to an unsupported version of the XL Fortran run-time environment.
139	I/O operation not permitted on the unit because the file was not opened with an appropriate value for the ACTION= specifier.
142	CLOSE error.
144	INQUIRE error.
152	ACCESS='DIRECT' is specified on an OPEN statement for a file that can only be accessed sequentially.
153	POSITION='REWIND' or POSITION='APPEND' is specified on an OPEN statement and the file is a pipe.
156	Invalid value for RECL= specifier on an OPEN statement.
159	External file input could not be flushed because the associated device is not seekable.
165	The record number of the next record that can be read or written is out of the range of the variable specified with the NEXTREC= specifier of the INQUIRE statement.
169	The asynchronous I/O statement cannot be completed because the unit is connected for synchronous I/O only.
172	The connection failed because the file does not allow asynchronous I/O.
173	An asynchronous READ statement was executed while asynchronous WRITE statements were pending for the same unit, or an asynchronous WRITE statement was executed while asynchronous READ statements were pending for the same unit.

Table 21. IOSTAT Values for severe error conditions (continued)

IOSTAT Value	Error Description
174	The synchronous I/O statement cannot be completed because an earlier asynchronous I/O statement has not been completed.
175	The WAIT statement cannot be completed because the value of the ID= specifier is invalid.
176	The WAIT statement cannot be completed because the corresponding asynchronous I/O statement is in a different scoping unit.
178	The asynchronous direct WRITE statement for a record is not permitted because an earlier asynchronous direct WRITE statement for the same record has not been completed.
179	The I/O operation cannot be performed on the unit because there are still incomplete asynchronous I/O operations on the unit.
181	A file cannot be connected to a unit because multiple connections are allowed for synchronous I/O only.
182	Invalid value for UWIDTH= option. It must be set to either 32 or 64.
183	The maximum record length for the unit is out of the range of the scalar variable specified with the RECL= specifier in the INQUIRE statement.
184	The number of bytes of data transmitted is out of the range of the scalar variable specified with the SIZE= or NUM= specifier in the I/O statement.
185	A file cannot be connected to two units with different UWIDTH values.
186	Unit numbers must be between 0 and 2,147,483,647.
192	The value of the file position is out of the range of the scalar variable specified with the POS= specifier in the INQUIRE statement.
193	The value of the file size is out of the range of the scalar variable specified with the SIZE= specifier in the INQUIRE statement.
200	<b>FLUSH</b> error.
201	The unit specified in the <b>FLUSH</b> statement is connected to a non-seekable file.

## Recoverable errors

A recoverable error is an error that can be recovered from. A recoverable error causes the **IOSTAT=** specifier to be set to one of the values defined below and the **ERR=** label to be branched to if these specifiers are present on the input/output statement. If the **IOSTAT=** and **ERR=** specifiers are not present on the input/output statement and the **ERR\_RECOVERY** run-time option is set to **YES**, recovery action occurs and the program continues. If the **IOSTAT=** and **ERR=** specifiers are not present on the input/output statement and the **ERR\_RECOVERY** option is set to **NO**, the program stops.

Table 22. IOSTAT values for recoverable error conditions

IOSTAT Value	Error Description
16	Value of REC= specifier invalid on direct I/O.
17	I/O statement not allowed on direct file.
18	Direct I/O statement on an unconnected unit.
19	Unformatted I/O attempted on formatted file.
20	Formatted I/O attempted on unformatted file.
21	Sequential or stream I/O attempted on direct file.

Table 22. IOSTAT values for recoverable error conditions (continued)

IOSTAT Value	Error Description
22	Direct I/O attempted on sequential or stream file.
23	Attempt to connect a file that is already connected to another unit.
24	OPEN specifiers do not match the connected file's attributes.
25	RECL= specifier omitted on an OPEN statement for a direct file.
26	RECL= specifier on an OPEN statement is negative.
27	ACCESS= specifier on an OPEN statement is invalid.
28	FORM= specifier on an OPEN statement is invalid.
29	STATUS= specifier on an OPEN statement is invalid.
30	BLANK= specifier on an OPEN statement is invalid.
31	FILE= specifier on an OPEN or INQUIRE statement is invalid.
32	STATUS='SCRATCH' and FILE= specifier specified on same OPEN statement.
33	STATUS='KEEP' specified on CLOSE statement when file was opened with STATUS='SCRATCH'.
34	Value of STATUS= specifier on CLOSE statement is invalid.
36	Invalid unit number specified in an I/O statement.
47	A namelist input item was specified with one or more components of nonzero rank.
48	A namelist input item specified a zero-sized array.
58	Format specification error.
93	I/O statement not allowed on error unit (unit 0).
110	Illegal edit descriptor used with a data item in formatted I/O.
120	The NLWIDTH setting exceeds the length of a record.
125	BLANK= specifier given on an OPEN statement for an unformatted file.
127	POSITION= specifier given on an OPEN statement for a direct file.
128	POSITION= specifier value on an OPEN statement is invalid.
129	ACTION= specifier value on an OPEN statement is invalid.
131	DELIM= specifier given on an OPEN statement for an unformatted file.
132	DELIM= specifier value on an OPEN statement is invalid.
133	PAD= specifier given on an OPEN statement for an unformatted file.
134	PAD= specifier value on an OPEN statement is invalid.
136	ADVANCE= specifier value on a READ statement is invalid.
137	ADVANCE='NO' is not specified when SIZE= is specified on a READ statement.
138	ADVANCE='NO' is not specified when EOR= is specified on a READ statement.
145	READ or WRITE attempted when file is positioned after the endfile record.
163	Multiple connections to a file located on a non-random access device are not allowed.

Table 22. IOSTAT values for recoverable error conditions (continued)









IOSTAT Value	Error Description
164	Multiple connections with ACTION='WRITE' or ACTION='READWRITE' are not allowed.
170	ASYNCH= specifier value on an OPEN statement is invalid.
171	ASYNCH= specifier given on an OPEN statement is invalid because the FORM= specifier is set to FORMATTED.
177	The unit was closed while there were still incomplete asynchronous I/O operations.
191	The RECL= specifier is specified on an OPEN statement that has ACCESS='STREAM'.
194	The BACKSPACE statement specifies a unit connected for unformatted stream I/O.
195	POS= specifier on an I/O statement is less than one.
196	 The stream I/O statement cannot be performed on the unit because the unit is not connected for stream access. 
197	POS= specifier on an I/O statement for a unit connected to a non-seekable file.
198	Stream I/O statement on an unconnected unit.
202	 The ID=, POS=, or REC= specifier is not allowed in a child READ or WRITE statement. 
203	 The child READ or WRITE statement specified a unit number which does not match the unit number of the parent statement. 
204	 The child READ or WRITE statement is not allowed because the parent statement is not a READ or WRITE statement. 
205	The user-defined derived type I/O procedure set the IOSTAT variable, but the parent statement did not specify IOSTAT=.
209	The BLANK= specifier in the READ statement has an illegal value.
210	A specifier in the READ statement has an illegal value.
211	The DELIM= specifier in the WRITE statement has an illegal value.
212	 The data item in the formatted READ or WRITE statement must be processed by a DT edit descriptor. The READ or WRITE statement is ignored. 
213	The NAMELIST item name encountered by the NAMELIST READ statement was not followed by an equals ('=')
214	The DELIM= specifier in the internal WRITE statement has an illegal value.
215	SIGN= specifier value on a WRITE statement is invalid for the external file.
216	SIGN= specifier value on a WRITE statement is invalid for the internal file.
217	SIGN= specifier given on an OPEN statement for an unformatted file.
218	SIGN= specifier value on an OPEN statement is invalid.

Table 22. IOSTAT values for recoverable error conditions (continued)

IOSTAT Value	Error Description
219	DECIMAL= specifier value is invalid for external file.
220	DECIMAL= specifier value is invalid for internal file.
221	DECIMAL= specifier is used in an unformatted I/O statement.
222	The ROUND= specifier was specified in an OPEN statement with FORM='UNFORMATTED'
223	The ROUND= specifier in the I/O statement has an illegal value.
224	There is no outstanding asynchronous data transfer specified by the ID= specifier.
225	A specifier in the OPEN statement has an illegal value.
226	There is no outstanding asynchronous data transfer specified.
227	Asynchronous data transfer error is not associated with the specified unit.
228	The UFMT_LITTLEENDIAN option was specified for a unit connected for formatted I/O.
229	The v-list of the DT edit descriptor contains an unexpected character.
230	The v-list of the DT edit descriptor contains an unexpected non-printable character.
231	Asynchronous data transfer error is not associated with the specified file.
232	OpenMP thread number is not available.
233	BACKSPACE performed on a unit that does not have read access.

## Conversion errors

A conversion error occurs as a result of invalid data or the incorrect length of data in a data transfer statement. A conversion error causes the **IOSTAT=** specifier to be set to one of the values defined below and the **ERR=** label to be branched to if these specifiers are present on the input/output statement and the **CNVERR** option is set to **YES**. If the **IOSTAT=** and **ERR=** specifiers are not present on the input/output statement, both the **CNVERR** option and the **ERR\_RECOVERY** option are set to **YES**, recovery action is performed and the program continues. If the **IOSTAT=** and **ERR=** specifiers are not present on the input/output statement, the **CNVERR** option is set to **YES**, the **ERR\_RECOVERY** option is set to **NO**, and the program stops. If **CNVERR** is set to **NO**, the **ERR=** label is never branched to but the **IOSTAT=** specifier may be set, as indicated below.

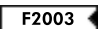
Table 23. IOSTAT values for conversion error conditions

IOSTAT Value	Error Description	IOSTAT set if CNVERR=NO
3	End of record encountered on an unformatted file.	no
4	End of record encountered on a formatted external file using advancing I/O.	no
5	End of record encountered on an internal file.	no
7	Incorrect format of list-directed input found in an external file.	yes
8	Incorrect format of list-directed input found in an internal file.	yes



Table 23. IOSTAT values for conversion error conditions (continued)

IOSTAT Value	Error Description	IOSTAT set if CNVERR=NO
9	List-directed or NAMELIST data item too long for the internal file.	yes
41	Valid logical input not found in external file.	no
42	Valid logical input not found in internal file.	no
43	Complex value expected using list-directed or NAMELIST input in external file but not found.	no
44	Complex value expected using list-directed or NAMELIST input in internal file but not found.	no
45	NAMELIST item name specified with unknown or invalid derived-type component name in NAMELIST input.	no
46	NAMELIST item name specified with an invalid substring range in NAMELIST input.	no
49	List-directed or namelist input contained an invalid delimited character string.	no
56	Invalid digit found in input for B, O or Z format edit descriptors.	no
84	NAMELIST group header not found in external file.	yes
85	NAMELIST group header not found in internal file.	yes
86	Invalid NAMELIST input value found in external file.	no
87	Invalid NAMELIST input value found in internal file.	no
88	Invalid name found in NAMELIST input.	no
90	Invalid character in NAMELIST group or item name in input.	no
91	Invalid NAMELIST input syntax.	no
92	Invalid subscript list for NAMELIST item in input.	no
94	Invalid repeat specifier for list-directed or NAMELIST input in external file.	no
95	Invalid repeat specifier for list-directed or NAMELIST input in internal file.	no
96	Integer overflow in input.	no
97	Invalid decimal digit found in input.	no
98	Input too long for B, O or Z format edit descriptors.	no
121	Output length of NAMELIST item name or NAMELIST group name is longer than the maximum record length or the output width specified by the NLWIDTH option.	yes

### Fortran 90, 95 and 2003 standard language errors

A Fortran 90 language error results from the use of XL Fortran extensions to the Fortran 90 language that cannot be detected at compile time. A Fortran 90 language error is considered a severe error when the **LANGLVL** run-time option has been specified with the value **90STD** and the **ERR\_RECOVERY** run-time option has either not been set or is set to **NO**. If both **LANGLVL=90STD** and **ERR\_RECOVERY=YES** have been specified, the error is considered a recoverable error. If **LANGLVL= EXTENDED** is specified, the error condition is not considered an error.

A Fortran 95 language error results from the use of XL Fortran extensions to the Fortran 95 language that cannot be detected at compile time. A Fortran 95 language error is considered a severe error when the **LANGLVL** run-time option has been specified with the value **95STD** and the **ERR\_RECOVERY** run-time option has either not been set or is set to **NO**. If both **LANGLVL=95STD** and **ERR\_RECOVERY=YES** have been specified, the error is considered a recoverable error. If **LANGLVL=EXTENDED** is specified, the error condition is not considered an error.

A Fortran 2003 Standard language error results from the use of XL Fortran extensions to the Fortran 2003 language standard that cannot be detected at compile time. A Fortran 2003 language error is considered a severe error when the **LANGLVL** run-time option has been specified with the value **2003STD** and the **ERR\_RECOVERY** run-time option has either not been set or is set to **NO**. If both **LANGLVL=2003STD** and **ERR\_RECOVERY=YES** have been specified, the error is considered a recoverable error. If **LANGLVL=EXTENDED** is specified, the error condition is not considered an error.

*Table 24. IOSTAT Values for Fortran 90, 95, and 2003 Standard Language Error Conditions*

<b>IOSTAT Value</b>	<b>Error Description</b>
53	Mismatched edit descriptor and item type in formatted I/O.
58	Format specification error.
140	Unit is not connected when the I/O statement is attempted. Only for READ, WRITE, PRINT, REWIND, and ENDFILE.
141	Two ENDFILE statements without an intervening REWIND or BACKSPACE on the unit.
151	The FILE= specifier is missing and the STATUS= specifier does not have a value of 'SCRATCH' on an OPEN statement.
187	NAMELIST comments are not allowed by the Fortran 90 standard.
199	STREAM is not a valid value for the ACCESS= specifier on an OPEN statement in Fortran 90 or Fortran 95.

---

## Chapter 10. Input/Output formatting

Formatted **READ**, **WRITE** and **PRINT** data transfer statements use formatting information to direct the conversion between internal data representations and character representations in a formatted record. You can control the conversion process, called editing, by using a formatting type. The *Formatting and Access Types* table details the access types that support each formatting type.

Table 25. *Formatting and access types*

Formatting Type	Access Types
Format-directed	sequential, direct, and stream
List-directed	sequential and stream
Namelist	sequential and stream

Editing occurs on all fields in a record. A field is the part of a record that is read on input or written on output when format control processes a data or character string edit descriptor. The field width is the size of that field in characters.

---

### Format-directed formatting

Format-directed formatting allows you to control editing using edit descriptors in a format specification. Specify a format specification in a **FORMAT** statement or as the value of a character array or character expression in a data transfer statement. Edit descriptors allow you to control editing in the following ways:

- Data edit descriptors allow you to specify editing by data type
- Control edit descriptors focus on the editing process
- Character string edit descriptors control string outputs

### Complex editing

To edit complex values, you must specify complex editing by using a pair of data edit descriptors. A complex value is a pair of separate real components. When specifying complex editing, the first edit descriptor applies to the real part of the number. The second edit descriptor applies to the imaginary part of the number.

You can specify different edit descriptors for a complex editing pair and use one or more control edit descriptors between the edit descriptors in that pair. You must not specify data edit descriptors between the edit descriptors in that pair.

### Data edit descriptors

Data edit descriptors allow you to specify editing by data type. You can use them to edit character, numeric, logical, and derived type data. The *Data Edit Descriptors* table contains a complete list of all character, character string, numeric, logical, and derived type edit descriptors. Numeric data refers to integer, real, and complex values.

Table 26. *Data edit descriptors*

Forms	Use
A Aw	Edits character values

Table 26. Data edit descriptors (continued)

Forms	Use
<b>Bw</b> <b>Bw.m</b>	Edits binary values
<b>DT</b> • <b>DTchar-literal-constant</b> • <b>DT(v-list)</b> • <b>DTchar-literal-constant(v-list)</b> •	Edits an item of derived type. You can use a procedure instead of the default input/output formatting of an item of derived type.
<b>Ew.d</b> <b>Ew.dEe</b> <b>Ew.dDe</b> * <b>Ew.dQe</b> * <b>Dw.d</b> <b>ENw.d</b> <b>ENw.dEe</b> <b>ESw.d</b> <b>ESw.dEe</b> <b>Qw.d</b> *	Edits real and complex numbers with exponents
<b>Fw.d</b>	Edits real and complex numbers without exponents
<b>Gw.d</b> <b>Gw.dEe</b> <b>Gw.dDe</b> * <b>Gw.dQe</b> *	Edits data fields of any intrinsic type, with the output format adapting to the type of the data and, if the data is of type real, the magnitude of the data
<b>Iw</b> <b>Iw.m</b>	Edits integer numbers
<b>Lw</b>	Edits logical values
<b>ow</b> <b>ow.m</b>	Edits octal values
<b>Q</b> *	Returns the count of characters remaining in an input record *
<b>Zw</b> <b>Zw.m</b>	Edits hexadecimal values

where:

*char-literal-constant*

Specifies a character literal constant in a DT edit descriptor that must not have a kind parameter.

• Fortran 2003

\* Specifies an IBM extension.

*d* Specifies the number of digits to the right of the decimal point.

*e* Specifies the number of digits in the exponent field.

*m* Specifies the number of digits to print.

*n* Specifies the number of characters in a literal field. Blanks are included in character count.

---

**Fortran 2003**

---

**v-list** A comma-separated list of integer literal constants that have the same kind

parameter.

End of Fortran 2003

*w* Specifies the width of a field including all blanks as a positive value.

**F95** If you specify the **B**, **F**, **I**, **O**, or **Z**, edit descriptors on output, the value of *w* can be zero. **F95**

## Rules for Data Edit Descriptor and Modifiers

You must not specify kind type parameters.

Edit descriptor modifiers must be unsigned integer literal constants.

IBM Extension

For the *w*, *m*, *d*, and *e* modifiers, you must enclose a scalar integer expression in angle brackets (< and >). See “Variable format expressions” on page 361 for details.

### Note:

There are two types of **Q** data edit descriptor:

#### extended precision **Q**

is the **Q** edit descriptor with the **Q***w.d* syntax

#### character count **Q**

is the **Q** edit descriptor with the **Q** syntax

End of IBM Extension

## Rules for numeric edit descriptors on input

Leading blanks are not significant. You can control the interpretation of other blanks using the **BLANK=** specifier in the **OPEN** or **READ** statements and the **BN** and **BZ** edit descriptors. A field of all blanks is treated as zero.

Plus signs are optional, though you must not specify plus signs for the **B**, **O**, and **Z** edit descriptors.

In **F**, **E**, **EN**, **ES**, **D**, **G**, and extended precision **Q** editing, a decimal point appearing in the input field overrides the portion of an edit descriptor that specifies the decimal point location. The field can contain more digits than can be represented internally.

### Input of IEEE Exceptional Values

For real and complex editing, XL Fortran can now input IEEE exceptional values. The Fortran 2003 standard specifies a set of values for IEEE NaN (Not-a-Number) and IEEE infinity which XL Fortran now supports, along with another set of IEEE NaN values that are unique to XL Fortran. Input of IEEE exceptional values under real and complex editing are governed by the field width of the real or complex edit descriptor. IEEE exceptional values are case insensitive during input. The **F**, **E**, **EN**, **ES**, **D**, **G**, and **Q** edit descriptors support the input of IEEE exceptional values.

The Fortran 2003 standard allows the following values for IEEE infinity: 'INF', '+INF', '-INF', 'INFINITY', '+INFINITY', or '-INFINITY'. These values can be preceded and followed by blanks.

The Fortran 2003 standard allows the following values for IEEE NaN: 'NaN', '+NaN', or '-NaN'. The sign that precedes 'NaN' will not have any significant meaning in XL Fortran. These values can also be preceded and followed by blanks. IEEE NaN can also be directly followed by zero or more characters in parentheses. The parentheses are used to indicate a quiet or signaling NaN. If only 'NaN' or 'NaN()' is specified it is interpreted as a quiet NaN. 'NaN(Q)' will be interpreted as a quiet NaN, and 'NaN(S)' as a signaling NaN. Any other alphanumeric characters specified inside the parentheses will have no significant meaning and will be interpreted as a quiet NaN by default.

As an IBM extension, XL Fortran allows the following values for IEEE NaN: 'NaNQ' or 'NaNS'. These exceptional values are case insensitive. 'NaNQ' will be interpreted as a quiet NaN and 'NaNS' as a signaling NaN. This form of IEEE NaN will only be allowed when the runtime option 'langlvl' is set to 'extended'.

### Rules for numeric data edit descriptors on output

Characters are right-justified in the field.

When the number of characters in a field is less than the field width, leading blanks fill the remaining field space.

When the number of characters in a field is greater than the field width, or if an exponent exceeds its specified width, asterisks fill the entire field space.

A minus sign prefixes a negative value. A positive or zero value does not receive a plus sign prefix on output, unless you specify the **S**, **SP**, or **SS** edit descriptors.

#### Fortran 95

If you specify the **-qxlf90** compiler option the **E**, **D**, **Q(Extended Precision)**, **F**, **EN**, **ES** and **G(General Editing)** edit descriptors output a negative value differently depending on the **signedzero** suboption.

- If you specify the **signedzero** suboption, the output field contains a minus sign for a negative value, even if that value is negative zero. This behavior conforms to the Fortran 95 and Fortran 2003 Standard.

#### IBM Extension

XL Fortran does not evaluate a **REAL(16)** internal value of zero as a negative zero.

#### End of IBM Extension

- If you specify the **nosignedzero** suboption, a minus sign is not written to the output field for a value of zero, even if the internal value is negative.

The **EN** and **ES** edit descriptors output a minus sign when the value is negative for the **signedzero** and **nosignedzero** suboptions.

#### End of Fortran 95

### Output of IEEE Exceptional Values

XL Fortran supports output of IEEE exceptional values for real and complex editing. Output of IEEE exceptional values can be Fortran 2003 standard compliant or compatible with previous releases of XL Fortran. A new compiler option and runtime option control the output of IEEE exceptional values. The

`-qxf2003=oldnaninf` compiler option will output IEEE exceptional values like previous releases of XL Fortran; whereas, `-qxf2003=nooldnaninf` will output IEEE exceptional values in accordance with the Fortran standard. In addition to the compiler option, a new runtime option, **naninfoutput**, can force the output of IEEE exceptional values to be Fortran 2003 standard compliant or compliant to the previous releases of XL Fortran. For more information on the **naninfoutput** runtime option see: Running XL Fortran programs section of the *XL Fortran Compiler Reference*. The **F**, **E**, **EN**, **ES**, **D**, **G**, and **Q** edit descriptors support the output of IEEE exceptional values.

Output of IEEE exceptional values under real and complex editing are governed by the field width of the real or complex edit descriptor. IEEE exceptional values are case sensitive during output.

### Fortran 2003 Standard Output

IEEE infinity is output as 'Inf'. It can be preceded by as many blanks as necessary to be right justified. If the internal value is positive infinity, it can also be directly preceded by an optional plus sign if the field width allows for it. If the field width is less than three, asterisks are output instead. However, if the **SIGN=** specifier has a value of 'PLUS' or the 'sp' descriptor is used, then the plus sign is mandatory and the minimum field width is 4. If the internal value is negative infinity, it must be preceded by a negative sign. The minimum field width is 4. If the field width is less than four, asterisks are output instead.

IEEE Nan is output as 'NaN'. It can be preceded by as many blanks as necessary to be right justified. If the field width is greater than or equal to five, the standard allows for zero or more alphanumeric characters in parentheses to optionally follow the 'NaN'. XL Fortran will output 'NaN(Q)' for a quiet NaN and 'NaN(S)' for a signaling NaN if the field width is greater than five, otherwise only a 'NaN' is output. If the field width is less than three, asterisks are output instead.

### Previous XL Fortran Output

IEEE infinity is output as 'INF'. It can be preceded by as many blanks as necessary to be right justified. If the field width is less than three, asterisks are output instead.

IEEE NaN is output as 'NaNQ' for a quiet NaN and 'NaNS' for a signaling NaN. It can also be directly preceded by an optional sign. It can be preceded by as many blanks as necessary to be right justified. If the field width is less than four, asterisks are output instead.

## Rules for derived type edit descriptors

---

### Fortran 2003

---

The **DT** edit descriptor allows you to provide a procedure instead of the default input/output formatting for processing a list item of derived type. If you specify the optional *char-literal-constant*, the character value DT is concatenated to the *char-literal-constant* and passed to your user-defined derived-type input/output procedure as the *iotype* argument.

The values in the *v-list* of the **DT** edit descriptor are passed to the derived-type input/output procedure you define as the *v\_list* array argument.

If a derived type variable or value corresponds to the **DT** edit descriptor, there must be an accessible interface to a derived type input/output procedure for that derived type.

You must not specify a DT edit descriptor as a non-derived type list item.

End of Fortran 2003

## Control edit descriptors

Table 27. Control edit descriptors

Forms	Use
/ <i>r</i> /	Specifies the end of data transfer on the current record
:	Specifies the end of format control if there are no more items in the input/output list
\$ *	Suppresses end-of-record in output *
BN	Ignores nonleading blanks in numeric input fields
BZ	Interprets nonleading blanks in numeric input fields as zeros
DC •	Specifies decimal comma as the decimal edit mode.
DP •	Specifies decimal point as the decimal edit mode.
<i>k</i> P	Specifies a scale factor for real and complex items.
RU •	Specifies the <b>UP</b> rounding mode.
RC •	Specifies the <b>COMPATIBLE</b> rounding mode.
RD •	Specifies the <b>DOWN</b> rounding mode.
RN •	Specifies the <b>NEAREST</b> rounding mode.
RP •	Specifies the <b>PROCESSOR_DEFINED</b> rounding mode.
RZ •	Specifies the <b>ZERO</b> rounding mode.
S SS	Specifies that plus signs are not to be written
SP	Specifies that plus signs are to be written
T <i>c</i>	Specifies the absolute position in a record from which, or to which, the next character is transferred
TL <i>c</i>	Specifies the relative position (backward from the current position in a record) from which, or to which, the next character is transferred
TR <i>c</i> <i>oX</i>	Specifies the relative position (forward from the current position in a record) from which, or to which, the next character is transferred

where:

- Fortran 2003
- \* specifies an IBM extension.
- r* is a repeat specifier. It is an unsigned, positive, integer literal constant.
- k* specifies the scale factor to be used. It is an optionally signed, integer literal constant.
- c* specifies the character position in a record. It is an unsigned, nonzero, integer literal constant.



$o$  is the relative character position in a record. It is an unsigned, nonzero, integer literal constant.

## Rules for Control Edit Descriptors and Modifiers

You must not specify kind type parameters.

### IBM Extension

$r$ ,  $k$ ,  $c$ , and  $o$  can also be expressed as an arithmetic expression enclosed by angle brackets that evaluates into an integer value.

### End of IBM Extension

## Character string edit descriptors

Character string edit descriptors allow you to edit character data.

Forms	Use	Page
$nHstr$	Outputs a character string ( $str$ )	243
' $str$ ' " $str$ "	Outputs a character string ( $str$ )	229

$n$  is the number of characters in a literal field. It is an unsigned, positive, integer literal constant. Blanks are included in character count. A kind type parameter cannot be specified.

## Apostrophe/Double quotation mark editing

**Purpose:** The apostrophe/double quotation mark edit descriptor specifies a character literal constant in an output format specification.

### Syntax:

- '*character string*'
- "*character string*"

**Rules:** The width of the output field is the length of the character literal constant. See "Character" on page 41 for additional information on character literal constants.

### IBM Extension

#### Notes:

1. A backslash is recognized, by default, as an escape sequence, and as a backslash character when the **-qnoescape** compiler option is specified. See escape sequences for more information.
2. XL Fortran provides support for multibyte characters within character constants, Hollerith constants, character-string edit descriptors, and comments. This support is provided through the **-qmbcs** option. Assignment of a constant containing multibyte characters to a variable that is not large enough to hold the entire string may result in truncation within a multibyte character.
3. Support is also provided for Unicode characters and filenames. If the environment variable **LANG** is set to **UNIVERSAL** and the **-qmbcs** compiler option is specified, the compiler can read and write Unicode characters and filenames.

**Examples:**

```

      ITIME=8
      WRITE(*,5) ITIME
5     FORMAT('The value is -- ',I2) ! The value is -- 8
      WRITE(*,10) ITIME
10    FORMAT(I2,'o'clock') ! 8o'clock
      WRITE(*,'(I2,7Ho'clock)') ITIME ! 8o'clock
      WRITE(*,15) ITIME
15    FORMAT("The value is -- ",I2) ! The value is -- 8
      WRITE(*,20) ITIME
20    FORMAT(I2,"o'clock") ! 8o'clock
      WRITE(*,'(I2,"o'clock)') ITIME ! 8o'clock

```

**Effective list items**

This section discusses the rules for expanding a data transfer statement's array and derived-type input/output list items. The scalar objects that result from the application of these rules are called effective items. Zero-sized arrays and implied-**DO** lists with an iteration count of zero do not contribute to the effective list items. A scalar character item of zero length is an effective list item.

The following rules are re-applied to each expanded list item until none of the rules applies.

1. If an array appears as an input/output list item, it is treated as if the elements, if any, were specified in array element order.
2. If a list item of derived type in an unformatted input/output statement is not processed by a user-defined derived-type input/output procedure, and if any subobject of that list item would be processed by a user-defined derived-type input/output procedure, the list item is treated as if all of the components of the object were specified in the list in component order. Those components are accessible in the scoping unit containing the input/output statement, and they must not be pointers or allocatable.
3. An effective input/output list item of derived type in an unformatted input/output statement is treated as a single value in a processor-dependent form, unless the list item or a subobject of a list item is processed by a user-defined derived-type input/output procedure.
4. If a list item of derived type in a *formatted* input/output statement is not processed by a user-defined derived-type input/output procedure, that list item is treated as if all of the components of the list item were specified in the list in component order. Those components are accessible in the scoping unit containing the input/output statement, and they must not be pointers or allocatable.
5. If a derived-type list item is not treated as a list of its individual components, its ultimate components cannot have the **POINTER** or **ALLOCATABLE** attribute, unless the list item is processed by a user-defined derived-type input/output procedure.

## Interaction of Input/Output lists and format specifications

Beginning format-directed formatting initiates format control. Each action of format control depends on the next edit descriptor in the format specification, and on the next effective item in the input/output list, if one exists.

If an input/output list specifies at least one effective item, at least one data edit descriptor must exist in the format specification. Note that an empty format specification (parentheses only) can be used only if there are no effective items in the input/output list or if each item is a zero-sized array or an implied-**DO** list with an iteration count of zero. If this is the case and advancing input/output is in effect, one input record is skipped, or one output record containing no characters is written. For nonadvancing input/output, the file position is left unchanged.

A format specification is interpreted from left to right, except when a repeat specification (*r*) is present. A format item that is preceded by a repeat specification is processed as a list of *r* format specifications or edit descriptors identical to the format specification or edit descriptor without the repeat specification.

One effective item specified by the input/output list corresponds to each data edit descriptor. An effective list item of complex type requires the interpretation of two **F**, **E**, **EN**, **ES**, **D**, **G**, or extended precision **Q** edit descriptors. No item specified by the input/output list corresponds to a control edit descriptor or character string edit descriptor. Format control communicates information directly with the record.

Format control operates as follows:

1. If a data edit descriptor is encountered, format control processes an effective input/output list item, if there is one, or terminates the input/output command if the list is empty. If the effective list item processed is of type complex, any two edit descriptors are processed.
2. The colon edit descriptor terminates format control if no more effective items are in the input/output list. If more effective items are in the input/output list when the colon is encountered, it is ignored.
3. If the end of the format specification is reached, format control terminates if the entire effective input/output list has been processed, or control reverts to the beginning of the format item terminated by the last preceding right parenthesis. The following items apply when the latter occurs:
  - The reused portion of the format specification must contain at least one data edit descriptor.
  - If reversion is to a parenthesis that is preceded by a repeat specification, the repeat specification is reused.
  - Reversion, of itself, has no effect on the scale factor, on the **S**, **SP**, or **SS** edit descriptors, or on the **BN** or **BZ** edit descriptors.
  - If format control reverts, the file is positioned in a manner identical to the way it is positioned when a slash edit descriptor is processed.

---

### IBM Extension

---

During a read operation, any unprocessed characters of the record are skipped whenever the next record is read. A comma or semicolon can be used as a value separator for noncharacter data in an input record processed under format-directed formatting. The value separator will override the format width specifications when it appears before the end of the field width. For example, the format (I10,F20.10,I4) will read the following record correctly:

-345, .05E-3, 12

It is important to consider the maximum size record allowed on the input/output medium when defining a Fortran record by a **FORMAT** statement. For example, if a Fortran record is to be printed, the record should not be longer than the printer's line length.

## Comma-separated Input/Output

### IBM Extension

When reading floating-point data using format-directed input/output, a comma that appears in the input terminates the field. This can be useful for reading files containing comma-separated values.

For example, the following program reads two reals using the E edit descriptor. It requires that the field width be 16 characters. The program attempts to read the remaining characters in the record as a character string.

```
> cat read.f
real a,b
character*10 c
open(11, access='sequential', form='formatted')
read(11, '(2e16.10, A)') a,b,c
print *, a
print *, b
print *, c
end
```

If the floating-point fields are 16 characters wide, as the format specifies, the program executes correctly. (0.4000000000E+02 is 16 characters long.)

```
> cat fort.11
0.4000000000E+020.3000000000E+02hello
> a.out
40.00000000
30.00000000
hello
```

But if the floating-point input contains less than 16 characters, errors occur because parts of the next field are read. (0.400000E+02 is 12 characters long.)

```
> cat fort.11
0.400000E+020.300000E+02hello
> a.out
1525-097 A READ statement using decimal base input found the invalid digit
'.' in the input file.
The program will recover by assuming a zero in its place.
1525-097 A READ statement using decimal base input found the invalid digit
'h' in the input file.
The program will recover by assuming a zero in its place.
1525-097 A READ statement using decimal base input found the invalid digit
'e' in the input file.
The program will recover by assuming a zero in its place.
1525-097 A READ statement using decimal base input found the invalid digit
'l' in the input file.
The program will recover by assuming a zero in its place.
1525-097 A READ statement using decimal base input found the invalid digit
'l' in the input file.
The program will recover by assuming a zero in its place.
1525-097 A READ statement using decimal base input found the invalid digit
```

```
'o' in the input file.  
The program will recover by assuming a zero in its place.  
INF  
0.0000000000E+00
```

If you use commas to terminate the fields, the floating-point values are read correctly. (0.400000E+02 is 12 characters long, but the fields are separated by commas.)

```
> cat fort.11  
0.400000E+02,0.300000E+02,hello  
> a.out  
40.00000000  
30.00000000  
hello
```

If decimal comma mode is in effect, a semicolon acts as a value separator instead of a comma.

End of IBM Extension

---

## Data edit descriptors

In the examples of data edit descriptors, a lowercase b in the Output column indicates that a blank appears at that position.

### A (Character) Editing

#### Purpose

The A edit descriptor directs the editing of character values. It can correspond to an input/output list item of type character or any other type. The kind type parameter of all characters transferred and converted is implied by the corresponding list item.

#### Syntax

- A
- Aw

#### Rules

On input, if  $w$  is greater than or equal to the length (call it  $len$ ) of the input list item, the rightmost  $len$  characters are taken from the input field. If the specified field width is less than  $len$ , the  $w$  characters are left-justified, with  $(len - w)$  trailing blanks added.

On output, if  $w$  is greater than  $len$ , the output field consists of  $(w - len)$  blanks followed by the  $len$  characters from the internal representation. If  $w$  is less than or equal to  $len$ , the output field consists of the leftmost  $w$  characters from the internal representation.

If  $w$  is not specified, the width of the character field is the length of the corresponding input/output list item.

Fortran 2003

During formatted stream access, character output is split across more than one record if it contains newline characters.

End of Fortran 2003

## B (Binary) Editing

### Purpose

The **B** edit descriptor directs editing between values of any type in internal form and their binary representation. (A binary digit is either 0 or 1.)

### Syntax

- **B***w*
- **B***w.m*

### Rules

On input, *w* binary digits are edited and form the internal representation for the value of the input list item. The binary digits in the input field correspond to the rightmost binary digits of the internal representation of the value assigned to the input list item. *m* has no effect on input.

On input, *w* must be greater than zero.

---

#### Fortran 95

On output, *w* can be zero. If *w* is zero, the output field consists of the least number of characters required to represent the output value.

---

#### End of Fortran 95

The output field for **B***w* consists of zero or more leading blanks followed by the internal value in a form identical to the binary digits without leading zeros. Note that a binary constant always consists of at least one digit.

The output field for **B***w.m* is the same as for **B***w*, except that the digit string consists of at least *m* digits. If necessary, the digit string is padded with leading zeros. The value of *m* must not exceed the value of *w* unless *w* is zero. If *m* is zero and the value of the internal data is zero, the output field consists of only blank characters, regardless of the sign control in effect.

If *m* is zero, *w* is positive and the value of the internal datum is zero, the output field consists of *w* blank characters. F95 If both *w* and *m* are zero, and the value of the internal datum is zero, the output field consists of only one blank character. F95

If the **nooldboz** suboption of the **-qxlf77** compiler option is specified (the default), asterisks are printed when the output field width is not sufficient to contain the entire output. On input, the **BLANK=** specifier and the **BN** and **BZ** edit descriptors affect the **B** edit descriptor.

---

#### IBM Extension

If the **oldboz** suboption of the **-qxlf77** compiler option is specified, the following occurs on output:

- **B***w* is treated as **B***w.m*, with *m* assuming the value that is the minimum of *w* and the number of digits required to represent the maximum possible value of the data item.

- The output consists of blanks followed by at least  $m$  digits. These are the rightmost digits of the number, zero-filled if necessary, until there are  $m$  digits. If the number is too large to fit into the output field, only the rightmost  $m$  digits are output.

If  $w$  is zero, the **oldboz** suboption will be ignored.

With the **oldboz** suboption, the **BLANK=** specifier and the **BN** and **BZ** edit descriptors do not affect the **B** edit descriptor.

End of IBM Extension

## Examples

### Examples of B editing on input:



Input	Format	Value
111	B3	7
110	B3	6

### Examples of B editing on output:







Value	Format	Output (with -qxlf77=oldboz)	Output (with -qxlf77=nooldboz)
7	B3	111	111
6	B5	00110	bb110
17	B6.5	b10001	b10001
17	B4.2	0001	****
22	B6.5	b10110	b10110
22	B4.2	0110	****
0	B5.0	bbbbb	bbbbb
2	B0	10	10

## E, D, and Q (Extended Precision) Editing

### Purpose

The **E**, **D**, and extended precision **Q** edit descriptors direct editing between real and complex numbers in internal form and their character representations with exponents. An **E**, **D**, or extended precision **Q** edit descriptor can correspond to an input/output list item of type real, to either part (real or imaginary) of an input/output list item of type complex,  or to any other type in XL Fortran, as long as the length is at least 4 bytes. 

### Syntax

- $Ew.d$
- $Ew.d Ee$
- $Dw.d$
-   $Ew.d De$  
-   $Ew.d Qe$  
-   $Qw.d$  

### Rules

The form of the input field is the same as for **F** editing.  $e$  has no effect on input.

The form of the output field for a scale factor of 0 is:

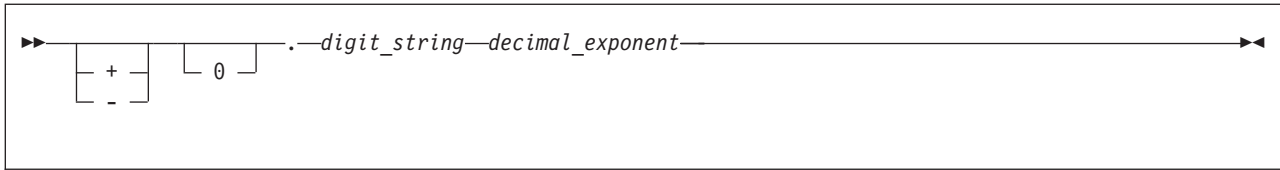

*digit\_string*

is a digit string whose length is the *d* most significant digits of the value after rounding.

*decimal\_exponent*

is a decimal exponent of one of the following forms (*z* is a digit):

Edit Descriptor	Absolute Value of Exponent (with scale factor of 0)	Form of Exponent
<i>Ew.d</i>	$ \text{decimal\_exponent}  \leq 99$	$E\pm z_1 z_2$
<i>Ew.d</i>	$99 <  \text{decimal\_exponent}  \leq 309$	$\pm z_1 z_2 z_3$
<i>Ew.dEe</i>	$ \text{decimal\_exponent}  \leq (10^e)-1$	$E\pm z_1 z_2 \dots z_e$
<i>Ew.dDe *</i>	$ \text{decimal\_exponent}  \leq (10^e)-1 *$	$D\pm z_1 z_2 \dots z_e *$
<i>Ew.dQe *</i>	$ \text{decimal\_exponent}  \leq (10^e)-1 *$	$Q\pm z_1 z_2 \dots z_e *$
<i>Dw.d</i>	$ \text{decimal\_exponent}  \leq 99$	$D\pm z_1 z_2$
<i>Dw.d</i>	$99 <  \text{decimal\_exponent}  \leq 309$	$\pm z_1 z_2 z_3$
<i>Qw.d *</i>	$ \text{decimal\_exponent}  \leq 99 *$	$Q\pm z_1 z_2 *$
<i>Qw.d *</i>	$99 <  \text{decimal\_exponent}  \leq 309 *$	$\pm z_1 z_2 z_3 *$

**Note:** \* IBM Extensions

The scale factor *k* (see “P (Scale Factor) Editing” on page 253) controls decimal normalization. If  $-d < k \leq 0$ , the output field contains  $|k|$  leading zeros and  $d - |k|$  significant digits after the decimal symbol. If  $0 < k < d+2$ , the output field contains *k* significant digits to the left of the decimal symbol and  $d-k+1$  significant digits to the right of the decimal symbol. You cannot use other values of *k*.

For general information about numeric editing on input, see “Rules for numeric edit descriptors on input” on page 225.

For more information regarding numeric editing on output, see “Rules for numeric data edit descriptors on output” on page 226.

## Examples

**Examples of E, D, and extended precision Q editing on input:** (Assume BN editing is in effect for blank interpretation.)

Input	Format	Value
12.34	E8.4	12.34
.1234E2	E8.4	12.34
2.E10	E12.6E1	2.E10

**Examples of E, D, and extended precision Q editing on output:**



Value	Format	Output (with <code>-qxlf77=noleadzero</code> )	Output (with <code>-qxlf77=leadzero</code> )
1234.56	E10.3	bb.123E+04	b0.123E+04
1234.56	D10.3	bb.123D+04	b0.123D+04

Fortran 95			
		(with <code>-qxlf90=signedzero</code> )	(with <code>-qxlf90=nosignedzero</code> )
-0.001	E5.2	-0.00	b0.00

End of Fortran 95

## DT Editing

Fortran 2003	
<b>Purpose</b>	The DT edit descriptor allows you to specify that a user-defined procedure is called instead of the default input/output formatting for processing an input/output list item of derived type
<b>Syntax</b>	<ul style="list-style-type: none"> <li>• DT</li> <li>• DT<i>char-literal-constant</i></li> <li>• DT( <i>v-list</i> )</li> <li>• DT<i>char-literal-constant</i>( <i>v-list</i> )</li> </ul>
<b>Rules</b>	<p>The <b>iotype</b> dummy argument passed to the user-defined input/output procedure contains the text from the <i>char-literal-constant</i>, prefixed with <b>DT</b>. If you do not include a <i>char-literal-constant</i>, the <b>iotype</b> argument contains only <b>DT</b>.</p> <p>The <i>v-list</i> is passed to the user-defined input/output procedure in the <i>v-list</i> integer array dummy argument. If you do not include a <i>v-list</i>, the <i>v-list</i> dummy argument is a zero-sized array.</p> <p>When you use the <b>DT</b> edit descriptor, the corresponding derived type input/output list item must be associated with an appropriate user-defined derived type input/output procedure.</p>

End of Fortran 2003

## EN Editing

### Purpose

The EN edit descriptor produces an output field in the form of a real number in engineering notation such that the decimal exponent is divisible by 3 and the absolute value of the significand is greater than or equal to 1 and less than 1000, except when the output value is zero. The scale factor has no effect on output.

The EN edit descriptor can correspond to an input/output list item of type real, to either part (real or imaginary) of an input/output list item of type complex,



or to any other type in XL Fortran, as long as the length is at least 4 bytes.

## Syntax

- EN $w.d$
- EN $w.dEe$

## Rules

The form and interpretation of the input field is the same as for F editing.

The form of the output field is:

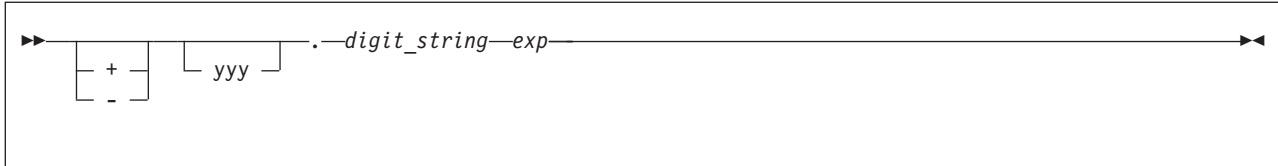

$yyy$  are the 1 to 3 decimal digits representative of the most significant digits of the value of the datum after rounding ( $yyy$  is an integer such that  $1 \leq yyy < 1000$  or, if the output value is zero,  $yyy = 0$ ).

$digit\_string$  are the  $d$  next most significant digits of the value of the datum after rounding.

$exp$  is a decimal exponent, divisible by 3, of one of the following forms ( $z$  is a digit):

Edit Descriptor	Absolute Value of Exponent	Form of Exponent
EN $w.d$	$ exp  \leq 99$	$E\pm z_1 z_2$
EN $w.d$	$99 <  exp  \leq 309$	$\pm z_1 z_2 z_3$
EN $w.dEe$	$ exp  \leq 10^e - 1$	$E\pm z_1 \dots z_e$

For general information about numeric editing on input, see “Rules for numeric edit descriptors on input” on page 225.

For more information regarding numeric editing on output, see “Rules for numeric data edit descriptors on output” on page 226.

## Examples

Value	Format	Output
3.14159	EN12.5	b3.14159E+00
1.41425D+5	EN15.5E4	141.42500E+0003
3.14159D-12	EN15.5E1	*****

Fortran 95			
-0.001	EN9.2	(with -qx1f90=signedzero) -1.00E-03	(with -qx1f90=nosignedzero) -1.00E-03
End of Fortran 95			

## ES Editing

### Purpose

The ES edit descriptor produces an output field in the form of a real number in scientific notation such that the absolute value of the significand is greater than or equal to 1 and less than 10, except when the output value is zero. The scale factor has no effect on output.

The ES edit descriptor can correspond to an input/output list item of type real, to either part (real or imaginary) of an input/output list item of type complex,  or to any other type in XL Fortran, as long as the length is at least 4 bytes.



### Syntax

- $ESw.d$
- $ESw.dEe$

### Rules

The form and interpretation of the input field is the same as for F editing.

The form of the output field is:

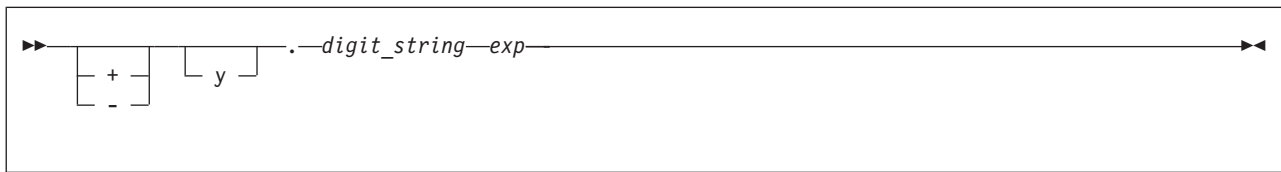

$y$  is a decimal digit representative of the most significant digit of the value of the datum after rounding.

$digit\_string$

are the  $d$  next most significant digits of the value of the datum after rounding.

$exp$  is a decimal exponent having one of the following forms ( $z$  is a digit):

Edit Descriptor	Absolute Value of Exponent	Form of Exponent
$ESw.d$	$ exp  \leq 99$	$E\pm z_1 z_2$
$ESw.d$	$99 <  exp  \leq 309$	$\pm z_1 z_2 z_3$
$ESw.dEe$	$ exp  \leq 10^e - 1$	$E\pm z_1 \dots z_e$

For general information about numeric editing on input, see “Rules for numeric edit descriptors on input” on page 225.

For more information regarding numeric editing on output, see “Rules for numeric data edit descriptors on output” on page 226.

### Examples

Value	Format	Output
31415.9	ES12.5	b3.14159E+04
14142.5D+3	ES15.5E4	bb1.41425E+0007
31415.9D-22	ES15.5E1	*****

Fortran 95			
-0.001	ES9.2	(with -qxlf90=signedzero) -1.00E-03	(with -qxlf90=nosignedzero) -1.00E-03
End of Fortran 95			

## F (Real without Exponent) Editing

### Purpose

The F edit descriptor directs editing between real and complex numbers in internal form and their character representations without exponents.

The F edit descriptor can correspond to an input/output list item of type real, to either part (real or imaginary) of an input/output list item of type complex,  or to any other type in XL Fortran, as long as the length is at least 4 bytes.



### Syntax

- *Fw.d*

### Rules

The input field for the F edit descriptor consists of, in order:

1. An optional sign.
2. A string of digits optionally containing a decimal symbol. If the decimal symbol is present, it overrides the *d* specified in the edit descriptor. If the decimal symbol is omitted, the rightmost *d* digits of the string are interpreted as following the decimal symbol, and leading blanks are converted to zeros if necessary.
3. Optionally, an exponent, having one of the following forms:
  - A signed digit string
  - E, D, or Q followed by zero or more blanks and by an optionally signed digit string. E, D, and Q are processed identically.

The output field for the F edit descriptor consists of, in order:

1. Blanks, if necessary.
2. A minus sign if the internal value is negative, or an optional plus sign if the internal value is zero or positive.
3. A string of digits that contains a decimal symbol and represents the magnitude of the internal value, as modified by the scale factor in effect and rounded to *d* fractional digits. See “P (Scale Factor) Editing” on page 253 for more information.

On input, *w* must be greater than zero.

Fortran 95	
In Fortran 95 on output, <i>w</i> can be zero. If <i>w</i> is zero, the output field consists of the least number of characters required to represent the output value.	
End of Fortran 95	

For general information about numeric editing on input, see “Rules for numeric edit descriptors on input” on page 225.

For more information regarding numeric editing on output, see “Rules for numeric data edit descriptors on output” on page 226.

## Examples

**Examples of F editing on input:** (Assume **BN** editing is in effect for blank interpretation.)

Input	Format	Value
-100	F6.2	-1.0
2.9	F6.2	2.9
4.E+2	F6.2	400.0

**Examples of F editing on output:**

Value	Format	Output (with <code>-qxlf77=noleadzero</code> )	Output (with <code>-qxlf77=leadzero</code> )
+1.2	F8.4	bb1.2000	bb1.2000
.12345	F8.3	bbbb.123	bbbb0.123
-12.34	F6.2	-12.34	-12.34

Fortran 95			
-12.34	F0.2	-12.34	-12.34
-0.001	F5.2	(with <code>-qxlf90=signedzero</code> ) -0.00	(with <code>-qxlf90=nosignedzero</code> ) b0.00
End of Fortran 95			

## G (General) Editing

### Purpose

The **G** edit descriptor can correspond to an input/output list item of any type. Editing of integer data follows the rules of the **I** edit descriptor; editing of real and complex data follows the rules of the **E** or **F** edit descriptors (depending on the magnitude of the value); editing of logical data follows the rules of the **L** edit descriptor; and editing of character data follows the rules of the **A** edit descriptor.

### Syntax

- *Gw.d*
- *Gw.dEe*
- IBM *Gw.dDe*  IBM
- IBM *Gw.dQe*  IBM

### Rules

**Generalized real and complex editing:** If the `nogedit77` suboption (the default) of the `-qxlf77` option is specified, the method of representation in the output field depends on the magnitude of the datum being edited. Let  $N$  be the magnitude of the internal datum. If  $0 < N < 0.1-0.5 \times 10^{-d-1}$  or  $N \geq 10^d-0.5$  or  $N$  is 0 and  $d$  is 0, *Gw.d* output editing is the same as *kPE w.d* output editing and *Gw.dEe* output editing is the same as *kPEw.dEe* output editing, where *kP* refers to the scale factor (“P (Scale Factor) Editing” on page 253) currently in effect. If  $0.1-0.5 \times 10^{-d-1} \leq N < 10^d-0.5$  or  $N$  is identically 0 and  $d$  is not zero, the scale factor has no effect, and the value of  $N$  determines the editing as follows:

Magnitude of Datum	Equivalent Conversion
$N = 0$	$F(w-n).(d-1),n('b')$ (d must not be 0)
$0.1-0.5 \times 10^{-d-1} \leq N < 1-0.5 \times 10^{-d}$	$F(w-n).d,n('b')$
$1-0.5 \times 10^{-d} \leq N < 10-0.5 \times 10^{-d+1}$	$F(w-n).(d-1),n('b')$
$10-0.5 \times 10^{-d+1} \leq N < 100-0.5 \times 10^{-d+2}$	$F(w-n).(d-2),n('b')$
...	...
$10^{d-2}-0.5 \times 10^{-2} \leq N < 10^{d-1}-0.5 \times 10^{-1}$	$F(w-n).1,n('b')$
$10^{d-1}-0.5 \times 10^{-1} \leq N < 10^d-0.5$	$F(w-n).0,n('b')$

where  $b$  is a blank.  $n$  is 4 for  $Gw.d$  and  $e+2$  for  $Gw.dEe$ . The value of  $w-n$  must also be positive.

Note that the scale factor has no effect unless the magnitude of the datum to be edited is outside the range that permits effective use of F editing.

#### IBM Extension

If  $0 < N < 0.1-0.5 \times 10^{-d-1}$ ,  $N \geq 10^d-0.5$ , or  $N$  is 0 and  $d$  is 0,  $Gw.dDe$  output editing is the same as  $kPEw.dDe$  output editing and  $Gw.dQe$  output editing is the same as  $kPEw.dQe$  output editing.

#### End of IBM Extension

On output, if the **gedit77** suboption of the **-qxlf77** compiler option is specified, the number is converted using either **E** or **F** editing, depending on the number. The field is padded with blanks on the right as necessary. Letting  $N$  be the magnitude of the number, editing is as follows:

- If  $N < 0.1$  or  $N \geq 10^d$ :
  - $Gw.d$  editing is the same as  $Ew.d$  editing
  - $Gw.dEe$  editing is the same as  $Ew.dEe$  editing.
- If  $N \geq 0.1$  and  $N < 10^d$ :

Magnitude of Datum	Equivalent Conversion
$0.1 \leq N < 1$	$F(w-n).d, n('b')$
$1 \leq N < 10$	$F(w-n).(d-1), n('b')$
.	.
.	.
$10^{d-2} \leq N < 10^{d-1}$	$F(w-n).1, n('b')$
$10^{d-1} \leq N < 10^d$	$F(w-n).0, n('b')$

**Note:** While FORTRAN 77 does not address how rounding of values affects the output field form, Fortran 90 does. Therefore, using **-qxlf77=gedit77** may produce a different output form than **-qxlf77=nogedit77** for certain combinations of values and **G** edit descriptors.

For general information about numeric editing on input, see “Rules for numeric edit descriptors on input” on page 225.

For more information regarding numeric editing on output, see “Rules for numeric data edit descriptors on output” on page 226.

### Examples

Value	Format	Output (with <code>-qxlf77=gedit77</code> )	Output (with <code>-qxlf77=nogedit77</code> )
0.0	G10.2	bb0.00E+00	bbb0.0
0.0995	G10.2	bb0.10E+00	bb0.10
99.5	G10.2	bb100.	bb0.10E+03

## H Editing

### Purpose

The **H** edit descriptor specifies a character string (*str*) and its length (*n*) in an output format specification. The string can consist of any of the characters allowed in a character literal constant.

### Syntax

- `nH str`

### Rules

If an **H** edit descriptor occurs within a character literal constant, the constant delimiter character (for example, apostrophe) can be represented within *str* if two such characters are consecutive. Otherwise, another delimiter must be used.

The **H** edit descriptor must not be used on input.

### Notes:

#### IBM Extension

1. A backslash is recognized, as an escape character by default, and as a backslash character when the **-qnoescape** compiler option is specified. See page 42 for more information on escape sequences.
2. XL Fortran provides support for multibyte characters within character constants, Hollerith constants, character-string edit descriptors, and comments. This support is provided through the **-qmbcs** option. Assignment of a constant containing multibyte characters to a variable that is not large enough to hold the entire string may result in truncation within a multibyte character.
3. Support is also provided for Unicode characters and filenames. If the environment variable **LANG** is set to **UNIVERSAL** and the **-qmbcs** compiler option is specified, the compiler can read and write Unicode characters and filenames.

#### End of IBM Extension

#### Fortran 95

4. Fortran 95 does not include the **H** edit descriptor, although it was part of both FORTRAN 77 and Fortran 90. See page “Deleted features” on page 818 for more information.



#### End of Fortran 95

## Examples

```
50  FORMAT(16HThe value is -- ,I2)
10  FORMAT(I2,7Ho'clock)
    WRITE(*,'(I2,7Ho'clock)') ITIME
```

## I (Integer) Editing

### Purpose



The I edit descriptor directs editing between integers in internal form and character representations of integers. The corresponding input/output list item can be of type integer  or any other type in XL Fortran. 

### Syntax

- $Iw$
- $Iw.m$

### Rules

$w$  includes the optional sign.

$m$  must have a value that is less than or equal to  $w$ ,  unless  $w$  is zero in Fortran 95. 

The input field for the I edit descriptor must be an optionally signed digit string, unless it is all blanks. If it is all blanks, the input field is considered to be zeros.

$m$  is useful on output only. It has no effect on input.

On input,  $w$  must be greater than zero.

### Fortran 95

On output,  $w$  can be zero. If  $w$  is zero, the output field consists of the least number of characters required to represent the output value.

### End of Fortran 95

The output field for the I edit descriptor consists of, in order:

1. Zero or more leading blanks
2. A minus sign, if the internal value is negative, or an optional plus sign, if the internal value is zero or positive
3. The magnitude in the form of:
  - A digit string without leading zeros if  $m$  is not specified
  - A digit string of at least  $m$  digits if  $m$  is specified and, if necessary, with leading zeros. If the internal value and  $m$  are both zero, blanks are written.

For additional information about numeric editing, see editing.

If  $m$  is zero,  $w$  is positive and the value of the internal datum is zero, the output field consists of  $w$  blank characters. If both  $w$  and  $m$  are zero and the value of the internal datum is zero, the output field consists of only one blank character.

## Examples

**Examples of I editing on input:** (Assume BN editing is in effect for blank interpretation.)



Input	Format	Value
-123	I6	-123
123456	I7.5	123456
1234	I4	1234

#### Examples of I editing on output:

Value	Format	Output
-12	I7.6	-000012
12345	I5	12345

Fortran 95		
0	I6.0	bbbbbb
0	I0.0	b
2	I0	2
End of Fortran 95		

## L (Logical) Editing

### Purpose

The L edit descriptor directs editing between logical values in internal form and their character representations. The L edit descriptor can correspond to an input/output list item of type logical,  or any other type in XL Fortran.



### Syntax

- $Lw$

### Rules

The input field consists of optional blanks, followed by an optional decimal symbol, followed by a T for true or an F for false.  $w$  includes blanks. Any characters following the T or F are accepted on input but are ignored; therefore, the strings .TRUE. and .FALSE. are acceptable input forms.

The output field consists of T or F preceded by  $(w - 1)$  blanks.

### Examples

#### Examples of L editing on input:

Input	Format	Value
T	L4	true
.FALSE.	L7	false

#### Examples of L editing on output:

Value	Format	Output
TRUE	L4	bbbT
FALSE	L1	F

## O (Octal) Editing

### Purpose

The O edit descriptor directs editing between values of any type in internal form and their octal representation. (An octal digit is one of 0-7.)

## Syntax

- $Ow$
- $Ow.m$

## Rules

$w$  includes blanks.

On input,  $w$  octal digits are edited and form the internal representation for the value of the input list item. The octal digits in the input field correspond to the rightmost octal digits of the internal representation of the value assigned to the input list item.  $m$  has no effect on input.

On input,  $w$  must be greater than zero.

### Fortran 95

On output,  $w$  can be zero. If  $w$  is zero, the output field consists of the least number of characters required to represent the output value.

### End of Fortran 95

The output field for  $Ow$  consists of zero or more leading blanks followed by the internal value in a form identical to the octal digits without leading zeros. Note that an octal constant always consists of at least one digit.

The output field for  $Ow.m$  is the same as for  $Ow$ , except that the digit string consists of at least  $m$  digits. If necessary, the digit string is padded with leading zeros. The value of  $m$  must not exceed the value of  $w$ , unless  $w$  is zero. If  $m$  is zero and the value of the internal datum is zero, the output field consists of only blank characters, regardless of the sign control in effect.

If the **nooldboz** suboption of the **-qxlf77** compiler option is specified (the default), asterisks are printed when the output field width is not sufficient to contain the entire output. On input, the **BLANK=** specifier and the **BN** and **BZ** edit descriptors affect the **O** edit descriptor.

### IBM Extension

If the **oldboz** suboption of the **-qxlf77** compiler option is specified, the following occurs on output:

- $Ow$  is treated as  $Ow.m$ , with  $m$  assuming the value that is the minimum of  $w$  and the number of digits required to represent the maximum possible value of the data item.
- The output consists of blanks followed by at least  $m$  digits. These are the rightmost digits of the number, zero-filled if necessary, until there are  $m$  digits. If the number is too large to fit into the output field, only the rightmost  $m$  digits are output.

If  $w$  is zero, the **oldboz** suboption will be ignored.

With the **oldboz** suboption, the **BLANK=** specifier and the **BN** and **BZ** edit descriptors do not affect the **O** edit descriptor.

### End of IBM Extension

If  $m$  is zero,  $w$  is positive and the value of the internal datum is zero, the output field consists of  $w$  blank characters. If both  $w$  and  $m$  are zero and the value of the internal datum is zero, the output field consists of only one blank character.

## Examples

### Examples of O editing on input:

Input	Format	Value
123	03	83
120	03	80

### Examples of O editing on output:

Value	Format	Output	Output
		(with <code>-qxlf77=oldboz</code> )	(with <code>-qxlf77=nooldboz</code> )
80	05	00120	bb120
83	02	23	**

Fortran 95			
0	05.0	bbbb	bbbb
0	00.0	b	b
80	00	120	120
End of Fortran 95			

## Q (Character Count) Editing

### IBM Extension

#### Purpose

The character count **Q** edit descriptor returns the number of characters remaining in an input record. The result can be used to control the rest of the input.

#### Syntax

- **Q**

#### Rules

There also exists the extended precision **Q** edit descriptor. By default, XL Fortran only recognizes the extended precision **Q** edit descriptor described earlier. See “E, D, and Q (Extended Precision) Editing” on page 235 for more information. To enable both **Q** edit descriptors, you must specify the `-qqcount` compiler option.

When you specify the `-qqcount` compiler option, the compiler will distinguish between the two **Q** edit descriptors by the way the **Q** edit descriptor is used. If only a solitary **Q** is found, the compiler will interpret it as the character count **Q** edit descriptor. If **Qw**. or **Qw.d** is encountered, XL Fortran will interpret it as the extended precision **Q** edit descriptor. You should use correct format specifications with the proper separators to ensure that XL Fortran correctly interprets which **Q** edit descriptor you specified.

The value returned as a result of the character count **Q** edit descriptor depends on the length of the input record and on the current character position in that record. The value is returned into a scalar integer variable on the **READ** statement whose position corresponds to the position of the character count **Q** edit descriptor in the **FORMAT** statement.

The character count **Q** edit descriptor can read records of the following file types and access modes:

- Formatted sequential external files. A record of this file type is terminated by a new-line character. Records in the same file have different lengths.
- Formatted sequential internal nonarray files. The record length is the length of the scalar character variable.
- Formatted sequential internal array files. The record length is the length of an element in the character array.
- Formatted direct external files. The record length is the length specified by the **RECL=** specifier in the **OPEN** statement.
- Formatted stream external files. A record of this file type is terminated by a new-line character. Records in the same file have different lengths.

In an output operation, the character count **Q** edit descriptor is ignored. The corresponding output item is skipped.

### Examples

```
@PROCESS QCOUNT
      CHARACTER(50) BUF
      INTEGER(4) NBYTES
      CHARACTER(60) STRING
      ...
      BUF = 'This string is 29 bytes long.'
      READ( BUF, FMT='(Q)' ) NBYTES
      WRITE( *,* ) NBYTES
! NBYTES equals 50 because the buffer BUF is 50 bytes long.
      READ(*,20) NBYTES, STRING
20    FORMAT(Q,A)
! NBYTES will equal the number of characters entered by the user.
      END
```

End of IBM Extension

## Z (Hexadecimal) Editing

### Purpose

The **Z** edit descriptor directs editing between values of any type in internal form and their hexadecimal representation. (A hexadecimal digit is one of 0-9, A-F, or a-f.)

### Syntax

- *Zw*
- *Zw.m*

### Rules

On input, *w* hexadecimal digits are edited and form the internal representation for the value of the input list item. The hexadecimal digits in the input field correspond to the rightmost hexadecimal digits of the internal representation of the value assigned to the input list item. *m* has no effect on input.

Fortran 95

On output, *w* can be zero. If *w* is zero, the output field consists of the least number

of characters required to represent the output value.

End of Fortran 95

The output field for  $Zw$  consists of zero or more leading blanks followed by the internal value in a form identical to the hexadecimal digits without leading zeros. Note that a hexadecimal constant always consists of at least one digit.

The output field for  $Zw.m$  is the same as for  $Zw$ , except that the digit string consists of at least  $m$  digits. If necessary, the digit string is padded with leading zeros. The value of  $m$  must not exceed the value of  $w$ , **F95** unless  $w$  is zero. **F95** If  $m$  is zero and the value of the internal datum is zero, the output field consists of only blank characters, regardless of the sign control in effect.

If  $m$  is zero,  $w$  is positive and the value of the internal datum is zero, the output field consists of  $w$  blank characters.

Fortran 95

If both  $w$  and  $m$  are zero and the value of the internal datum is zero, the output field consists of only one blank character.

End of Fortran 95

If the **nooldboz** suboption of the **-qxlf77** compiler option is specified (the default), asterisks are printed when the output field width is not sufficient to contain the entire output. On input, the **BLANK=** specifier and the **BN** and **BZ** edit descriptors affect the **Z** edit descriptor.

IBM Extension

If the **oldboz** suboption of the **-qxlf77** compiler option is specified, the following occurs on output:

- $Zw$  is treated as  $Zw.m$ , with  $m$  assuming the value that is the minimum of  $w$  and the number of digits required to represent the maximum possible value of the data item.
- The output consists of blanks followed by at least  $m$  digits. These are the rightmost digits of the number, zero-filled if necessary, until there are  $m$  digits. If the number is too large to fit into the output field, only the rightmost  $m$  digits are output.

If  $w$  is zero, the **oldboz** suboption will be ignored.

With the **oldboz** suboption, the **BLANK=** specifier and the **BN** and **BZ** edit descriptors do not affect the **Z** edit descriptor.

End of IBM Extension

## Examples

### Examples of Z editing on input:

Input	Format	Value
0C	Z2	12
7FFF	Z4	32767

### Examples of Z editing on output:

Value	Format	Output (with -qxlf77=oldboz)	Output (with -qxlf77=nooldboz)
-1	Z2	FF	**
12	Z4	000C	bbbC

Fortran 95			
12	Z0	C	C
0	Z5.0	bbbbbb	bbbbbb
0	Z0.0	b	b

End of Fortran 95

## Control edit descriptors

### / (Slash) Editing

#### Purpose

The slash edit descriptor indicates the end of data transfer on the current record. The repeat specifier (*r*) has a default value of 1.

#### Syntax

- /
- r/

#### Rules

When you connect a file for input using sequential access, each slash edit descriptor positions the file at the beginning of the next record.

When you connect a file for output using sequential access, each slash edit descriptor creates a new record and positions the file to write at the start of the new record.

When you connect a file for input or output using direct access, each slash edit descriptor increases the record number by one, and positions the file at the beginning of the record that has that record number.

Fortran 2003	
When you connect a file for input using stream access, each slash edit descriptor positions the file at the beginning of the next record, skipping the remaining portion of the current record. On output to a file connected for stream access, a newly created empty record follows the current record. The new record becomes both the current and last record of the file, with the file position coming at the beginning of the new record.	

End of Fortran 2003

#### Examples

```
500  FORMAT(F6.2 / 2F6.2)
100  FORMAT(3/)
```

## : (Colon) Editing

### Purpose

The colon edit descriptor terminates format control if no more items are in the input/output list. If more items are in the input/output list when the colon is encountered, it is ignored.

### Syntax

- :

### Rules

See “Interaction of Input/Output lists and format specifications” on page 231 for more information.

### Examples

```
10   FORMAT(3(:'Array Value',F10.5)/)
```

## \$ (Dollar) Editing

### IBM Extension

### Purpose

The dollar edit descriptor inhibits an end-of-record for a sequential or formatted stream **WRITE** statement.

### Syntax

- \$

### Rules

Usually, when the end of a format specification is reached, data transmission of the current record ceases and the file is positioned so that the next input/output operation processes a new record. But, if a dollar sign occurs in the format specification, the automatic end-of-record action is suppressed. Subsequent input/output statements can continue writing to the same record.

### Examples

A common use for dollar sign editing is to prompt for a response and read the answer from the same line.

```
      WRITE(*,FMT='($, A)') 'Enter your age  '
      READ(*,FMT='(BN, I3)') IAGE
      WRITE(*,FMT=1000)
1000  FORMAT('Enter your height: ', $)
      READ(*,FMT='(F6.2)') HEIGHT
```

### End of IBM Extension

## BN (Blank Null) and BZ (Blank Zero) Editing

### Purpose

The **BN** and **BZ** edit descriptors control the interpretation of nonleading blanks by subsequently processed **I**, **F**, **E**, **EN**, **ES**, **D**, **G**, **B**, **O**, **Z**, and extended precision **Q** edit descriptors. **BN** and **BZ** have effect only on input.

## Syntax

- **BN**
- **BZ**

## Rules

**BN** specifies that blanks in numeric input fields are to be ignored, and remaining characters are to be interpreted as though they were right-justified. A field of all blanks has a value of zero.

**BZ** specifies that nonleading blanks in numeric input fields are to be interpreted as zeros.

The initial setting for blank interpretation is determined by the **BLANK=** specifier of the **OPEN** statement. (See “OPEN” on page 400.) The initial setting is determined as follows:

- If **BLANK=** is not specified, blank interpretation is the same as if **BN** editing were specified.
- If **BLANK=** is specified, blank interpretation is the same as if **BN** editing were specified when the specifier value is **NULL**, or the same as if **BZ** editing were specified when the specifier value is **ZERO**.

The initial setting for blank interpretation takes effect at the start of a formatted **READ** statement and stays in effect until a **BN** or **BZ** edit descriptor is encountered or until format control finishes. Whenever a **BN** or **BZ** edit descriptor is encountered, the new setting stays in effect until another **BN** or **BZ** edit descriptor is encountered, or until format control terminates.

### IBM Extension

If you specify the **oldboz** suboption of the **-qxlf77** compiler option, the **BN** and **BZ** edit descriptors do not affect data input edited with the **B**, **O**, or **Z** edit descriptors. Blanks are interpreted as zeros.

End of IBM Extension

## DC and DP (Decimal) Editing

### Fortran 2003

#### Purpose

Decimal edit descriptors, **DC** and **DP** change the decimal edit mode to decimal comma and decimal point respectively.

#### Syntax

- **DC**
- **DP**

#### Rules

The decimal edit descriptors are used to control the representation of the decimal symbol in formatted input and output. The decimal comma or decimal point mode is in effect when the corresponding edit descriptor is encountered. They continue to be in effect until another **DC** or **DP** edit descriptor is encountered or until the end of the current I/O statement is reached.



## Examples

```
program main
  real :: pi=3.14
  print '(t2, dp, f4.2)', pi
  print '(t2, dc, f4.2)', pi
end program
```

Output  
3.14  
3,14

End of Fortran 2003

## P (Scale Factor) Editing

### Purpose

The scale factor,  $k$ , applies to all subsequently processed **F**, **E**, **EN**, **ES**, **D**, **G**, and extended precision **Q** edit descriptors until another scale factor is encountered or until format control terminates. The value of  $k$  is zero at the beginning of each input/output statement. It is an optionally signed integer value representing a power of ten.

### Syntax

- $kP$

### Rules

On input, when an input field using an **F**, **E**, **EN**, **ES**, **D**, **G**, or extended precision **Q** edit descriptor contains an exponent, the scale factor is ignored. Otherwise, the internal value equals the external value multiplied by  $10^{(k)}$ .

On output:

- In **F** editing, the external value equals the internal value multiplied by  $10^k$ .
- In **E**, **D**, and extended precision **Q** editing, the external decimal field is multiplied by  $10^k$ . The exponent is then reduced by  $k$ .
- In **G** editing, fields are not affected by the scale factor unless they are outside the range that can use **F** editing. If the use of **E** editing is required, the scale factor has the same effect as with **E** output editing.
- In **EN** and **ES** editing, the scale factor has no effect.

### Examples

#### Examples of P editing on input:

Input	Format	Value
98.765	3P,F8.6	.98765E-1
98.765	-3P,F8.6	98765.
.98765E+2	3P,F10.5	.98765E+2

#### Examples of P editing on output:

Value	Format	Output (with -qxlf77=noleadzero)	Output (with -qxlf77=leadzero)
5.67	-3P,F7.2	bbb0.01	bbb0.01
12.34	-2P,F6.4	b.1234	0.1234
12.34	2P,E10.3	b12.34E+00	b12.34E+00

## RC, RD, RN, RP, RU, and RZ (Round) Editing

Fortran 2003

### Purpose

Round edit descriptors are used in a Format statement and are one of **RC**, **RD**, **RN**, **RP**, **RU**, and **RZ**, which correspond to the **COMPATIBLE**, **DOWN**, **NEAREST**, **PROCESSOR\_DEFINED**, **UP**, and **ZERO** rounding modes respectively. The round edit descriptors temporarily change the connections rounding mode in formatted I/O. The round edit descriptors only affect **D**, **E**, **ES**, **EN**, **F** and **G** editing.

### Syntax

- **RC**
- **RD**
- **RN**
- **RU**
- **RZ**

### Rules

The round edit descriptors help specify how decimal numbers are converted to an internal representation (i.e. in binary) from a character representation and vice versa during formatted input and output.

### Examples

```
program main
  real :: i
  100 format (f10.7, ru )
  open(UNIT=2,file ='temp.txt', form='formatted', round='compatible' )
  read(UNIT=2, 100) i
  print '(f10.7 , ru)' i
end program
```

```
Input - temp.txt
3.1415926
Output - temp.txt
3.1415928
```

End of Fortran 2003

## S, SP, and SS (Sign Control) Editing

### Purpose

The **S**, **SP**, and **SS** edit descriptors control the output of plus signs by all subsequently processed **I**, **F**, **E**, **EN**, **ES**, **D**, **G**, and extended precision **Q** edit descriptors until another **S**, **SP**, or **SS** edit descriptor is encountered or until format control terminates.

The sign control edit descriptors can temporarily overwrite the **SIGN** mode set by the **SIGN=specifier** for the connection. The **S**, **SP**, and **SS** edit descriptors set the sign mode corresponding to the **SIGN=specifier** values **default**, **PLUS** and **SUPPRESS**, respectively.

## Syntax

- S
- SP
- SS

## Rules

S and SS specify that plus signs are not to be written. (They produce identical results.) SP specifies that plus signs are to be written.

## Examples

Value	Format	Output
12.3456	S,F8.4	b12.3456
12.3456	SS,F8.4	b12.3456
12.3456	SP,F8.4	+12.3456

## T, TL, TR, and X (Positional) Editing

### Purpose

The T, TL, TR, and X edit descriptors specify the position where the transfer of the next character to or from a record starts.

### Syntax

- T $c$
- TL $c$
- TR $c$
- oX

### Rules

The T and TL edit descriptors use the left tab limit for file positioning. Immediately before the non-child data transfer the definition of the left tab limit is the character position of the current record or the current position of the stream file. The T, TL, TR, and X specify the character position as follows:

- For T $c$ , the  $c$ th character position of the record, relative to the left tab limit.
- For TL $c$ ,  $c$  characters backward from the current position unless  $c$  is greater than the difference between the current character position and the left tab limit. Then, transmission of the next character to or from the record occurs at the left tab limit.
- For TR $c$ ,  $c$  characters forward from the current position.
- For oX,  $o$  characters forward from the current position.

The TR and X edit descriptors give identical results.

On input, a TR or X edit descriptor can specify a position beyond the last character of the record if no characters are transferred from that position.

On output, a T, TL, TR, or X edit descriptor does not by itself cause characters to be transferred. If characters are transferred to positions at or after the position specified by the edit descriptor, positions skipped and previously unfilled are filled with blanks. The result is the same as if the entire record were initially filled with blanks.

On output, a T, TL, TR, or X edit descriptor can result in repositioning so that subsequent editing with other edit descriptors causes character replacement.

The X edit descriptor can be specified without a character position. It is treated as 1X. When the source file is compiled with `-qlanglvl=90std` or `-qlanglvl=95std`, this extension is disabled in all compile-time format specifications, and the form of `oX` is enforced. To disable this extension in run-time formats, the following run-time option must be set:

```
XLFRTEOPTS="langlvl=90std" or "langlvl=95std" ; export XLFRTEOPTS
```

---

End of IBM Extension

---

## Examples

### Examples of T, TL, and X editing on input:

```
150  FORMAT(I4,T30,I4)
200  FORMAT(F6.2,5X,5(I4,TL4))
```

### Examples of T, TL, TR, and X editing on output:

```
50   FORMAT('Column 1',5X,'Column 14',TR2,'Column 25')
100  FORMAT('aaaaa',TL2,'bbbb',5X,'cccc',T10,'dddd')
```

---

## List-directed formatting

List-directed formatting allows you to control the editing process using the lengths and types of data that is read or written. You can only use list-directed formatting with sequential or stream access.

Use the asterisk format identifier to specify list-directed formatting. For example:

```
REAL TOTAL1, TOTAL2
PRINT *, TOTAL1, TOTAL2
```

## Value separators

If you specify list-directed formatting for a formatted record, that record consists of a sequence of values and value separators.

where:

**value** is a constant or null.

**value separator**

is a comma, slash, semicolon or set of adjacent blanks that occur between values in a record. You can specify one or more blanks before and after a comma or slash. If decimal comma mode is in effect, a semicolon replaces a comma as a value separator.

**null** is one of the following:

- Two successive commas, with zero or more intervening blanks.
- A comma followed by a slash, with zero or more intervening blanks.
- An initial comma in the record, preceded by zero or more blanks.

A null value has no effect on the definition status of the corresponding input list item.

## List-directed input

Effective input list items in a list-directed **READ** statement are defined by corresponding values in a formatted record. The syntax of each value must agree with the type of the corresponding effective input list item.

Table 28. List-directed input

Syntax	Type
$c$	A literal constant of intrinsic type, or a non-delimited character constant.
$r *$	$r$ is an unsigned, nonzero, integer literal constant. $r *$ indicates $r$ successive appearances of the null value.
$r * c$	Indicates $r$ successive appearances of the constant.

### Rules for list-directed input

You must not specify a kind type parameter for  $c$  or  $r$ .

List-directed formatting interprets two or more consecutive blanks as a single blank, unless the blanks are within a character value.

The constant  $c$  will have the same kind type parameter as the corresponding list item.

#### IBM Extension

Use the **-qintlog** compiler option to specify integer or logical values for input items of either integer or logical type.

#### End of IBM Extension

List-directed formatting interprets an object of derived type that occurs in an input list as if all structure components occur in the same order as in the derived type definition. The ultimate components of the derived type must not have the pointer **F2003** or allocatable **F2003** attribute.

A slash indicates the end of the input list and terminates list-directed formatting. Additional input list items after the slash evaluate as null values. If a slash is encountered by a child **READ** statement, it indicates the end of the input list for that particular child **READ** statement only. Any other input in the record following the slash is ignored. The slash has no effect on other child **READ** statements in the user-defined derived type I/O procedure or the parent **READ** statement.

### Continuing a character value

A character value that meets the following conditions can continue in as many records as necessary:

- The next item or ultimate component of a derived type is of type character.
- The character constant does not contain the value separators blank, comma, or slash
- The character constant does not cross a record boundary.
- The first non-blank character is not a quotation mark or apostrophe.
- The leading characters are non numeric and followed by an asterisk.
- The character constant contains at least one character.

Delimiting apostrophes or quotation marks are not necessary to continue a character value across multiple records. If you omit delimiting characters, the first blank, comma, slash, or end-of-record terminates the character constant.

If you do not specify delimiting apostrophes or quotation marks, apostrophes and double quotation marks in the character value are not doubled.

### End-of-record and list-directed input

In list-directed input an end-of-record has the same effect as a blank separator, unless the blank is within a character literal constant or complex literal constant. An end-of record does not insert a blank or any other character in a character value. An end-of-record must not occur between a doubled apostrophe in an apostrophe-delimited character sequence, or between a doubled quote in a quote-delimited character sequence

## List-directed output

List-directed **PRINT** and **WRITE** statements output values in an order identical to the output list. Values are written in a form valid for the data type of each output list item.

### Types of list-directed output

Table 29. List-directed output

Data Type	Form of Output
Arrays	Column-major order
Character	Depends on <b>DELIM=</b> specifier and file type, see Character Output.
Complex	Enclosed in parentheses with a comma separating the real and imaginary parts. Uses <b>E</b> or <b>F</b> editing.
Derived Types	User-defined derived-type I/O procedure.
Integer	Uses <b>I</b> editing.
Logical	T for a true value F for a false value
Real	Uses <b>E</b> or <b>F</b> editing.

### List-directed character output

The output of character constants can change depending on the **DELIM=** specifier on the **OPEN** or **READ** statements.

Character constants output to a file opened without a **DELIM=** specifier, or a file opened with a **DELIM=** specifier with a value of **NONE**, output as follows:

- Values are not delimited by apostrophes or quotation marks.
- Value separators do not occur between values. Value separators will be emitted around the output of format-directed child I/O statements that have a list-directed parent statement.
- Each internal apostrophe or double quotation mark outputs as one apostrophe or double quotation mark.
- The processor inserts a blank character for carriage control at the beginning of any record that continues a character constant from the preceding record.

**Note:** Non-delimited character data can not always be read back correctly using list-directed input. Use with discretion.

Double quotation marks delimit character constants in a file opened with a **DELIM=** specifier with a value of QUOTE. A value separator follows the delimiter. Each internal quote outputs as two contiguous double quotation marks.

Apostrophes delimit character constants in a file opened with a **DELIM=** specifier with a value of APOSTROPHE. A value separator follows the delimiter. Each internal apostrophe outputs as two contiguous apostrophes.

### Rules for list-directed output

Each output record begins with a blank character that provides carriage control when that record outputs.

The end-of-record must not occur within a constant that is not character or complex.

In a complex constant, the end of a record can occur between the comma and the imaginary part of the constant only if the constant is as long or longer than a record. The only embedded blanks that can occur within a complex constant are one blank between the comma and the end of a record, and one blank at the beginning of the next record.

Blanks must not occur within a constant that is not character or complex.

Null values are not output.

Slashes you specify as value separators are not output.

### IBM Extension

For output that does not involve a user-defined derived-type I/O procedure, the *Width of a Written Field* table contains the width of the written field for any data type and length. The size of the record is the sum of the field widths plus one byte to separate each non-character field.

Table 30. Width of a written field

Data Type	Length (bytes)	Maximum Field Width (characters)	Fraction (decimal digits)	Precision/IEEE (decimal digits)
integer	1	4	n/a	n/a
	2	6	n/a	n/a
	4	11	n/a	n/a
	8	20	n/a	n/a
real	4	17	10	7
	8	26	18	15
	16	43	35	31
complex	8	37	10	7
	16	55	18	15
	32	89	35	31
logical	1	1	n/a	n/a
	2	1	n/a	n/a
	4	1	n/a	n/a
	8	1	n/a	n/a

Table 30. Width of a written field (continued)

Data Type	Length (bytes)	Maximum Field Width (characters)	Fraction (decimal digits)	Precision/IEEE (decimal digits)
character	n	n	n/a	n/a

End of IBM Extension

## Namelist formatting

Namelist formatting allows you to use the **NAME=** specifier as part of the **NAMELIST** statement to assign a name to a collection of variables. This name represents the entire collection of variables for input and output. You can also use namelist formatting to include namelist comments with input, making the data more user accessible.

- In Fortran 90 and Fortran 95, you can only use namelist formatting with sequential access.
- The Fortran 2003 Standard allows you to use namelist formatting with sequential and stream access.
- The Fortran 2003 Standard allows you to use namelist formatting with internal files.

## Namelist input

The form of namelist input is:

1. Optional blanks and namelist comments.
2. The ampersand character, followed immediately by the namelist group name specified in the **NAMELIST** statement.
3. One or more blanks.
4. A sequence of zero or more name-value subsequences, separated by value separators.
5. A slash to terminate the namelist input.

Blanks at the beginning of an input record that continues a delimited character constant are considered part of the constant.

IBM Extension

If you specify the **NAMELIST=OLD** run-time option, the form of input for a **NAMELIST** statement is:

1. Optional blanks
2. An ampersand or dollar sign, followed immediately by the namelist group name specified in the **NAMELIST** statement.
3. One or more blanks.
4. A sequence of zero or more name-value subsequences separated by a single comma. You can insert a comma after the last name-value subsequence.
5. **&END** or **\$END** to terminate the namelist input.

End of IBM Extension



The first character of each input record must be a blank, including those records that continue a delimited character constant.

## Namelist comments

### Fortran 95

In Fortran 95 and higher, you can use comments in namelists.

### Fortran 2003

You must not specify comments in stream input.

### End of Fortran 2003

If you specify the `NAMELIST=NEW` run-time option:

- If you specify an exclamation point after a value separator that is not a slash, or in the first non-blank position of a namelist input record, you initiate a comment. You can not initiate comments inside character literal constants.
- The comment extends to the end of the input record, and can contain any character in the XL Fortran character set.
- The comment is ignored.
- A slash within a namelist comment does not terminate execution of that namelist input statement.

### IBM Extension

If you specify the `NAMELIST=OLD` run-time option:

- If you specify an exclamation point after a single comma or in the first non-blank position of a namelist input record that is not the first character of that record, you initiate a comment. You must not initiate a namelist comment within a character literal constant.
- The comment extends to the end of the input record, and can contain any character in the XL Fortran character set.
- The comment is ignored.
- An `&END` or `$END` within a namelist comment does not terminate execution of the namelist input statement.

### End of IBM Extension

### End of Fortran 95

## Name-value subsequence

The form of a name-value subsequence in an input record is:

▶▶ *name* = *constant\_list* ▶▶

*name* is a variable

*constant*  
has the following forms:

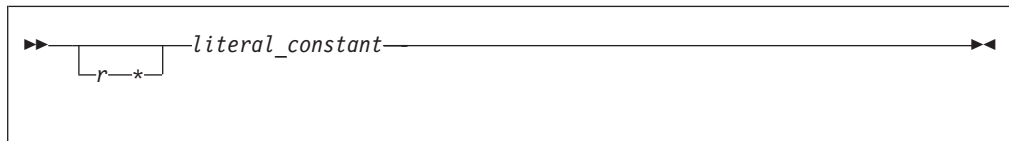

*r* is an unsigned, nonzero, scalar, integer literal constant specifying the number of times the *literal\_constant* occurs. You must not specify a kind type parameter for *r*.

*literal\_constant* is a scalar literal constant of intrinsic type, or null value. You must not specify a kind type parameter for the constant. The constant evaluates with the same kind type parameter as the corresponding list item.

You must specify delimiting apostrophes or quotation marks if *literal\_constant* is of type character.

You can specify T or F if *literal\_constant* is of type logical.

## Rules for namelist input

Any subscripts, strides, and substring range expressions that qualify *name* must be integer literal constants with no kind type parameter.

If *name* is not an array or an object of derived type, *constant\_list* must contain a single constant.

Variable names you specify in the input file must appear in the *variable\_name\_list* of a **NAMelist** statement. Variables can appear in any order.

If a name that you specify in an **EQUIVALENCE** statement shares storage with *name*, you must not substitute for that name in the *variable\_name\_list*.

You can use one or more optional blanks before or after *name*, but *name* must not contain embedded blanks.

In each name-value subsequence, the name must be the name of a namelist group item with an optional qualification. The name with the optional qualification must not be a:

- zero-sized array.
- zero-sized array section.
- zero-length character string.

If you specify the optional qualification, it must not contain a vector subscript.

If *name* is an array, array section without vector subscripts, or a structure, *name* expands where applicable into a sequence of scalar list items of intrinsic data type according to the rules outlined in “Effective list items” on page 230.

If *name* is an array or structure, the number of constants in *constant\_list* must be less than or equal to the number of items specified by the expansion of *name*. If the number of constants is less than the number of items, the remaining items retain their former values.

You can specify a null value using:

- The  $r^*$  form that indicates  $r$  successive appearances of the null value.
- Blanks between two consecutive value separators following an equal sign.
- Zero or more blanks preceding the first value separator and following an equal sign.
- Two consecutive non-blank value separators.

A null value has no effect on the definition status of the corresponding input list item. If the namelist group object list item is defined, it retains its previous value; if it is undefined, it remains undefined.

If decimal comma mode is in effect, a semicolon acts as a value separator instead of a comma.

You must not use a null value as the real or imaginary part of a complex constant. A single null value can represent an entire complex constant.

The end of a record following a value separator, with or without intervening blanks, does not specify a null value.

#### IBM Extension

When you set the **LANGLVL=EXTENDED** run-time option, XL Fortran allows you to specify multiple input values in conjunction with a single array element. XL Fortran assigns the values to successive elements of that array, in array element order. The array element must not specify subobject designators.

Consider the following example, which declares array A as follows:

```
INTEGER A(100)
NAMELIST /F00/ A
READ (5, F00)
```

Unit 5 contains the following input:

```
&F00
A(3) = 2, 10, 15, 16
/
```

During execution of the **READ** statement, XL Fortran assigns the following values:

- 2 to A(3)
- 10 to A(4)
- 15 to A(5)
- 16 to A(6)

If you specify multiple values in conjunction with a single array element, any logical constant must be specified with a leading period, for example, `.T.`

If you use the **NAMELIST=OLD** option at run-time, the **BLANK=** specifier in the **OPEN** or **READ** statements determines how XL Fortran interprets embedded and trailing blanks between non-character constants.

If you specify the **-qmixed** compiler option, the namelist group name and list item names are case-sensitive.

#### End of IBM Extension

A slash appearing as a value separator terminates the input statement after assignment of the previous value. Any additional items in the namelist group object receive null values

### Example of namelist input data

File NMLEXP contains the following data before execution of the **READ** statement.

Character position:

```
          1          2          3
1...+....0....+....0....+....0
```

File contents:

```
&NAME1
I=5,
SMITH%P_AGE=27
/
```

NMLEXP contains four data records. The program contains the following:

```
TYPE PERSON
  INTEGER P_AGE
  CHARACTER(20) P_NAME
END TYPE PERSON
TYPE(PERSON) SMITH
NAMELIST /NAME1/ I,J,K,SMITH
I=1
J=2
K=3
SMITH=PERSON(20,'John Smith')
OPEN(7,FILE='NMLEXP')
READ(7,NML=NAME1)
! Only the value of I and P_AGE in SMITH are
! altered (I = 5, SMITH%P_AGE = 27).
! J, K and P_NAME in SMITH remain the same.
END
```

**Note:** In the previous example, data items appear in separate data records. The next example is a file with the same data items in one data record:

Character position:

```
          1          2          3          4
1...+....0....+....0....+....0....+....0
```

File contents:

```
&NAME1 I= 5, SMITH%P_AGE=40 /
```

### Fortran 95

An example of a **NAMelist** comment when you specify **NAMelist=NEW**. The comment appears after the value separator space.

```
&TODAY I=12345          ! This is a comment. /
X(1)=12345, X(3:4)=2*1.5, I=6,
P="!ISN'T_BOB'S", Z=(123,0)/
```

### End of Fortran 95

### IBM Extension

An example of a **NAMelist** comment when you specify **NAMelist=OLD**. The comment appears after the value separator space.

```
&TODAY I=12345,           ! This is a comment.  
X(1)=12345, X(3:4)=2*1.5, I=6,  
P="!ISN'T_BOB'S", Z=(123,0) &END
```

### End of IBM Extension

## Namelist output

The **WRITE** statement outputs data from the *variable\_name\_list* in a **NAMelist** statement according to data type. This data can be read using namelist input except for non-delimited character data.

You must not specify a single long character variable for namelist output.

Each output record that is not continuing a delimited character constant from a previous record begins with a blank character that provides carriage control.

The output data fields become large enough to contain all significant digits, as shown in the *Width of a Written Field* table.

The values of a complete array output in column-major order.

If the length of an array element is not sufficient to hold the data, you must specify an array with more than three elements.

### IBM Extension

A **WRITE** statement with a *variable\_name\_list* produces a minimum of three output records:

- One record containing the namelist name.
- One or more records containing the output data items.
- One record containing a slash to terminate output.

To output namelist data to an internal file, the file must be a character array containing at least three elements. If you use the **WRITE** statement to transfer data to an internal file, the character array can require more than three elements.

### End of IBM Extension

You can delimit character data using the **DELIM=** specifier on the **OPEN** or **READ** statements.

## Namelist character output

The output of character constants can change depending on the **DELIM=** specifier on the **OPEN** or **READ** statements.

For character constants in a file opened without a **DELIM=** specifier, or with a **DELIM=NONE**:

- Values are non-delimited by apostrophes or quotation marks.
- Value separators do not occur between values.

- Each internal apostrophe or double quotation mark outputs as one apostrophe or quotation mark.
- XL Fortran inserts a blank character for carriage control at the beginning of any record that continues a character constant from the preceding record.

Nondelimited character data that has been written must not be read as character data.

Double quotation marks delimit character constants in a file opened with **DELIM=QUOTE**, with a value separator preceding and following each constant. Each internal quote outputs as two contiguous quotation marks.

Apostrophes delimit character constants in a file opened with **DELIM=APOSTROPHE** with a value separator preceding and following each constant. Each internal apostrophe outputs as two contiguous apostrophes.

### Rules for namelist output

You must not specify a single character variable to output namelist data to an internal file, even if it is large enough to hold all of the data.

If you do not specify the **NAMELIST** run-time option, or you specify **NAMELIST=NEW**, the namelist group name and namelist item names output in uppercase.

---

#### IBM Extension

---

If you specify **NAMELIST=OLD** at run-time:

- The namelist group name and namelist item names output in lower case.
- An **&END** terminates the output record.

If you specify **NAMELIST=OLD** at run-time and do not use the **DELIM=** specifier on an **OPEN** or **READ** statement:

- Apostrophes delimit character data
- Apostrophes delimit non-delimited character strings. A comma separator occurs between each character string.
- If a record starts with the continuation of a character string from the previous record, blanks are not added to the beginning of that record.

If you use the **-qmixed** compiler option, the namelist group name is case sensitive, regardless of the value of the **NAMELIST** run-time option.

To restrict namelist output records to a given width, use the **RECL=** specifier on the **OPEN** statement, or the **NLWIDTH** run-time option.

By default all output items for external files appear in a single output record. To have the record output on separate lines, use the **RECL=** specifier on the **OPEN** statement, or the **NLWIDTH** run-time option.

If decimal comma mode is in effect, a semicolon acts as a value separator instead of a comma.

---

End of IBM Extension

---

## Example of namelist output data

```
TYPE PERSON
  INTEGER P_AGE
  CHARACTER(20) P_NAME
END TYPE PERSON
TYPE(PERSON) SMITH
NAMELIST /NL1/ I,J,C,SMITH
CHARACTER(5) :: C='BACON'
INTEGER I,J
I=12046
J=12047
SMITH=PERSON(20,'John Smith')
WRITE(6,NL1)
END
```

After execution of the **WRITE** statement with **NAMELIST=NEW**, the output data is:

```
      1      2      3      4
1...+....0....+....0....+....0....+....0
&NL1
I=12046, J=12047, C=BACON, SMITH=20, John Smith
/
```

### IBM Extension

After execution of the **WRITE** statement with **NAMELIST=OLD**, the output data is:

```
      1      2      3      4
1...+....0....+....0....+....0....+....0
&n11
i=12046, j=12047, c='BACON', smith=20, 'John Smith      '
&end
```

### End of IBM Extension





## Chapter 11. Statements and attributes

This section provides an alphabetical reference to all XL Fortran statements. The section for each statement is organized to help you readily access the syntax and rules, and points to the structure and uses of the statement.

The following table lists the statements, and shows which ones are executable, which ones are *specification\_part* statements, and which ones can be used as the terminal statement of a **DO** or **DO WHILE** construct.

Table 31. Statements table

Statement Name	Executable Statement	Specification Statement	Terminal Statement
ABSTRACT <b>3</b>		X	
ALLOCATABLE <b>3</b>		X	
ALLOCATE	X		X
ASSIGN			X
ASSOCIATE <b>3</b>	X		
ASYNCHRONOUS <b>3</b>		X	
AUTOMATIC <b>1</b>		X	
BACKSPACE	X		X
BIND <b>3</b>		X	
BLOCK DATA			
BYTE <b>1</b>		X	
CALL	X		X
CLASS <b>3</b>		X	
CASE	X		
CHARACTER		X	
CLOSE	X		X
COMMON		X	
COMPLEX		X	
CONTAINS			
CONTINUE	X		X
CYCLE	X		
DATA		X	
DEALLOCATE	X		X
Derived Type			
DIMENSION		X	
DO	X		
DO WHILE	X		
DOUBLE COMPLEX <b>1</b>		X	

Table 31. Statements table (continued)

Statement Name	Executable Statement	Specification Statement	Terminal Statement
DOUBLE PRECISION		X	
ELSE	X		
ELSE IF	X		
ELSEWHERE	X		
END	X		
END ASSOCIATE <b>3</b>	X		
END BLOCK DATA			
END DO	X		X
END ENUM <b>3</b>		X	
END IF	X		
END FORALL <b>2</b>	X		
END FUNCTION	X		
END INTERFACE		X	
END MAP <b>1</b>		X	
END MODULE			
END PROGRAM	X		
END SELECT	X		
END SUBROUTINE	X		
END STRUCTURE <b>1</b>		X	
END TYPE		X	
END UNION <b>1</b>		X	
END WHERE	X		
ENDFILE	X		X
ENTRY		X	
ENUM <b>3</b>		X	
ENUMERATOR <b>3</b>		X	
EQUIVALENCE		X	
EXIT	X		
EXTERNAL		X	
FLUSH <b>3</b>	X		X
FORALL <b>2</b>	X		X
FORMAT		X	
FUNCTION			
GO TO (Assigned)	X		
GO TO (Computed)	X		X
GO TO (Unconditional)	X		

Table 31. Statements table (continued)

Statement Name	Executable Statement	Specification Statement	Terminal Statement
IF (Block)	X		
IF (Arithmetic)	X		
IF (Logical)	X		X
IMPLICIT		X	
IMPORT <b>3</b>		X	
INQUIRE	X		X
INTEGER		X	
INTENT		X	
INTERFACE		X	
INTRINSIC		X	
LOGICAL		X	
MAP <b>1</b>		X	
MODULE			
MODULE PROCEDURE		X	
NAMelist		X	
NULLIFY	X		X
OPEN	X		X
OPTIONAL		X	
PARAMETER		X	
PAUSE	X		X
POINTER (Fortran 90)		X	
POINTER (integer) <b>1</b>		X	
PRINT	X		X
PRIVATE		X	
PROCEDURE <b>3</b>		X	
PROGRAM			
PROTECTED <b>3</b>		X	
PUBLIC		X	
READ	X		X
REAL		X	
RECORD		X	
RETURN	X		
REWIND	X		X
SAVE		X	
SELECT CASE	X		
SELECT TYPE <b>3</b>	X		
SEQUENCE		X	

Table 31. Statements table (continued)

Statement Name	Executable Statement	Specification Statement	Terminal Statement
Statement Function		X	
STATIC <b>1</b>		X	
STOP	X		
SUBROUTINE			
STRUCTURE <b>1</b>		X	
TARGET		X	
TYPE		X	
Type Declaration		X	
Type Guard <b>3</b>	X		
UNION <b>1</b>		X	
USE		X	
VALUE <b>1</b>		X	
VECTOR <b>1</b>		X	
VIRTUAL <b>1</b>		X	
VOLATILE <b>3</b>		X	
WAIT <b>1</b>	X		X
WHERE	X		X
WRITE	X		X

**Notes:**

1. IBM Extension.
2. Fortran 95.
3. Fortran 2003.

Assignment and pointer assignment statements are discussed in Chapter 6, “Expressions and assignment,” on page 93. Both statements are executable and can serve as terminal statements.

## Attributes

Each attribute has a corresponding attribute specification statement, and the syntax diagram provided for the attribute illustrates this form. An entity can also acquire this attribute from a type declaration statement or, in some cases, through a default setting. For example, entity *A*, said to have the **PRIVATE** attribute, could have acquired the attribute in any of the following ways:

```

REAL, PRIVATE :: A      ! Type declaration statement
PRIVATE :: A           ! Attribute specification statement

MODULE X
  PRIVATE               ! Default setting
  REAL :: A
END MODULE

```

---

# ABSTRACT

Fortran 2003

## Purpose

The **ABSTRACT INTERFACE** statement is the first statement of an abstract interface block, which can specify procedure characteristics and dummy argument names without declaring a procedure with those characteristics.

## Syntax

```
▶▶—ABSTRACT INTERFACE—————▶▶
```

## Rules

If the interface statement is **ABSTRACT INTERFACE**, then the *function\_name* in the function statement or the *subroutine-name* in the subroutine statement shall not be the same as a keyword that specifies an intrinsic type.

As an **ABSTRACT INTERFACE** cannot have a generic specification, a **PROCEDURE** statement is not allowed in the **ABSTRACT INTERFACE** block.

A *proc-language-binding-spec* with a **NAME=** specifier shall not be specified in the function or subroutine statement of an abstract interface body.

## Examples

**ABSTRACT INTERFACE** can be used to declare the interface for deferred bindings.

```
ABSTRACT INTERFACE
  REAL FUNCTION PROC(A, B, C)
    REAL, INTENT (IN) :: A, B, C
  END FUNCTION
END INTERFACE
PROCEDURE (PROC), POINTER :: P => NULL()! P is declared to be a pointer that is initially
! null with the same interface as procedure PROC.
```

P can point to any external procedure or module procedure as long as it has the same interface as *PROC*.

## Related information

- “Abstract interface” on page 169
- “INTERFACE” on page 389

---

End of Fortran 2003

# ALLOCATABLE

## Purpose

The **ALLOCATABLE** attribute allows you to declare an allocatable object. You can dynamically allocate the storage space of these objects by executing an **ALLOCATE** statement or by a derived-type assignment statement. If the object is an array, it is a deferred-shape array.

## Syntax

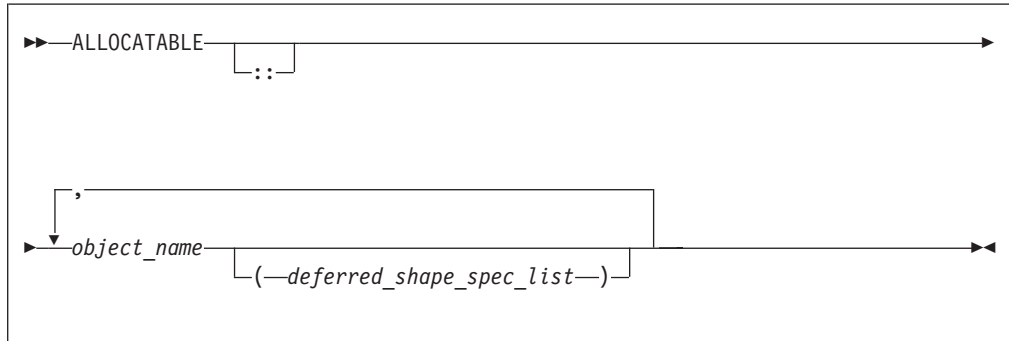

*object\_name*      The name of an allocatable object.

*deferred\_shape\_spec*  
A colon, where each colon represents a dimension

## Rules

The object must not be a pointee.

If the object is an array you specify elsewhere in the scoping unit with the **DIMENSION** attribute, the array specification must be a *deferred\_shape\_spec*.

Table 32. Attributes compatible with the **ALLOCATABLE** attribute

• ASYNCHRONOUS	• PRIVATE	• STATIC
• AUTOMATIC	• PROTECTED	• TARGET
• DIMENSION	• PUBLIC	• VOLATILE
• INTENT	• SAVE	
• OPTIONAL		

## Examples

```
REAL, ALLOCATABLE :: A(:,:) ! Two-dimensional array A declared  
! but no space yet allocated  
READ (5,*) I,J  
ALLOCATE (A(I,J))  
END
```

## Related information

- “Allocatable arrays” on page 77
- “ALLOCATED(X)” on page 541
- “ALLOCATE” on page 275

- “DEALLOCATE” on page 318
- “Allocation status” on page 26
- “Deferred-shape arrays” on page 76
- “Allocatable objects as dummy arguments” on page 190
- “Allocatable components” on page 55

---

## ALLOCATE

### Purpose

The **ALLOCATE** statement dynamically provides storage for pointer targets and allocatable objects.

### Syntax

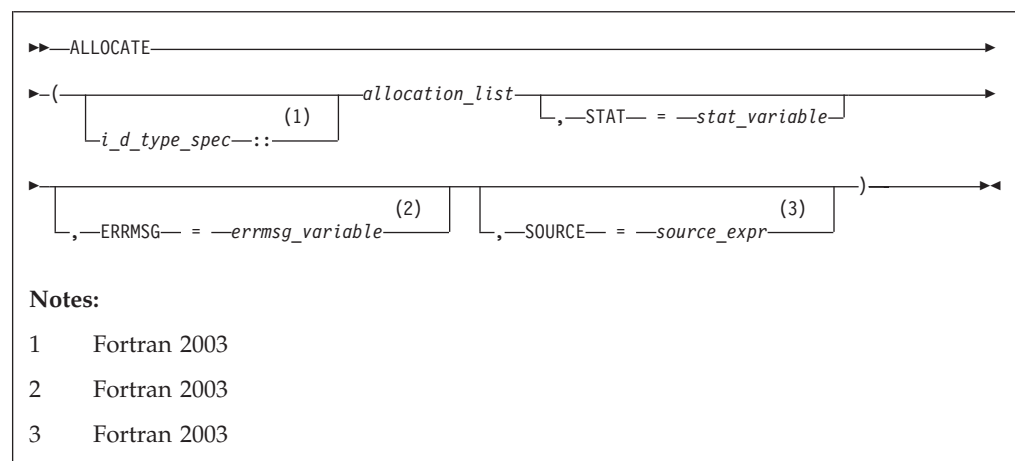

*stat\_variable*

A scalar integer variable.

---

**Fortran 2003**

---

*errmsg\_variable*

A scalar character variable.

*source\_expr*

An expression which is scalar or has the same rank as *allocate\_object*.

*i\_d\_type\_spec*

Is an *intrinsic\_type\_spec* or *derived\_type\_spec*. See “Type Declaration” on page 461 for a list of possible type specifications.

---

**End of Fortran 2003**

---

*allocation\_list*

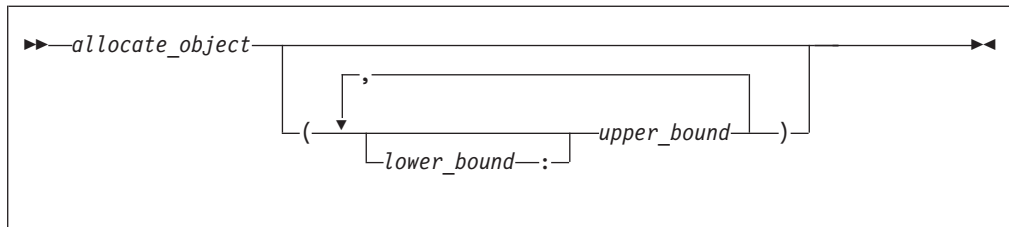

*allocate\_object*

A variable name or structure component that must be a data pointer or an allocatable object.

*lower\_bound, upper\_bound*

are each scalar integer expressions

## Rules

Execution of an **ALLOCATE** statement for a pointer causes the pointer to become associated with the target allocated. For an allocatable object, the object becomes definable.

The number of dimensions specified (i.e., the number of upper bounds in *allocation*) must be equal to the rank of *allocate\_object*. When an **ALLOCATE** statement is executed for an array, the values of the bounds are determined at that time. Subsequent redefinition or undefinition of any entities in the bound expressions does not affect the array specification. Any lower bound, if omitted, is assigned a default value of 1. If any lower bound value exceeds the corresponding upper bound value, that dimension has an extent of 0 and *allocate\_object* is zero-sized.

### Fortran 2003

If you allocate a polymorphic *allocate\_object* using *i\_d\_type\_spec*, allocation of the object occurs with the dynamic type and type parameters you specify. If you specify *source\_expr*, the polymorphic *allocate\_object* has the same dynamic type and type parameters as the *source\_expr*. Otherwise the *allocation\_object* has the same dynamic type as the declared type.

If any *allocate\_object* is unlimited polymorphic or has deferred type parameters, either *i\_d\_type\_spec* or **SOURCE=** must appear. If an *i\_d\_type\_spec* appears, it must specify a type with which each *allocate\_object* is type-compatible. If **SOURCE=** appears, *i\_d\_type\_spec* must not appear, and *allocation\_list* can only contain one *allocate\_object*, which must be type-compatible with *source\_expr*.

Any *allocate\_object* or a specified bound of an *allocate\_object* must not depend on the value of *stat\_variable* or *errmsg\_variable*, or on the value, bounds, length type parameters, allocation status, or association status of any *allocate\_object* in the same **ALLOCATE** statement

*stat\_variable*, *source\_expr*, and *errmsg\_variable* must not be allocated within the **ALLOCATE** statement in which they appear. They also must not depend on the value, bounds, length type parameters, allocation status, or association status of any *allocate\_object* in the same **ALLOCATE** statement.

End of Fortran 2003



If the **STAT=** specifier is not present and an error condition occurs during execution of the statement, the program terminates. If the **STAT=** specifier is present, the *stat\_variable* is assigned one of the following values:

IBM Extension	
Stat value	Error condition
0	No error
1	Error in system routine attempting to do allocation
2	An invalid data object has been specified for allocation
3	Both error conditions 1 and 2 have occurred

End of IBM Extension

Fortran 2003

If an error condition occurs during execution of the **ALLOCATE** statement, an explanatory message is assigned to *errmsg\_variable*. If no such condition occurs, the value of *errmsg\_variable* is not changed.

End of Fortran 2003

Allocating an allocatable object that is already allocated causes an error condition in the **ALLOCATE** statement.

Pointer allocation creates an object that has the **TARGET** attribute. Additional pointers can be associated with this target (or a subobject of it) through pointer assignment. If you reallocate a pointer that is already associated with a target:

- A new target is created and the pointer becomes associated with this target
- Any previous association with the pointer is broken
- Any previous target that had been created by allocation and is not associated with any other pointers becomes inaccessible

When an object of derived type is created by an **ALLOCATE** statement, any allocatable ultimate components have an allocation status of not currently allocated.

Use the **ALLOCATED** intrinsic function to determine if an allocatable object is currently allocated. Use the **ASSOCIATED** intrinsic function to determine the association status of a pointer or whether a pointer is currently associated with a specified target.

## Examples

```
CHARACTER, POINTER :: P(:, :)
CHARACTER, TARGET :: C(4,4)
INTEGER, ALLOCATABLE, DIMENSION(:) :: A
P => C
N = 2; M = N
ALLOCATE (P(N,M),STAT=I)           ! P is no longer associated with C
N = 3                               ! Target array for P maintains 2X2 shape
IF (.NOT.ALLOCATED(A)) ALLOCATE (A(N**2))
END
```

The following is an example of an **ALLOCATE** statement in which the value and dynamic type are determined by reference to another object:

```
CLASS(*), ALLOCATABLE :: NEW
CLASS(*), POINTER :: OLD
! ...
ALLOCATE (NEW, SOURCE=OLD) ! Allocate NEW with the value and dynamic type of OLD
```

End of Fortran 2003

## Related information

- “ALLOCATABLE” on page 274
- “DEALLOCATE” on page 318
- “Allocation status” on page 26
- “Pointer association” on page 152
- “Deferred-shape arrays” on page 76
- “ALLOCATED(X)” on page 541
- “ASSOCIATED(POINTER, TARGET)” on page 545
- “Allocatable objects as dummy arguments” on page 190
- “Allocatable components” on page 55

---

## ASSIGN

### Purpose

The **ASSIGN** statement assigns a statement label to an integer variable.

### Syntax

```
▶▶—ASSIGN—stmt_label—TO—variable_name—◀◀
```

*stmt\_label*

specifies the statement label of an executable statement or a **FORMAT** statement in the scoping unit containing the **ASSIGN** statement

*variable\_name*

is the name of a scalar **INTEGER(4)** or **INTEGER(8)** variable

### Rules

A statement containing the designated statement label must appear in the same scoping unit as the **ASSIGN** statement.

- If the statement containing the statement label is an executable statement, you can use the label name in an assigned **GO TO** statement that is in the same scoping unit.
- If the statement containing the statement label is a **FORMAT** statement, you can use the label name as the format specifier in a **READ**, **WRITE**, or **PRINT** statement that is in the same scoping unit.

You can redefine an integer variable defined with a statement label value with the same or different statement label value or an integer value. However, you must define the variable with a statement label value before you reference it in an assigned **GO TO** statement or as a format identifier in an input/output statement.

The value of *variable\_name* is not the integer constant represented by the label itself, and you cannot use it as such.

**Fortran 95**

The **ASSIGN** statement has been deleted from Fortran 95 and higher.

**End of Fortran 95**

## Examples

```

ASSIGN 30 TO LABEL
NUM = 40
GO TO LABEL
NUM = 50           ! This statement is not executed
30  ASSIGN 1000 TO IFMT
    PRINT IFMT, NUM ! IFMT is the format specifier
1000 FORMAT(1X,I4)
END

```

## Related information

- “Statement labels” on page 7
- “GO TO (assigned)” on page 365
- “Deleted features” on page 818

# ASSOCIATE

**Fortran 2003**

## Purpose

An **ASSOCIATE** statement is the first statement in an **ASSOCIATE** construct. It establishes an association between each identifier and either a variable or the value of an expression.

## Syntax

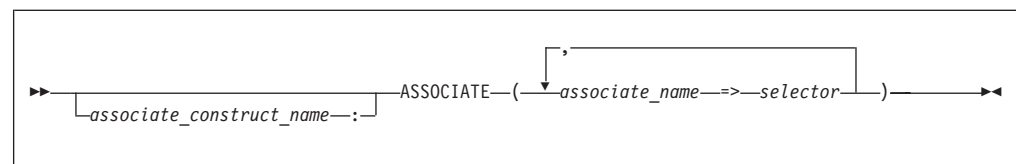

*associate\_construct\_name*  
is a name that identifies the **ASSOCIATE** construct

*associate\_name*  
is an identifier that once associated with the selector, becomes an associating entity.

*selector* is a variable or expression that once associated becomes the associated entity.

## Rules

If the *selector* is an expression or a variable with a vector subscript, the *associate\_name* is assigned the value of the expression or variable. That associating entity must not become redefined or undefined.

If the *selector* is a variable without a vector subscript, the *associate\_name* is associated with the data object specified by the *selector*. Whenever the value of the *associate\_name* (or the associating entity identified by the *associate\_name*) changes, the value of the variable changes with it.

If the *selector* has the **ALLOCATABLE** attribute, the associating entity does not have the **ALLOCATABLE** attribute. If the *selector* has the **POINTER** attribute, then the associating entity has the **TARGET** attribute. If the *selector* has the **TARGET**, **VOLATILE**, or **F2003 ASYNCHRONOUS F2003** attribute, the associating entity that is a variable has those attributes.

If the *selector* has the **OPTIONAL** attribute, it must be present.

An associating entity has the same type, type parameters, and rank as the *selector*. If the *selector* is polymorphic, the associating entity is polymorphic. If the *selector* is an array, the associating entity is an array with a lower bound for each dimension equal to the value of the intrinsic **LBOUND(selector)**. The upper bound for each dimension is equal to the lower bound plus the extent minus 1.

An *associate\_name* must be unique within an **ASSOCIATE** construct.

If the *associate\_construct\_name* appears on an **ASSOCIATE** construct statement, it must also appear on the corresponding **END ASSOCIATE** statement.

An **ASSOCIATE** construct statement must not appear within the dynamic or lexical extent of a parallel region.

## Examples

```
test_equiv: ASSOCIATE (a1 => 2, a2 => 40, a3 => 80)
  IF ((a1 * a2) .eq. a3) THEN
    PRINT *, "a3 = (a1 * a3)"
  END IF
END ASSOCIATE test_equiv

END
```

## Related information

"The scope of a name" on page 146

End of Fortran 2003

---

## ASYNCHRONOUS

Fortran 2003

## Purpose

The **ASYNCHRONOUS** statement specifies which variables may be associated with a pending I/O storage sequence while the scoping unit is in action.

## Syntax

```
▶▶—ASYNCHRONOUS—:—:—ioitem_list—◀◀
```

*ioitem* is a variable name

## Rules

The **ASYNCHRONOUS** attribute may be assigned implicitly by using a variable in an **ASYNCHRONOUS** I/O statement.

An object may have the **ASYNCHRONOUS** attribute in a particular scoping unit without having it in other scoping units.

If an object has the **ASYNCHRONOUS** attribute, then all of its subobjects have the **ASYNCHRONOUS** attribute.

An entity may have the **ASYNCHRONOUS** or **VOLATILE** attribute in the local scoping unit even if the associated module entity does not.

An accessed entity may have the **ASYNCHRONOUS** or **VOLATILE** attribute even if the host entity does not.

An associating entity has the **ASYNCHRONOUS** attribute if and only if the selector is a variable and has the **ASYNCHRONOUS** attribute.

## Examples

```
MODULE MOD
  INTEGER :: IOITEM
END MODULE
```

```
PROGRAM MAIN
```

```
  CALL SUB1()
  CALL SUB2()
END PROGRAM
```

```
SUBROUTINE SUB1() ! OPTIMIZATION MAY NOT BE PERFORMED
  USE MOD
  ASYNCHRONOUS :: IOITEM
  ....
END SUBROUTINE
```

```
SUBROUTINE SUB2() ! OPTIMIZATION MAY BE PERFORMED
  USE MOD
  ....
END SUBROUTINE
```

! OPTIMIZATION IS NOT POSSIBLE IN SUB2() IF MODULE MOD IS REWRITTEN AS FOLLOWS:

```
MODULE MOD
  INTEGER, ASYNCHRONOUS :: IOITEM
END MODULE
```

## Related information

- "Asynchronous Input/Output" on page 207
- "OPEN" on page 401
- "CLOSE" on page 301
- "INQUIRE" on page 375
- "READ" on page 428
- "WAIT" on page 477
- "WRITE" on page 483

End of Fortran 2003

---

## AUTOMATIC

IBM Extension

### Purpose

The **AUTOMATIC** attribute specifies that a variable has a storage class of automatic; that is, the variable is not defined once the procedure ends.

### Syntax

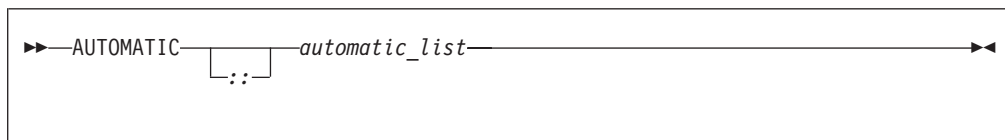

*automatic*

is a variable name or an array declarator with an explicit-shape specification list or a deferred-shape specification list

### Rules

If *automatic* is a function result it must not be of type character or of derived type.

Function results that are pointers or arrays, dummy arguments, statement functions, automatic objects, or pointees must not have the **AUTOMATIC** attribute. A variable with the **AUTOMATIC** attribute cannot be defined in the scoping unit of a module. A variable that is explicitly declared with the **AUTOMATIC** attribute cannot be a common block item.

A variable must not have the **AUTOMATIC** attribute specified more than once in the same scoping unit.

Any variable declared as **AUTOMATIC** within the scope of a thread's work will be local to that thread.

A variable with the **AUTOMATIC** attribute cannot be initialized by a **DATA** statement or a type declaration statement.

If *automatic* is a pointer, the **AUTOMATIC** attribute applies to the pointer itself, not to any target that is (or may become) associated with the pointer.

**Note:** An object with the **AUTOMATIC** attribute should not be confused with an automatic object. See “Automatic objects” on page 18.

**Attributes compatible with the AUTOMATIC attribute**

- ALLOCATABLE
- ASYNCHRONOUS
- DIMENSION
- POINTER
- TARGET
- VOLATILE

## Examples

```
CALL SUB
CONTAINS
  SUBROUTINE SUB
    INTEGER, AUTOMATIC :: VAR
    VAR = 12
  END SUBROUTINE
END
! VAR becomes undefined
```

## Related information

- “Storage classes for variables” on page 26
- **-qinitauto** option in the *XL Fortran Compiler Reference*

End of IBM Extension

# BACKSPACE

## Purpose

The **BACKSPACE** statement positions an external file connected for sequential access [F2003](#) or formatted stream access. [F2003](#)

Fortran 2003

Execution of a **BACKSPACE** statement performs a wait operation for any pending asynchronous data transfer operations for the specified unit.

End of Fortran 2003

## Syntax

```
▶▶—BACKSPACE—u—▶▶
      └──(—position_list—)──┘
```

*u* is an external unit identifier. The value of *u* must not be an asterisk or a Hollerith constant.

*position\_list*

is a list that must contain one unit specifier ([**UNIT=**]*u*) and can also contain one of each of the other valid specifiers:

**[UNIT=]** *u*

is a unit specifier in which *u* must be an external unit identifier whose value is not an asterisk. An external unit identifier refers to an external file that is represented by an integer expression, whose value is in the range 1 through 2147483647. If the optional characters **UNIT=** are omitted, *u* must be the first item in *position\_list*.

**ERR=** *stmt\_label*

is an error specifier that specifies the statement label of an executable statement in the same scoping unit to which control is to transfer in the case of an error. Coding the **ERR=** specifier suppresses error messages.

---

**Fortran 2003**

---

**IOMSG=** *iomsg\_variable*

is an input/output status specifier that specifies the message returned by the input/output operation. *iomsg\_variable* is a scalar default character variable. It must not be a use-associated nonpointer protected variable. When the input/output statement containing this specifier finishes execution, *iomsg\_variable* is defined as follows:

- If an error, end-of-file, or end-of-record condition occurs, the variable is assigned an explanatory message as if by assignment.
- If no such condition occurs, the value of the variable is unchanged.

---

**End of Fortran 2003**

---

**IOSTAT=** *ios*

is an input/output status specifier that specifies the status of the input/output operation. *ios* is a variable. When the **BACKSPACE** statement finishes executing, *ios* is defined with:

- A zero value if no error condition occurs
- A positive value if an error occurs.

## Rules

After the execution of a **BACKSPACE** statement, the file position is before the current record if a current record exists. If there is no current record, the file position is before the preceding record. If the file is at its initial point, file position remains unchanged.

You cannot backspace over records that were written using list-directed or namelist formatting.

For sequential access, if the preceding record is the endfile record, the file is positioned before the endfile record.

If the **ERR=** and **IOSTAT=** specifiers are set and an error is encountered, transfer is made to the statement specified by the **ERR=** specifier and a positive integer value is assigned to *ios*.

---

**IBM Extension**

---

If **IOSTAT=** and **ERR=** are not specified,

- The program stops if a severe error is encountered.



- The program continues to the next statement if a recoverable error is encountered and the **ERR\_RECOVERY** run-time option is set to **YES**. If the option is set to **NO**, the program stops.

End of IBM Extension

## Examples

```
BACKSPACE 15
BACKSPACE (UNIT=15,ERR=99)
...
99 PRINT *, "Unable to backspace file."
END
```

## Related information

- “Conditions and IOSTAT values” on page 214
- Chapter 9, “XL Fortran Input/Output,” on page 201
- *Setting run-time options in the XL Fortran Compiler Reference*

## BIND

Fortran 2003

### Purpose

The **BIND** attribute declares that a Fortran variable or common block is interoperable with the C programming language.

### Syntax

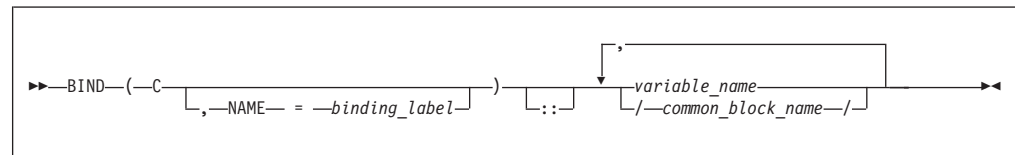

*binding\_label*

is a scalar character initialization expression

### Rules

This attribute specifies that a Fortran variable or common block is interoperable with a C entity with external linkage. Refer to “Interoperability of Variables” on page 744 and “Interoperability of common blocks” on page 744 for details.

If the **NAME=** specifier appears in a **BIND** statement, then only one *variable\_name* or *common\_block\_name* can appear.

If a **BIND** statement specifies a common block, then each variable of that common block must be of interoperable type and type parameters, and must not have the **POINTER** or **ALLOCATABLE** attribute.

Table 33. Attributes compatible with the BIND attribute

• ASYNCHRONOUS	• SAVE
• DIMENSION	• STATIC
• PRIVATE	• TARGET
• PROTECTED	• VOLATILE
• PUBLIC	

## Related information

- Chapter 17, “Language interoperability features,” on page 743
- “Interoperability of Variables” on page 744
- “Interoperability of common blocks” on page 744
- “ENTRY” on page 343
- “FUNCTION” on page 362
- “PROCEDURE declaration” on page 419
- “SUBROUTINE” on page 453
- “Derived Type” on page 320

End of Fortran 2003

---

## BLOCK DATA

### Purpose

A **BLOCK DATA** statement is the first statement in a block data program unit, which provides initial values for variables in named common blocks.

### Syntax

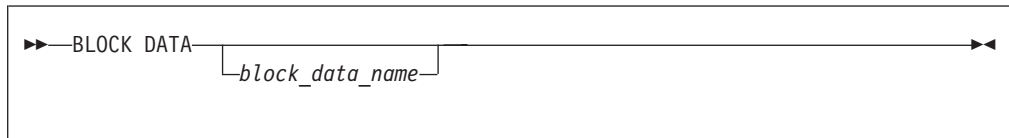

*block\_data\_name*

is the name of a block data program unit

### Rules

You can have more than one block data program unit in an executable program, but only one can be unnamed.

The name of the block data program unit, if given, must not be the same as an external subprogram, entry, main program, module, or common block in the executable program. It also must not be the same as a local entity in this program unit.

## Examples

```
BLOCK DATA ABC
  PARAMETER (I=10)
  DIMENSION Y(5)
  COMMON /L4/ Y
  DATA Y /5*I/
END BLOCK DATA ABC
```

## Related information

- “Block data program unit” on page 174
- “END” on page 335 for details on the **END BLOCK DATA** statement

---

## BYTE

### IBM Extension

## Purpose

The **BYTE** type declaration statement specifies the attributes of objects and functions of type byte. Each scalar object has a length of 1. Initial values can be assigned to objects.

## Syntax

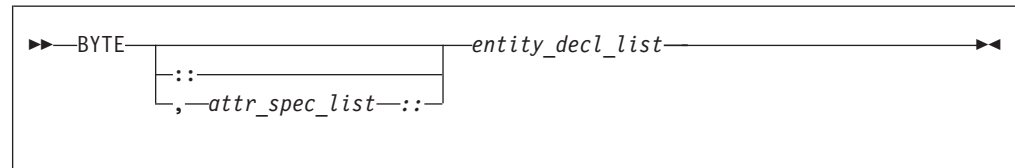

where:

<i>attr_spec</i>
<b>ALLOCATABLE</b>
<b>ASYNCHRONOUS</b>
<b>AUTOMATIC</b>
<b>BIND</b>
<b>DIMENSION</b> ( <i>array_spec</i> )
<b>EXTERNAL</b>
<b>INTENT</b> ( <i>intent_spec</i> )
<b>INTRINSIC</b>
<b>OPTIONAL</b>
<b>PARAMETER</b>
<b>POINTER</b>
<b>PRIVATE</b>
<b>PROTECTED</b>
<b>PUBLIC</b>
<b>SAVE</b>
<b>STATIC</b>
<b>TARGET</b>
<b>VALUE</b>
<b>VOLATILE</b>

*attr\_spec*

For detailed information on rules about a particular attribute, refer to the statement of the same name.

*intent\_spec*

is either **IN**, **OUT**, or **INOUT**

:: is the double colon separator. Use the double colon separator when you specify attributes, *=initialization\_expr*, or **=> NULL()**.

*array\_spec*

is a list of dimension bounds

*entity\_decl*

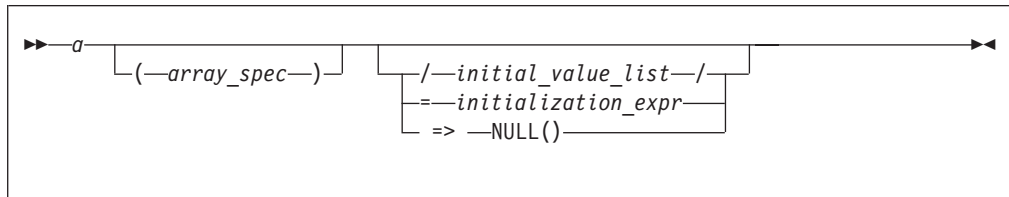

*a* is an object name or function name. *array\_spec* cannot be specified for a function with an implicit interface.

*initial\_value*

provides an initial value for the entity specified by the immediately preceding name

*initialization\_expr*

provides an initial value, by means of an initialization expression, for the entity specified by the immediately preceding name

**=> NULL()**

provides the initial value for the pointer object

## Rules

Within the context of a derived type definition:

- If **=>** appears in a component initialization, the **POINTER** attribute must appear in the *attr\_spec\_list*.
- If **=** appears in a component initialization, the **POINTER** attribute cannot appear in the component *attr\_spec\_list*.
- The compiler will evaluate *initialization\_expr* within the scoping unit of the type definition.

If **=>** appears for a variable, the object must have the **POINTER** attribute.

If *initialization\_expr* appears for a variable, the object cannot have the **POINTER** attribute.

Entities in type declaration statements are constrained by the rules of any attributes specified for the entities, as detailed in the corresponding attribute statements.

The type declaration statement overrides the implicit type rules in effect. You can use a type declaration statement that confirms the type of an intrinsic function. The

appearance of a generic or specific intrinsic function name in a type declaration statement does not cause the name to lose its intrinsic property.

An object cannot be initialized in a type declaration statement if it is a dummy argument, an allocatable object, a function result, an object in blank common, an integer pointer, an external name, an intrinsic name, or an automatic object. Nor can an object be initialized if it has the **AUTOMATIC** attribute. The object may be initialized if it appears in a named common block in a block data program unit or if it appears in a named common block in a module.

Fortran 95

In Fortran 95, a pointer can be initialized. Pointers can only be initialized by the use of `=> NULL()`.

End of Fortran 95

The specification expression of an *array\_spec* can be a nonconstant expression if the specification expression appears in an interface body or in the specification part of a subprogram. Any object being declared that uses this nonconstant expression and is not a dummy argument or a pointee is called an *automatic object*.

An attribute cannot be repeated in a given type declaration statement, nor can an entity be explicitly given the same attribute more than once in a scoping unit.

*initialization\_expr* must be specified if the statement contains the **PARAMETER** attribute. If *initialization\_expr* F95 or `NULL()` F95 is specified, and the entity you are declaring:

- is a variable, the variable is initially defined.

Fortran 95

- is a derived type component, the derived type has default initialization.

End of Fortran 95

*a* becomes defined with the value determined by *initialization\_expr*, in accordance with the rules for intrinsic assignment. If the entity is an array, its shape must be specified either in the type declaration statement or in a previous specification statement in the same scoping unit.

A variable or variable subobject cannot be initialized more than once. If *a* is a variable, the presence of *initialization\_expr* F95 or `NULL()` F95 implies that *a* is a saved object, except for an object in a named common block. The initialization of an object could affect the fundamental storage class of an object.

An *array\_spec* specified in the *entity\_decl* takes precedence over the *array\_spec* in the **DIMENSION** attribute.

An array function result that does not have the F2003 **ALLOCATABLE** or F2003 **POINTER** attribute must have an explicit-shape array specification.

If the entity declared is a function, it must not have an accessible explicit interface unless it is an intrinsic function.

If T or F, defined previously as the name of a constant, appears in a type declaration statement, it is no longer an abbreviated logical constant but the name of the named constant.

## Examples

```
BYTE, DIMENSION(4) :: X=(/1,2,3,4/)
```

## Related information

- “Byte” on page 44
- “Initialization expressions” on page 95
- “Determining Type” on page 17, for details on the implicit typing rules
- “Automatic objects” on page 18
- “Storage classes for variables” on page 26
- “DATA” on page 314, for details on initial values

End of IBM Extension

## CALL

### Purpose

The **CALL** statement invokes a subroutine to execute.

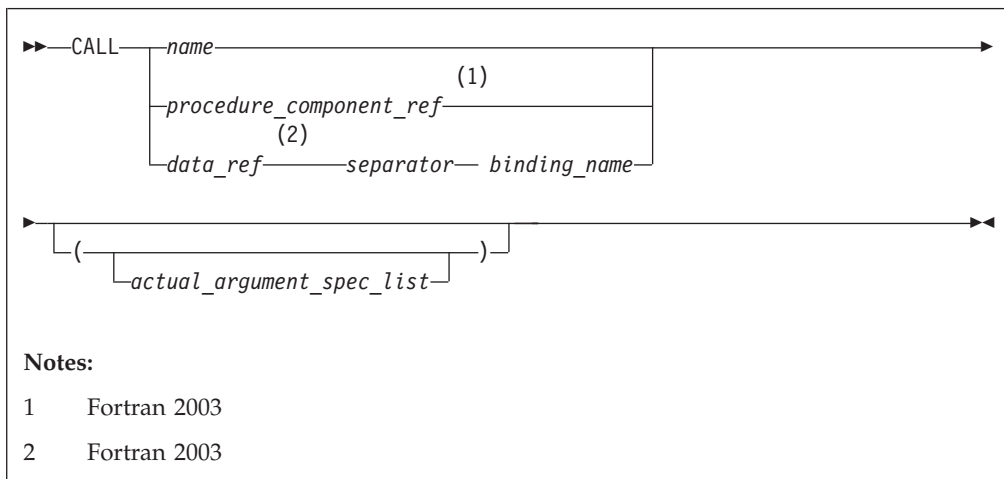

### Syntax



*name* The name of an internal, external, or module subroutine, an entry in an external or module subroutine, an intrinsic subroutine, a generic name, or a procedure pointer.

*procedure\_component\_ref*  
The name of a procedure pointer component of the declared type of *data\_ref*

*data\_ref*  
The name of an object of derived type

*separator*  
is % or  

*binding\_name*

is the name of a procedure binding of the declared type of *data\_ref*

## Rules

Executing a **CALL** statement results in the following order of events:

1. Actual arguments that are expressions are evaluated.
2. Actual arguments are associated with their corresponding dummy arguments.
3. Control transfers to the specified subroutine.
4. The subroutine is executed.
5. Control returns from the subroutine.

---

### Fortran 2003

---

A procedure pointer is a pointer that is associated with a procedure. Procedure pointers may have either an explicit or implicit interface and the interface may not be generic or elemental.

A procedure pointer component is a component of a derived type that has been declared to be a procedure pointer using the **PROCEDURE** statement.

If the *binding\_name* in a procedure designator is that of a *specific* procedure, the procedure referenced is the one identified by the binding with that name in the dynamic type of the *data\_ref*. If the *binding\_name* in a procedure designator is that of a *generic* procedure, the generic binding with that name in the declared type of the *data\_ref* is used to select a specific binding according to the following rules:

1. If the reference is consistent with one of the specific bindings of that generic binding, that specific binding is selected.
2. Otherwise, if the reference is consistent with an elemental reference to one of the specific bindings of that generic binding, that specific binding is selected.

The reference is to the procedure identified by the binding with the same name as the selected specific binding, in the dynamic type of the *data\_ref*.

---

### End of Fortran 2003

---

A subprogram can call itself recursively, directly or indirectly, if the subroutine statement specifies the **RECURSIVE** keyword.

If a **CALL** statement includes one or more alternate return specifiers among its arguments, control may be transferred to one of the statement labels indicated, depending on the action specified by the subroutine in the **RETURN** statement.

---

### IBM Extension

---

An external subprogram can also refer to itself directly or indirectly if the **-qrecur** compiler option is specified.

The argument list built-in functions **%VAL** and **%REF** are supplied to aid interlanguage calls by allowing arguments to be passed by value and by reference, respectively. They can only be references to non-Fortran procedures

---

### End of IBM Extension

---

The **VALUE** attribute also allows you to pass arguments by value.

## Examples

```

INTERFACE
  SUBROUTINE SUB3(D1,D2)
    REAL D1,D2
  END SUBROUTINE
END INTERFACE
ARG1=7 ; ARG2=8
CALL SUB3(D2=ARG2,D1=ARG1)    ! subroutine call with argument keywords
END

SUBROUTINE SUB3(F1,F2)
  REAL F1,F2,F3,F4
  F3 = F1/F2
  F4 = F1-F2
  PRINT *, F3, F4
END SUBROUTINE

```

## Related information

- “Recursion” on page 195
- “%VAL and %REF” on page 184
- “VALUE” on page 472
- “Actual argument specification” on page 180
- “Asterisks as dummy arguments” on page 193
- “Type-bound procedures” on page 58

---

## CASE

### Purpose

The **CASE** statement initiates a **CASE** statement block in a **CASE** construct, which has a concise syntax for selecting, at most, one of a number of statement blocks for execution.

### Syntax

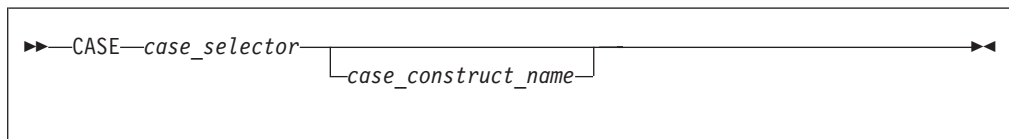

*case\_selector*



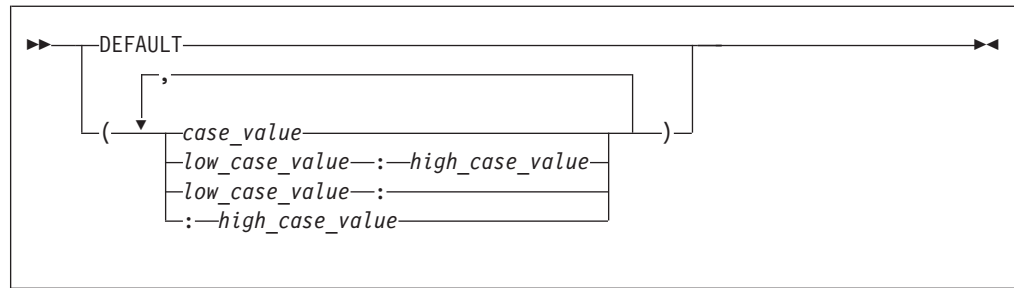

*case\_construct\_name*

Is a name that identifies the **CASE** construct.

*case\_value*

is a scalar initialization expression of type integer, character, or logical

*low\_case\_value, high\_case\_value*

are each scalar initialization expressions of type integer, character, or logical

## Rules

The case index, determined by the **SELECT CASE** statement, is compared to each *case\_selector* in a **CASE** statement. When a match occurs, the *stmt\_block* associated with that **CASE** statement is executed. If no match occurs, no *stmt\_block* is executed. No two case value ranges can overlap.

A match is determined as follows:

*case\_value*

DATA TYPE: integer, character or logical

MATCH for integer and character:  $case\ index = case\_value$

MATCH for logical:  $case\ index .EQV. case\_value$  is true

*low\_case\_value : high\_case\_value*

DATA TYPE: integer or character

MATCH:  $low\_case\_value \leq case\ index \leq high\_case\_value$

*low\_case\_value :*

DATA TYPE: integer or character

MATCH:  $low\_case\_value \leq case\ index$

*: high\_case\_value*

DATA TYPE: integer or character

MATCH:  $case\ index \leq high\_case\_value$

**DEFAULT**

DATA TYPE: not applicable

MATCH: if no other match occurs.

There must be only one match. If there is a match, the statement block associated with the matched *case\_selector* is executed, completing execution of the case construct. If there is no match, execution of the case construct is complete.

If the *case\_construct\_name* is specified, it must match the name specified on the **SELECT CASE** and **END SELECT** statements.

**DEFAULT** is the default *case\_selector*. Only one of the **CASE** statements may have **DEFAULT** as the *case\_selector*.

Each case value must be of the same data type as the *case\_expr*, as defined in the **SELECT CASE** statement. If any typeless constants or **BYTE** named constants are encountered in the *case\_selectors*, they are converted to the data type of the *case\_expr*.

When the *case\_expr* and the case values are of type character, they can have different lengths. If you specify the **-qctyp1ss** compiler option, a character constant expression used as the *case\_expr* remains as type character. The character constant expression will not be treated as a typeless constant.

## Examples

```
ZERO: SELECT CASE(N)

      CASE DEFAULT ZERO           ! Default CASE statement for
                                  ! CASE construct ZERO

      OTHER: SELECT CASE(N)
        CASE(:-1)                 ! CASE statement for CASE
                                  ! construct OTHER

          SIGNUM = -1
          CASE(1:) OTHER
            SIGNUM = 1
          END SELECT OTHER
      CASE (0)
        SIGNUM = 0

END SELECT ZERO
```

## Related information

- “SELECT CASE construct” on page 137
- “SELECT CASE” on page 446
- “END (Construct)” on page 336, for details on the **END SELECT** statement

---

## CHARACTER

### Purpose

A **CHARACTER** type declaration statement specifies the kind, length, and attributes of objects and functions of type character. You can assign initial values to objects.

### Syntax

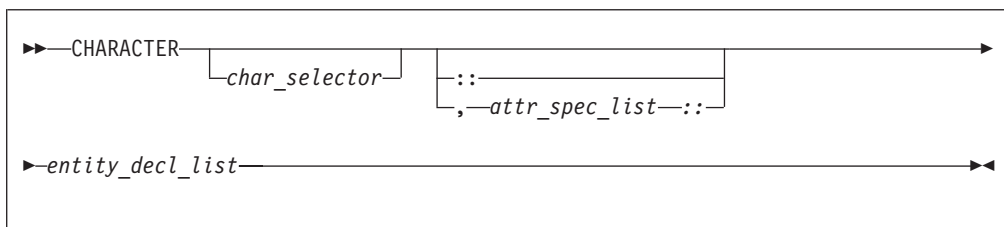

where:

<i>attr_spec</i>
ALLOCATABLE ASYNCHRONOUS AUTOMATIC BIND DIMENSION ( <i>array_spec</i> ) EXTERNAL INTENT ( <i>intent_spec</i> ) INTRINSIC OPTIONAL PARAMETER POINTER PRIVATE PROTECTED PUBLIC SAVE STATIC TARGET VALUE VOLATILE

*char\_selector*

specifies the character length.

<b>IBM Extension</b>
<p>This is the number of characters between 0 and 256 MB. Values exceeding 256 MB are set to 256 MB in 32 bit, while negative values result in a length of zero. If not specified, the default length is 1. The kind type parameter, if specified, must be 1, which specifies the ASCII character representation.</p>
<b>End of IBM Extension</b>

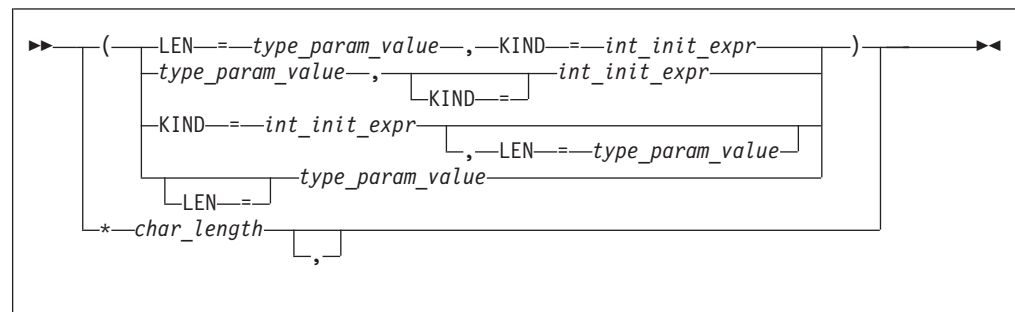

*type\_param\_value*

is a specification expression, an asterisk (\*) or a colon

*int\_init\_expr*

is a scalar integer initialization expression that must evaluate to 1

*char\_length*

is either a scalar integer literal constant (which cannot specify a kind type parameter) or a *type\_param\_value* enclosed in parentheses

*attr\_spec*

For detailed information on rules about a particular attribute, refer to the statement of the same name.

*intent\_spec*

is either **IN**, **OUT**, or **INOUT**

:: is the double colon separator. Use the double colon separator when you specify attributes, =*initialization\_expr*, **F95** or => **NULL()** **F95**.

*array\_spec*

is a list of dimension bounds.

*entity\_decl*

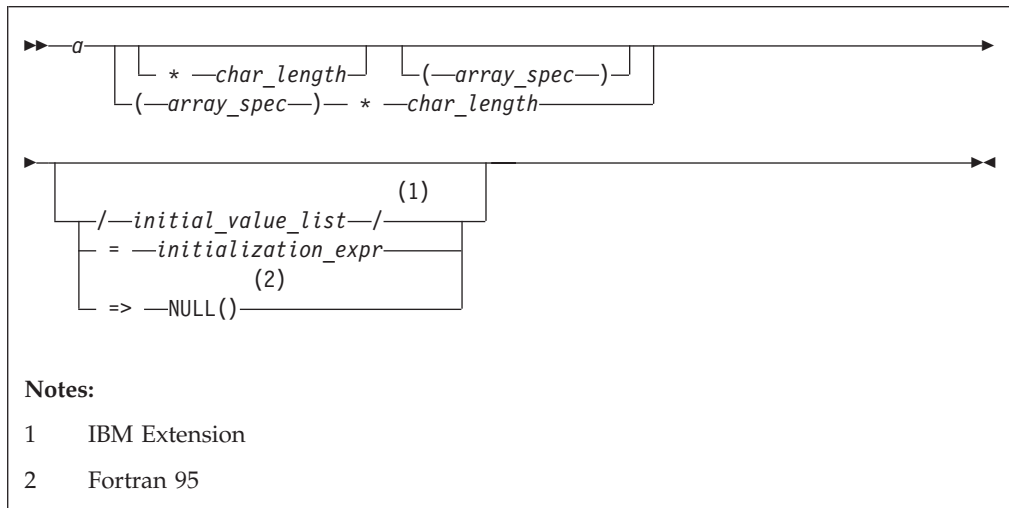

*a* is an object name or function name. *array\_spec* cannot be specified for a function with an implicit interface.

**IBM Extension**

*initial\_value*

provides an initial value for the entity specified by the immediately preceding name

**End of IBM Extension**

*initialization\_expr*

provides an initial value, by means of an initialization expression, for the entity specified by the immediately preceding name

**Fortran 95**

**=> NULL()**

provides the initial value for the pointer object

**End of Fortran 95**

## Rules

### Fortran 95

Within the context of a derived type definition:

- If => appears in a component initialization, the **POINTER** attribute must appear in the *attr\_spec\_list*.
- If = appears in a component initialization, the **POINTER** attribute cannot appear in the component *attr\_spec\_list*.
- The compiler will evaluate *initialization\_expr* within the scoping unit of the type definition.

If => appears for a variable, the object must have the **POINTER** attribute.

### End of Fortran 95

If *initialization\_expr* appears for a variable, the object cannot have the **POINTER** attribute.

Entities in type declaration statements are constrained by the rules of any attributes specified for the entities, as detailed in the corresponding attribute statements.

The type declaration statement overrides the implicit type rules in effect. You can use a type declaration statement that confirms the type of an intrinsic function. The appearance of a generic or specific intrinsic function name in a type declaration statement does not cause the name to lose its intrinsic property.

An object must not be initially defined in a type declaration statement if it is a dummy argument, an allocatable object, a pointer, a function result, an object in blank common, an integer pointer, an external name, an intrinsic name, or an automatic object. Nor can an object be initialized if it has the **AUTOMATIC** attribute. The object may be initialized if:

- it appears in a named common block in a block data program unit.

### IBM Extension

- if it appears in a named common block in a module.

### End of IBM Extension

### Fortran 95

In Fortran 95, a pointer can be initialized. Pointers can only be initialized by the use of => **NULL()**.

### End of Fortran 95

The specification expression of a *type\_param\_value* or an *array\_spec* can be a nonconstant expression if the specification expression appears in an interface body or in the specification part of a subprogram. Any object being declared that uses this nonconstant expression and is not a dummy argument or a pointee is called an *automatic object*.

An attribute cannot be repeated in a given type declaration statement, nor can an entity be explicitly given the same attribute more than once in a scoping unit.

*initialization\_expr* must be specified if the statement contains the **PARAMETER** attribute. If *initialization\_expr* F95 or **NULL0** F95 is specified, and the entity you are declaring:

- is a variable, the variable is initially defined.

Fortran 95

- is a derived type component, the derived type has default initialization.

End of Fortran 95

*a* becomes defined with the value determined by *initialization\_expr*, in accordance with the rules for intrinsic assignment. If the entity is an array, its shape must be specified either in the type declaration statement or in a previous specification statement in the same scoping unit.

A variable or variable subobject cannot be initialized more than once. If *a* is a variable, the presence of *initialization\_expr* F95 or **NULL0** F95 implies that *a* is a saved object, except for an object in a named common block. The initialization of an object could affect the fundamental storage class of an object.

An *array\_spec* specified in an *entity\_decl* takes precedence over the *array\_spec* in the **DIMENSION** attribute. A *char\_length* specified in an *entity\_decl* takes precedence over any length specified in *char\_selector*.

An array function result that does not have the **POINTER** attribute must have an explicit-shape array specification.

If the entity declared is a function, it must not have an accessible explicit interface unless it is an intrinsic function.

IBM Extension

If *T* or *F*, defined previously as the name of a constant, appears in a type declaration statement, it is no longer an abbreviated logical constant but the name of the named constant.

End of IBM Extension

The optional comma after *char\_length* in a **CHARACTER** type declaration statement is permitted only if no double colon separator (::) appears in the statement.

Fortran 2003

If the **CHARACTER** type declaration statement specifies a length of a colon, the length type parameter is a *deferred type parameter*. An entity or component with a deferred type parameter must specify the **ALLOCATABLE** or **POINTER** attribute. A deferred type parameter is a length type parameter whose value can change during the execution of the program.

End of Fortran 2003

If the **CHARACTER** type declaration statement is in the scope of a module, block data program unit, or main program, and you specify the length of the entity as an inherited length, the entity must be the name of a named character constant. The character constant assumes the length of its corresponding expression defined by the **PARAMETER** attribute.

If the **CHARACTER** type declaration statement is in the scope of a procedure and the length of the entity is inherited, the entity name must be the name of a dummy argument or a named character constant. If the statement is in the scope of an external function, it can also be the function or entry name in a **FUNCTION** or **ENTRY** statement in the same program unit. If the entity name is the name of a dummy argument, the dummy argument assumes the length of the associated actual argument for each reference to the procedure. If the entity name is the name of a character constant, the character constant assumes the length of its corresponding expression defined by the **PARAMETER** attribute. If the entity name is a function or entry name, the entity assumes the length specified in the calling scoping unit.

The length of a character function can be a specification expression (which must be a constant expression if the function type is not declared in an interface block) or it is a colon, or an asterisk, indicating the length of a dummy procedure name. The length cannot be an asterisk if the function is an internal or module function, if it is recursive, or if it returns array or pointer values.

## Examples

```
CHARACTER(KIND=1,LEN=6) APPLES /'APPLES'/
CHARACTER(7), TARGET :: ORANGES = 'ORANGES'
I=7
CALL TEST(APPLES,I)
CONTAINS
  SUBROUTINE TEST(VARBL,I)
    CHARACTER*(*), OPTIONAL :: VARBL ! VARBL inherits a length of 6
    CHARACTER(I) :: RUNTIME ! Automatic object with length of 7
  END SUBROUTINE
END
```

## Related information

- “Character” on page 41
- “Initialization expressions” on page 95
- “Determining Type” on page 17 for details on the implicit typing rules
- “Array declarators” on page 73
- “Automatic objects” on page 18
- “Storage classes for variables” on page 26
- “DATA” on page 314, for details on initial values

---

## CLASS

Fortran 2003

### Purpose

A **CLASS** type declaration statement specifies the declared type and attributes of objects of derived type. Initial values can be assigned to objects.

## Syntax

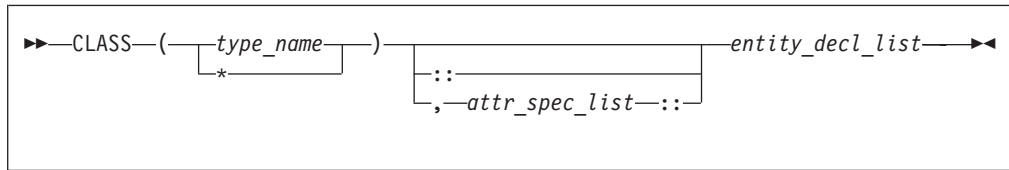

*type\_name*

is the name of an extensible derived type

*attr\_spec*

For more information, see "TYPE" on page 457

*entity\_decl*

For more information, see "TYPE" on page 457

## Rules

The rules for the **TYPE** type declaration and **CLASS** type declaration are similar; for further information, see "TYPE" on page 457.

The following rules are unique to **CLASS** type declarations:

- The **CLASS** type specifier is used to declare a polymorphic object. The *type\_name* is the declared type of a polymorphic object.
- Use the **CLASS(\*)** specifier to declare an unlimited polymorphic object. An unlimited polymorphic entity is not declared to have a type, and is not considered to have the same declared type as any other entity, including another unlimited polymorphic entity.
- An entity declared with the **CLASS** keyword must be a dummy argument or have the **ALLOCATABLE** or **POINTER** attribute. Also, dummy arguments declared with the **CLASS** keyword must not have the value attribute:

## Examples

```
program sClass

  type base
    integer::i
  end type

  type,extends(base)::child
    integer::j
  end type

  type(child),target::child1=child(4,6)
  type(base), target::base1=base(7)
  ! declare an item that could contain any extensible derived type
  ! or intrinsic type
  class(*),allocatable::anything

  ! declare basePtr as a polymorphic item with declared type base,
  ! could have run time type of base or child
  class(base),pointer::basePtr

  ! set basePtr to point to an item of type child
  basePtr=>child1
  call printAny(basePtr)

  ! set basePtr to point to an item of type base
```



```

basePtr=>base1
call printAny(basePtr)

! allocate an integer item
allocate(anyThing, source=base1%i)
call printAny(anyThing)

contains

subroutine printAny(printItem)
! declare a dummy arg of unlimited polymorphic, can point
! to any extensible derived type or intrinsic type
class(*)::printItem

select type(item=>printItem)
type is (base)
print*, ' base item is ', item

type is (child)
print*, ' child item is ', item

type is (integer)
print*, ' integer item is ', item
end select
end subroutine
end program

```

The output of the program is:

```

child item is 4 6
base item is 7
integer item is 7

```

## Related information

- “Polymorphic entities” on page 18

End of Fortran 2003

## CLOSE

### Purpose

The **CLOSE** statement disconnects an external file from a unit.

Fortran 2003

Execution of a **CLOSE** statement performs a wait operation for any pending asynchronous data transfer operations for the specified unit.

End of Fortran 2003

### Syntax

```

▶▶—CLOSE—(—close_list—)————▶▶

```

*close\_list*

is a list that must contain one unit specifier (**UNIT=*u***) and can also contain one of each of the other valid specifiers. The valid specifiers are:

**[UNIT=]** *u*

is a unit specifier in which *u* must be an external unit identifier whose value is not an asterisk. An external unit identifier refers to an external file that is represented by an integer expression, whose value is in the range 1 through 2147483647. If the optional characters **UNIT=** are omitted, *u* must be the first item in *close\_list*.

**ERR=** *stmt\_label*

is an error specifier that specifies the statement label of an executable statement in the same scoping unit to which control is to transfer in the case of an error. Coding the **ERR=** specifier suppresses error messages.

---

**Fortran 2003**

---

**IOMSG=** *iormsg\_variable*

is an input/output status specifier that specifies the message returned by the input/output operation. *iormsg\_variable* is a scalar default character variable. It must not be a use-associated nonpointer protected variable. When the input/output statement containing this specifier finishes execution, *iormsg\_variable* is defined as follows:

- If an error, end-of-file, or end-of-record condition occurs, the variable is assigned an explanatory message as if by assignment.
- If no such condition occurs, the value of the variable is unchanged.

---

**End of Fortran 2003**

---

**IOSTAT=** *ios*

is an input/output status specifier that specifies the status of the input/output operation. *ios* is an integer variable. When the input/output statement containing this specifier finishes executing, *ios* is defined with:

- A zero value if no error condition occurs
- A positive value if an error occurs.

**STATUS=** *char\_expr*

specifies the status of the file after it is closed. *char\_expr* is a scalar character expression whose value, when any trailing blanks are removed, is either **KEEP** or **DELETE**.

- If **KEEP** is specified for a file that exists, the file will continue to exist after the **CLOSE** statement. If **KEEP** is specified for a file that does not exist, the file will not exist after the **CLOSE** statement. **KEEP** must not be specified for a file whose status prior to executing the **CLOSE** statement is **SCRATCH**.
- If **DELETE** is specified, the file will not exist after the **CLOSE** statement.

The default is **DELETE** if the file status is **SCRATCH**; otherwise, the default is **KEEP**.

## Rules

A **CLOSE** statement that refers to a unit can occur in any program unit of an executable program and need not occur in the same scoping unit as the **OPEN** statement referring to that unit. You can specify a unit that does not exist or has no file connected; the **CLOSE** statement has no effect in this case.

▶ IBM Unit 0 cannot be closed. IBM ◀

When an executable program stops for reasons other than an error condition, all units that are connected are closed. Each unit is closed with the status **KEEP** unless the file status prior to completion was **SCRATCH**, in which case the unit is closed with the status **DELETE**. The effect is as though a **CLOSE** statement without a **STATUS=** specifier were executed on each connected unit.

If a preconnected unit is disconnected by a **CLOSE** statement, the rules of implicit opening apply if the unit is later specified in a **WRITE** statement (without having been explicitly opened).

## Examples

```
CLOSE(15)
CLOSE(UNIT=16,STATUS='DELETE')
```

## Related information

- “Units” on page 205
- “Conditions and IOSTAT values” on page 214
- “OPEN” on page 400

---

## COMMON

### Purpose

The **COMMON** statement specifies common blocks and their contents. A common block is a storage area that two or more scoping units can share, allowing them to define and reference the same data and to share storage units.

### Syntax

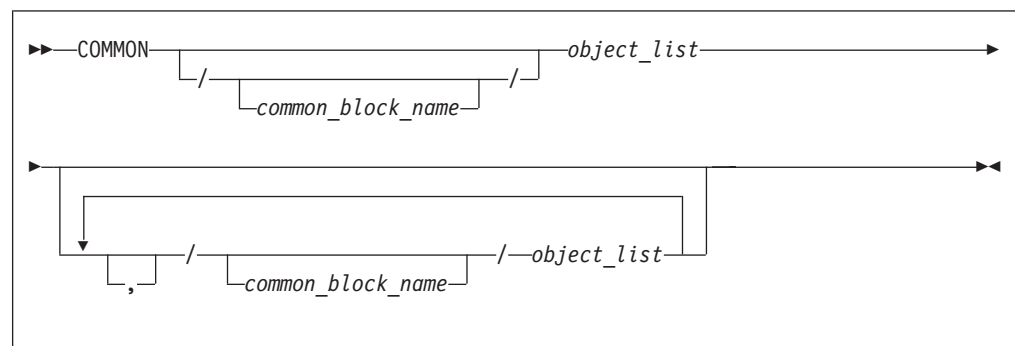

*object*

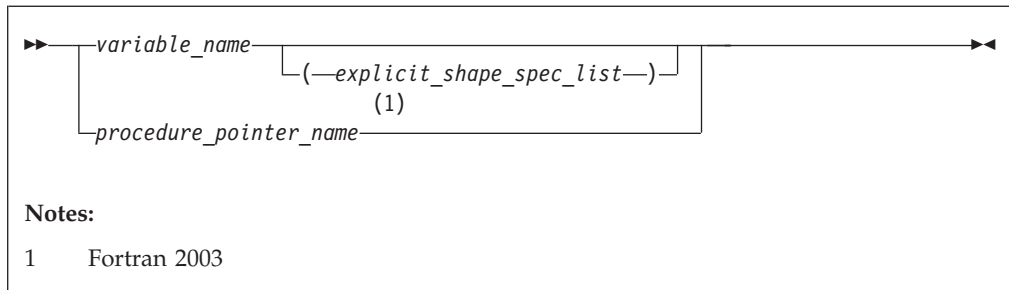

## Rules

*object* cannot refer to a dummy argument, automatic object, allocatable object, or an object of a derived type that has an allocatable ultimate component, pointee, function, function result, or entry to a procedure, or a variable with the **BIND** attribute. *object* cannot have the **STATIC** or **AUTOMATIC** attributes.

If an *explicit\_shape\_spec\_list* is present, *variable\_name* must not have the **POINTER** attribute. Each dimension bound must be a constant specification expression. This form specifies that *variable\_name* has the **DIMENSION** attribute.

### Fortran 2003

A given *variable\_name* or procedure pointer name can only appear once in all common block object lists within a scoping unit. Their names cannot be made accessible by use association.

### End of Fortran 2003

If *object* is of derived type, it must be a sequence derived type. Given a sequenced structure where all the ultimate components are nonpointers, and are all of character type or all of type default integer, default real, default complex, default logical or double precision real, the structure is treated as if its components are enumerated directly in the common block.

A data pointer object in a common block can only be storage associated with pointers of the same type, type parameters, and rank.

An object in a common block with **TARGET** attribute can be storage associated with another object. That object must have the **TARGET** attribute and have the same type and type parameters.

### IBM Extension

Pointers of type **BYTE** can be storage associated with pointers of type **INTEGER(1)** and **LOGICAL(1)**. Integer and logical pointers of the same length can be storage associated if you specify the **-qintlog** compiler option.

### End of IBM Extension

### Fortran 2003

A procedure pointer can be storage associated only with another procedure pointer; both interfaces must be either explicit or implicit. If both interfaces are explicit, their characteristics must be the same. If both interfaces are implicit, both must be subroutines or both must be functions with the same type and type

parameters.

---

End of Fortran 2003

---

If you specify *common\_block\_name*, all variables specified in the *object\_list* that follows are declared to be in that named common block. If you omit *common\_block\_name*, all variables that you specify in the *object\_list* that follows are in the blank common block.

Within a scoping unit, a common block name can appear more than once in the same or in different **COMMON** statements. Each successive appearance of the same common block name continues the common block specified by that name. Common block names are global entities.

The variables in a common block can have different data types. You can mix character and noncharacter data types within the same common block. Variable names in common blocks can appear in only one **COMMON** statement in a scoping unit, and you cannot duplicate them within the same **COMMON** statement.

See “Interoperability of common blocks” on page 744 for **BIND** information.

---

IBM Extension

---

By default, common blocks are shared across threads, and so the use of the **COMMON** statement is thread-unsafe if any storage unit in the common block needs to be updated by more than one thread, or is updated by one thread and referenced by another. To ensure your application uses **COMMON** in a thread-safe manner, you must either serialize access to the data using locks, or make certain that the common blocks are local to each thread. The **Pthreads** library module provides mutexes to allow you to serialize access to the data using locks. See Pthreads library module in the *XL Fortran Optimization and Programming Guide* for more information. The *lock\_name* attribute on the **CRITICAL** directive also provides the ability to serialize access to data. See **CRITICAL / END CRITICAL** in the *XL Fortran Optimization and Programming Guide* for more information. The **THREADLOCAL** and **THREADPRIVATE** directives ensure that common blocks are local to each thread. See **THREADLOCAL** and **THREADPRIVATE** in the *XL Fortran Optimization and Programming Guide* for more information.

---

End of IBM Extension

---

### Common association

Within an executable program, all nonzero-sized named common blocks with the same name have the same first storage unit. There can be one blank common block, and all scoping units that refer to nonzero-sized blank common refer to the same first storage unit.

All zero-sized common blocks with the same name are storage-associated with one another. All zero-sized blank common blocks are associated with one another and with the first storage unit of any nonzero-sized blank common blocks. Use association or host association can cause these associated objects to be accessible in the same scoping unit.

Because association is by storage unit, variables in a common block can have different names and types in different scoping units.

**Common block storage sequence:** Storage units for variables within a common block in a scoping unit are assigned in the order that their names appear within the **COMMON** statement.

You can extend a common block by using an **EQUIVALENCE** statement, but only by adding beyond the last entry, not before the first entry. For example, these statements specify X:

```
COMMON /X/ A,B      ! common block named X
REAL C(2)
EQUIVALENCE (B,C)
```

The contents of common block X are as follows:

Variable A:													
			A										
Variable B:							B						
Array C:							C(1)				C(2)		

Only **COMMON** and **EQUIVALENCE** statements that appear in a scoping unit contribute to the common block storage sequences formed in that unit, not including variables in common made accessible by use association or host association.

An **EQUIVALENCE** statement cannot cause the storage sequences of two different common blocks to become associated. While a common block can be declared in the scoping unit of a module, it must not be declared in another scoping unit that accesses entities from the module through use association.

Use of **COMMON** can lead to misaligned data. Any use of misaligned data can adversely affect the performance of the program.

**Size of a common block:** The size of a common block is equal to the number of bytes of storage needed to hold all the variables in the common block, including any extensions resulting from equivalence association.

**Differences between named and blank common blocks:**

- Within an executable program, there can be more than one named common block, but only one blank common block.
- In all scoping units of an executable program, named common blocks of the same name must have the same size, but blank common blocks can have different sizes. (If you specify blank common blocks with different sizes in different scoping units, the length of the longest block becomes the length of the blank common block in the executable program.)
- You can initially define objects in a named common block by using a **BLOCK DATA** program unit containing a **DATA** statement or a type declaration statement. You cannot initially define any elements of a blank common block

<b>IBM Extension</b>
If a named common block, or any part of it, is initialized in more than one scoping unit, the initial value is undefined. To avoid this problem, use block data program units or modules to initialize named common blocks; each named common block should be initialized in only one block data program unit or module.
<b>End of IBM Extension</b>

## Examples

```
INTEGER MONTH, DAY, YEAR
COMMON /DATE/ MONTH, DAY, YEAR
REAL      R4
REAL      R8
CHARACTER(1) C1
COMMON /NOALIGN/ R8, C1, R4      ! R4 will not be aligned on a
                                ! full-word boundary
```

## Related information

- Pthreads library module in the *XL Fortran Optimization and Programming Guide*
- “BIND” on page 285
- “Interoperability of common blocks” on page 744
- **THREADLOCAL**. See XL Fortran V11.1 for AIX Optimization and Programming Guide.
- “Block data program unit” on page 174
- “Explicit-shape arrays” on page 73
- “The scope of a name” on page 146, for details on global entities
- “Storage classes for variables” on page 26

---

## COMPLEX

### Purpose

A **COMPLEX** type declaration statement specifies the length and attributes of objects and functions of type complex. Initial values can be assigned to objects.

### Syntax

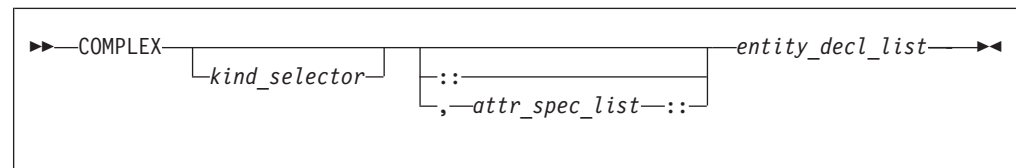

where:

<i>attr_spec</i>
ALLOCATABLE
ASYNCHRONOUS
AUTOMATIC
BIND
DIMENSION ( <i>array_spec</i> )
EXTERNAL
INTENT ( <i>intent_spec</i> )
INTRINSIC
OPTIONAL
PARAMETER
POINTER
PRIVATE
PROTECTED
PUBLIC
SAVE
STATIC
TARGET
VALUE
VOLATILE

*kind\_selector*

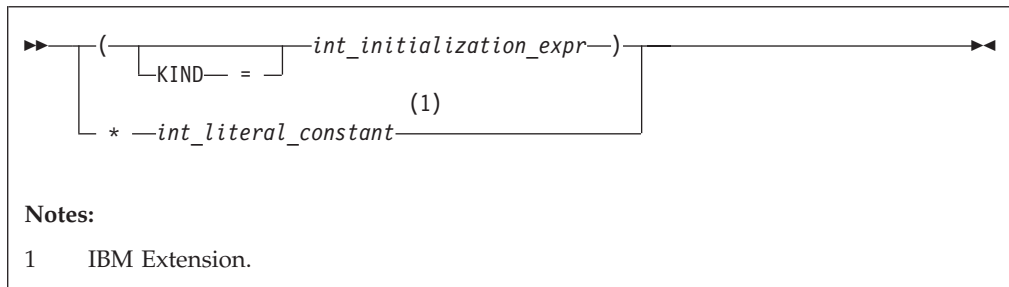

specifies the length of complex entities:

<b>IBM Extension</b>
<ul style="list-style-type: none"><li>• If <i>int_initialization_expr</i> is specified, the valid values are 4, 8 and 16. These values represent the precision and range of each part of the complex entity.</li><li>• If the <i>*int_literal_constant</i> form is specified, the valid values are 8, 16 and 32. These values represent the length of the whole complex entity, and correspond to the values allowed for the alternative form. <i>int_literal_constant</i> cannot specify a kind type parameter.</li></ul>
<b>End of IBM Extension</b>

*attr\_spec*

For detailed information on rules about a particular attribute, refer to the statement of the same name.

*intent\_spec*

is either **IN**, **OUT**, or **INOUT**

:: is the double colon separator. Use the double colon separator when you specify attributes, =*initialization\_expr*, F95 or => **NULL0** F95.



*array\_spec*  
is a list of dimension bounds.  
*entity\_decl*

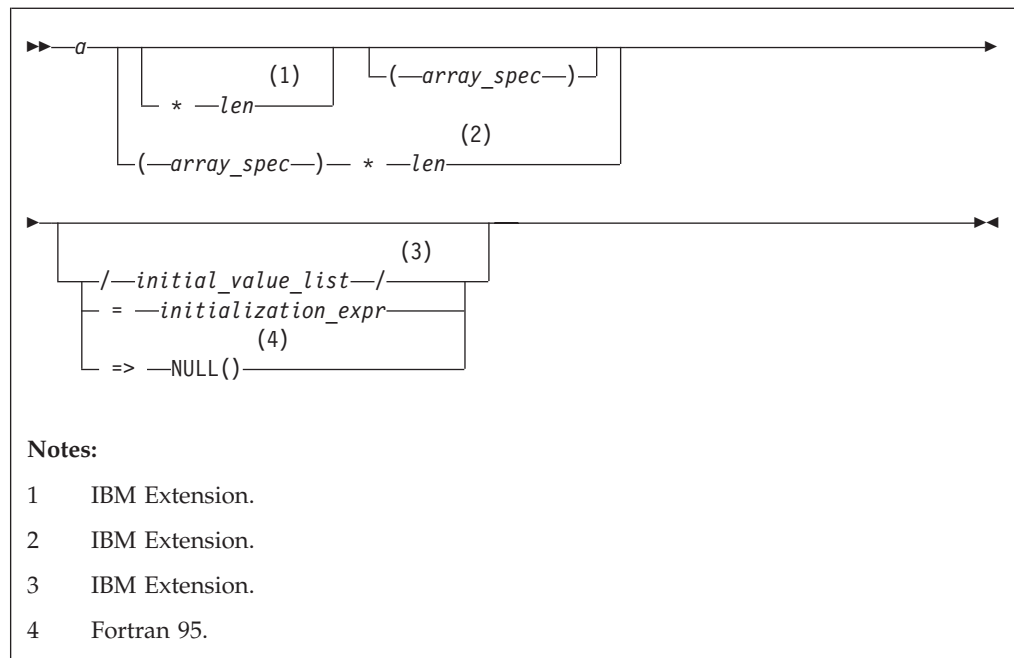

**Notes:**

- 1 IBM Extension.
- 2 IBM Extension.
- 3 IBM Extension.
- 4 Fortran 95.

*a* is an object name or function name. *array\_spec* cannot be specified for a function with an implicit interface.

**IBM Extension**

*len* overrides the length as specified in *kind\_selector*, and cannot specify a kind type parameter. The entity length must be an integer literal constant that represents one of the permissible length specifications.

**End of IBM Extension**

**IBM Extension**

*initial\_value* provides an initial value for the entity specified by the immediately preceding name

**End of IBM Extension**

*initialization\_expr* provides an initial value, by means of an initialization expression, for the entity specified by the immediately preceding name

**Fortran 95**

=> **NULL()**  
provides an initial value for the pointer object

End of Fortran 95

## Rules

Fortran 95

Within the context of a derived type definition:

- If => appears in a component initialization, the **POINTER** attribute must appear in the *attr\_spec\_list*.
- If = appears in a component initialization, the **POINTER** attribute cannot appear in the component *attr\_spec\_list*.
- The compiler will evaluate *initialization\_expr* within the scoping unit of the type definition.

If => appears for a variable, the object must have the **POINTER** attribute.

End of Fortran 95

If *initialization\_expr* appears for a variable, the object cannot have the **POINTER** attribute.

Entities in type declaration statements are constrained by the rules of any attributes specified for the entities, as detailed in the corresponding attribute statements.

The type declaration statement overrides the implicit type rules in effect. You can use a type declaration statement that confirms the type of an intrinsic function. The appearance of a generic or specific intrinsic function name in a type declaration statement does not cause the name to lose its intrinsic property.

An object cannot be initialized in a type declaration statement if it is a dummy argument, an allocatable object, a pointer, a function result, an object in blank common, an integer pointer, an external name, an intrinsic name, or an automatic object. Nor can an object be initialized if it has the **AUTOMATIC** attribute. The object may be initialized if:

- it appears in a named common block in a block data program unit.

IBM Extension

- if it appears in a named common block in a module.

End of IBM Extension

Fortran 95

In Fortran 95, a pointer can be initialized. Pointers can only be initialized by the use of => **NULL()**.

End of Fortran 95

The specification expression of an *array\_spec* can be a nonconstant expression if the specification expression appears in an interface body or in the specification part of

a subprogram. Any object being declared that uses this nonconstant expression and is not a dummy argument or a pointee is called an *automatic object*.

An attribute cannot be repeated in a given type declaration statement, nor can an entity be explicitly given the same attribute more than once in a scoping unit.

*initialization\_expr* must be specified if the statement contains the **PARAMETER** attribute. If *initialization\_expr* F95 or **NULL0** F95 is specified, and the entity you are declaring:

- is a variable, the variable is initially defined.

---

**Fortran 95**

- is a derived type component, the derived type has default initialization.

---

**End of Fortran 95**

*a* becomes defined with the value determined by *initialization\_expr*, in accordance with the rules for intrinsic assignment. If the entity is an array, its shape must be specified either in the type declaration statement or in a previous specification statement in the same scoping unit.

A variable or variable subobject cannot be initialized more than once. If *a* is a variable, the presence of *initialization\_expr* F95 or **NULL0** F95 implies that *a* is a saved object, except for an object in a named common block. The initialization of an object could affect the fundamental storage class of an object.

An *array\_spec* specified in the *entity\_decl* takes precedence over the *array\_spec* in the **DIMENSION** attribute.

An array function result that does not have the F2003 **ALLOCATABLE** or F2003 **POINTER** attribute must have an explicit-shape array specification.

If the entity declared is a function, it must not have an accessible explicit interface unless it is an intrinsic function.

---

**IBM Extension**

If *T* or *F*, defined previously as the name of a constant, appears in a type declaration statement, it is no longer an abbreviated logical constant but the name of the named constant.

---

**End of IBM Extension**

## Examples

```
COMPLEX, DIMENSION (2,3) :: ABC(3) ! ABC has 3 (not 6) array elements
```

## Related information

- “Complex” on page 39
- “Initialization expressions” on page 95
- “Determining Type” on page 17, for details on the implicit typing rules
- “Array declarators” on page 73
- “Automatic objects” on page 18

- “Storage classes for variables” on page 26
- “DATA” on page 314, for details on initial values

---

## CONTAINS

### Purpose

The **CONTAINS** statement separates the body of a main program, external subprogram, or module subprogram from any internal subprograms that it may contain. Similarly, it separates the specification part of a module from any module subprograms.

Fortran 2003

The **CONTAINS** statement also introduces the procedure part of a derived-type definition.

End of Fortran 2003

### Syntax

```
▶▶ CONTAINS ◀◀
```

### Rules

For a **CONTAINS** statement associated with subprograms, the following rules apply:

- When a **CONTAINS** statement exists, at least one subprogram must follow it.
- The **CONTAINS** statement cannot appear in a block data program unit or in an internal subprogram.
- Any label of a **CONTAINS** statement is considered part of the main program, subprogram, or module that contains the **CONTAINS** statement.

Fortran 2003

For a **CONTAINS** statement associated with a derived-type definition, at least one procedure must follow the statement.

End of Fortran 2003

### Examples

#### An example of a **CONTAINS** statement

```
MODULE A
  ...
  CONTAINS                ! Module subprogram must follow
  SUBROUTINE B(X)
  ...
  CONTAINS                ! Internal subprogram must follow
  FUNCTION C(Y)
```

```

...
END FUNCTION
END SUBROUTINE
END MODULE

```

### An example of a CONTAINS statement in a derived type definition

```

TYPE CUST
  INTEGER :: CUST_NUMBER
  CONTAINS
  PROCEDURE, PASS :: GET_CUST => GET_CUST_NUMBER
END TYPE CUST

```

## Related information

- “Program units, procedures, and subprograms” on page 154

## CONTINUE

### Purpose

The **CONTINUE** statement is an executable control statement that takes no action; it has no effect. This statement is often used as the terminal statement of a loop.

### Syntax

```

▶▶—CONTINUE—◀◀

```

### Examples

```

DO 100 I = 1,N
  X = X + N
100 CONTINUE

```

## Related information

- Chapter 7, “Execution Control,” on page 129

## CYCLE

### Purpose

The **CYCLE** statement terminates the current execution cycle of a **DO** or **DO WHILE** construct.

### Syntax

```

▶▶—CYCLE—◀◀
      └─DO_construct_name─┘

```

*DO\_construct\_name*  
is the name of a **DO** or **DO WHILE** construct

## Rules

The **CYCLE** statement is placed within a **DO** or **DO WHILE** construct and belongs to the particular **DO** or **DO WHILE** construct specified by *DO\_construct\_name* or, if not specified, to the **DO** or **DO WHILE** construct that immediately surrounds it. The statement terminates only the current cycle of the construct that it belongs to.

When the **CYCLE** statement is executed, the current execution cycle of the **DO** or **DO WHILE** construct is terminated. Any executable statements after the **CYCLE** statement, including any terminating labeled action statement, will not be executed. For **DO** constructs, program execution continues with incrementation processing, if any. For **DO WHILE** constructs, program execution continues with loop control processing.

A **CYCLE** statement can have a statement label. However, it cannot be used as a labeled action statement that terminates a **DO** construct.

## Examples

```
LOOP1: DO I = 1, 20
      N = N + 1
      IF (N > NMAX) CYCLE LOOP1           ! cycle to LOOP1

      LOOP2: DO WHILE (K==1)
            IF (K > KMAX) CYCLE           ! cycle to LOOP2
            K = K + 1
      END DO LOOP2

      LOOP3: DO J = 1, 10
            N = N + 1
            IF (N > NMAX) CYCLE LOOP1     ! cycle to LOOP1
            CYCLE LOOP3                  ! cycle to LOOP3
      END DO LOOP3

END DO LOOP1
END
```

## Related information

- “DO” on page 323
- “DO WHILE” on page 325

---

## DATA

### Purpose

The **DATA** statement provides initial values for variables.

### Syntax

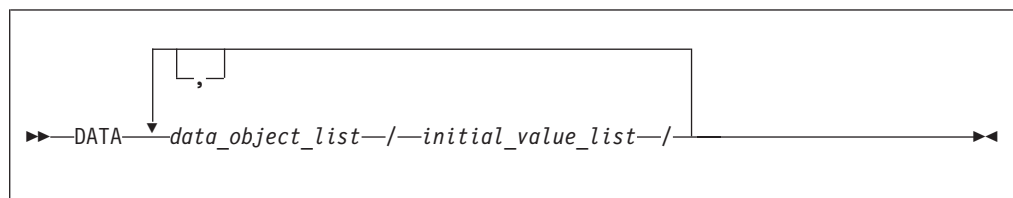

*data\_object*

is a variable or an implied-**DO** list. Any subscript or substring expression must be an initialization expression.

*implied-DO list*

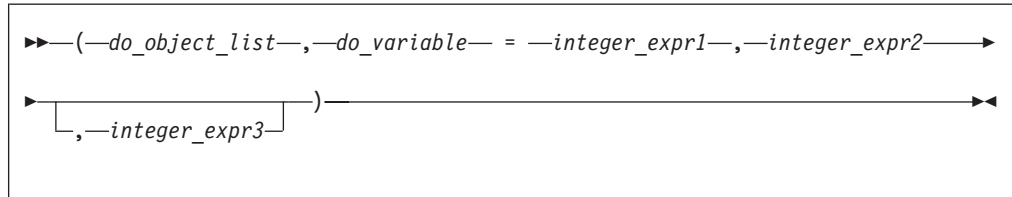

*do\_object*

is an array element, scalar structure component, substring, or implied-**DO** list

*do\_variable*

is a named scalar integer variable called the implied-**DO** variable. This variable is a statement entity.

*integer\_expr1*, *integer\_expr2*, and *integer\_expr3*

are each scalar integer expressions. The primaries of an expression can only contain constants or implied-**DO** variables of other implied-**DO** lists that have this implied-**DO** list within their ranges. Each operation must be intrinsic.

*initial\_value*

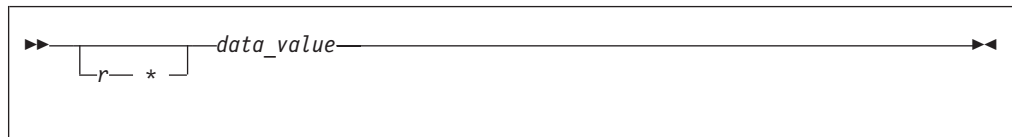

*r*

is a nonnegative scalar integer constant. If *r* is a named constant, it must have been declared previously in the scoping unit or made accessible by use or host association.

**Fortran 95**

*r* may also be a nonnegative scalar integer subobject of a constant. Similar to the above paragraph, if it is a subobject of a named constant, it must have been declared previously in the scoping unit or made accessible by use or host association.

**End of Fortran 95**

If *r* is a subobject of a constant, any subscript in it is an initialization expression. If *r* is omitted, the default value is 1. The form *r\*data\_value* is equivalent to *r* successive appearances of the data value.

*data\_value*

is a scalar constant, signed integer literal constant, signed real literal constant, structure constructor, F95 scalar subobject of a constant, or `NULL()`. F95

## Rules

Specifying a nonpointer array object as a *data\_object* is the same as specifying a list of all the elements in the array object in the order they are stored.

**Fortran 95**

An array with pointer attribute has only one corresponding initial value which is `NULL()`.

**End of Fortran 95**

Each *data\_object\_list* must specify the same number of items as its corresponding *initial\_value\_list*. There is a one-to-one correspondence between the items in these two lists. This correspondence establishes the initial value of each *data\_object*.

**Fortran 95**

For pointer initialization, if the *data\_value* is `NULL()` then the corresponding *data\_object* must have pointer attribute. If the *data\_object* has pointer attribute then the corresponding *data\_value* must be `NULL()`.

**End of Fortran 95**

The definition of each *data\_object* by its corresponding *initial\_value* must follow the rules for intrinsic assignment, except as noted under "Using typeless constants" on page 31.

If *initial\_value* is a structure constructor, each component must be an initialization expression. If *data\_object* is a variable, any substring, subscript, or stride expressions must be initialization expressions.

If *data\_value* is a named constant or a subobject of a named constant, the named constant must have been previously declared in the scoping unit, or made accessible by host or use association. If *data\_value* is a structure constructor, the derived type must have been previously declared in the scoping unit, or made accessible by host or use association.

Zero-sized arrays, implied-**DO** lists with iteration counts of zero, and values with a repeat factor of zero contribute no variables to the expanded *initial\_value\_list*, although a zero-length scalar character variable contributes one variable to the list.

You can use an implied-**DO** list in a **DATA** statement to initialize array elements, scalar structure components and substrings. The implied-**DO** list is expanded into a sequence of scalar structure components, array elements, or substrings, under the control of the implied-**DO** variable. Array elements and scalar structure components must not have constant parents. Each scalar structure component must contain at least one component reference that specifies a subscript list.

The range of an implied-**DO** list is the *do\_object\_list*. The iteration count and the values of the implied-**DO** variable are established from *integer\_expr1*, *integer\_expr2*,



and *integer\_expr3*, the same as for a **DO** statement. When the implied-**DO** list is executed, it specifies the items in the *do\_object\_list* once for each iteration of the implied-**DO** list, with the appropriate substitution of values for any occurrence of the implied-**DO** variables. If the implied-**DO** variable has an iteration count of 0, no variables are added to the expanded sequence.

Each subscript expression in a *do\_object* can only contain constants or implied-**DO** variables of implied-**DO** lists that have the subscript expression within their ranges. Each operation must be intrinsic.

#### IBM Extension







To initialize list items of type logical with logical constants, you can also use the abbreviated forms (T for `.TRUE.` and F for `.FALSE.`). If T or F is a constant name that was defined previously with the **PARAMETER** attribute, XL Fortran recognizes it as the named constant and assigns its value to the corresponding list item in the **DATA** statement.

#### End of IBM Extension

In a block data program unit, you can use a **DATA** statement or type declaration statement to provide an initial value for a variable in a named common block.

In an internal or module subprogram, if the *data\_object* is the same name as an entity in the host, and the *data\_object* is not declared in any other specification statement in the internal subprogram, the *data\_object* must not be referenced or defined before the **DATA** statement.

A **DATA** statement cannot provide an initial value for:

- An automatic object.
- A dummy argument.
-  A pointer. 
- A variable in a blank common block.
- The result variable of a function.
-  A data object whose storage class is automatic. 
-  A variable that has the **ALLOCATABLE** attribute. 

You must not initialize a variable more than once in an executable program. If you associate two or more variables, you can only initialize one of the data objects.

## Examples

### Example 1:

```

      INTEGER Z(100),EVEN_ODD(0:9)
      LOGICAL FIRST_TIME
      CHARACTER*10 CHARARR(1)
      DATA  FIRST_TIME / .TRUE. /
      DATA  Z / 100* 0 /
! Implied-DO list
      DATA (EVEN_ODD(J),J=0,8,2) / 5 * 0 / &
      &      ,(EVEN_ODD(J),J=1,9,2) / 5 * 1 /
! Nested example
      DIMENSION TDARR(3,4) ! Initializes a two-dimensional array
      DATA ((TDARR(I,J),J=1,4),I=1,3) /12 * 0/
! Character substring example

```

```

DATA (CHARARR(J)(1:3),J=1,1) /'aaa'/
DATA (CHARARR(J)(4:7),J=1,1) /'bbbb'/
DATA (CHARARR(J)(8:10),J=1,1) /'ccc'/
! CHARARR(1) contains 'aaabbbccc'

```

### Example 2:

```

TYPE DT
  INTEGER :: COUNT(2)
END TYPE DT

TYPE(DT), PARAMETER, DIMENSION(3) :: SPARM = DT ( (/3,5/) )

INTEGER :: A(5)

DATA A /SPARM(2)%COUNT(2) * 10/

```

## Related information

- “Executing a DO statement” on page 132
- “Statement and construct entities” on page 148

---

## DEALLOCATE

### Purpose

The **DEALLOCATE** statement dynamically deallocates allocatable objects and pointer targets. A specified pointer becomes disassociated, while any other pointers associated with the target become undefined.

### Syntax

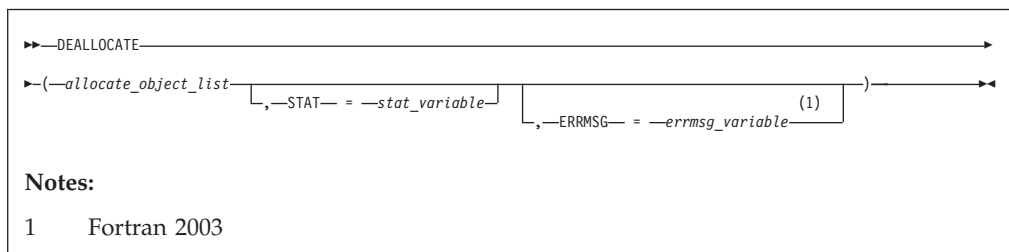

*allocate\_object*  
is a data pointer or an allocatable object

*stat\_variable*  
is a scalar integer variable

▶ **F2003** *errmsg\_variable* is a scalar character variable **F2003** ◀

### Rules

An allocatable object that appears in a **DEALLOCATE** statement must be currently allocated.

---

#### Fortran 2003

---

When the result of a referenced function is allocatable, or has a structure with allocatable subobjects, that result and any allocated allocatable subobjects are

deallocated after execution of the innermost executable construct containing the function reference.

End of Fortran 2003

An allocatable object with the **TARGET** attribute cannot be deallocated through an associated pointer. Deallocation of such an object causes the association status of any associated pointer to become undefined. An allocatable object that has an undefined allocation status cannot be subsequently referenced, defined, allocated, or deallocated. Successful execution of a **DEALLOCATE** statement causes the allocation status of an allocatable object to become not allocated.

Fortran 2003

An object being deallocated will be finalized first. When a variable of derived type is deallocated, any allocated subobject with the **ALLOCATABLE** attribute is also deallocated. If an allocatable component is a subobject of a finalizable object, that object is finalized before the component is automatically deallocated.

End of Fortran 2003

When an intrinsic assignment statement is executed, any allocated subobject of the variable is deallocated before the assignment takes place.

A pointer that appears in a **DEALLOCATE** statement must be associated with a whole target that was created with an **ALLOCATE** statement. Deallocation of a pointer target causes the association status of any other pointer associated with all or part of the target to become undefined.

**Tips**

Use the **DEALLOCATE** statement instead of the **NULLIFY** statement if no other pointer is associated with the allocated memory.

Deallocate memory that a pointer function has allocated.

If the **STAT=** specifier is not present and an error condition occurs during execution of the statement, the program terminates. If the **STAT=** specifier is present, *stat\_variable* is assigned one of the following values:

IBM Extension

Stat value	Error condition
0	No error
1	Error in system routine attempting to do deallocation
2	An invalid data object has been specified for deallocation
3	Both error conditions 1 and 2 have occurred

End of IBM Extension

Fortran 2003

If an error condition occurs during execution of the **DEALLOCATE** statement, an

explanatory message is assigned to *errmsg\_variable*. If no such condition occurs, the value of *errmsg\_variable* is not changed.

End of Fortran 2003

An *allocate\_object* must not depend on the value, bounds, allocation status, or association status of another *allocate\_object* in the same **DEALLOCATE** statement; nor does it depend on the value of the *stat\_variable* **F2003** or *errmsg\_variable* **F2003** in the same **DEALLOCATE** statement.

*stat\_variable* and *errmsg\_variable* must not be deallocated within the same **DEALLOCATE** statement. The variable must not depend on the value, bounds, allocation status, or association status of any *allocate\_object* in the same **DEALLOCATE** statement.

## Examples

```

INTEGER, ALLOCATABLE :: A(:, :)
INTEGER X, Y

      ⋮
ALLOCATE (A(X, Y))

      ⋮
DEALLOCATE (A, STAT=I)
END

```

## Related information

- “ALLOCATE” on page 275
- “ALLOCATABLE” on page 274
- “Allocation status” on page 26
- “Pointer association” on page 152
- “Deferred-shape arrays” on page 76
- “Allocatable objects as dummy arguments” on page 190
- “Allocatable components” on page 55

---

## Derived Type

### Purpose

The **Derived Type** statement is the first statement of a derived-type definition.

### Syntax

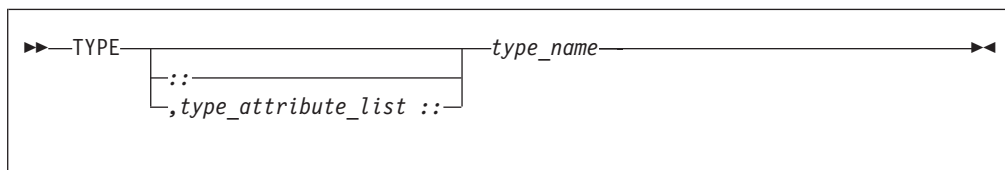

*type\_attribute*  
is **PRIVATE**, **PUBLIC**, **F2003** **BIND(C)**, *extends\_spec*, or **ABSTRACT**  
**F2003**.

*type\_name*  
is the name of the derived type

Fortran 2003

*extends\_spec*  
is

▶▶ EXTENDS (—*parent\_type\_name*—) ▶▶

End of Fortran 2003

## Rules

Fortran 2003

The same type attribute can not occur more than once on the same derived type statement.

End of Fortran 2003

You can only specify the **PRIVATE** or **PUBLIC** attribute if the derived type definition is within the specification part of a module. A derived type definition can be **PRIVATE** or **PUBLIC**, not both.

The *type\_name* must not be the same as the name of any intrinsic type, except **BYTE** and **DOUBLECOMPLEX**. The *type\_name* must also not be the name of any other accessible derived type.

Fortran 2003

**BIND(C)** explicitly defines the Fortran derived type as interoperable with a C type. The components must be of interoperable types. (See “Interoperability of types” on page 743 for additional information.) A derived type with the **BIND** attribute cannot be a **SEQUENCE** type. A component of a derived type with the **BIND** attribute must have interoperable type and type parameters, and cannot have the **POINTER** or **ALLOCATABLE** attribute.

The *parent\_type\_name* must be an accessible extensible type.

You can only specify the **ABSTRACT** attribute for an extensible type.

If **EXTENDS** is specified, **SEQUENCE** cannot appear for that type.

If **EXTENDS** is specified, the type must not have the **BIND(C)** attribute.

End of Fortran 2003

If a label is specified on the **Derived Type** statement, the label belongs to the scoping unit of the derived-type definition.

If the corresponding **END TYPE** statement specifies a name, it must be the same as *type\_name*.

## Examples

```
MODULE ABC
  TYPE, PRIVATE :: SYSTEM      ! Derived type SYSTEM can only be accessed
  SEQUENCE                   ! within module ABC
    REAL :: PRIMARY
    REAL :: SECONDARY
    CHARACTER(20), DIMENSION(5) :: STAFF
  END TYPE
END MODULE
```

## Related information

- Chapter 4, “Derived Types,” on page 47
- “Interoperability of types” on page 743
- “END TYPE” on page 341
- “SEQUENCE” on page 448
- “Extensible derived types” on page 51
- “Abstract types and deferred bindings” on page 52

---

## DIMENSION

### Purpose

The **DIMENSION** attribute specifies the name and dimensions of an array.

### Syntax

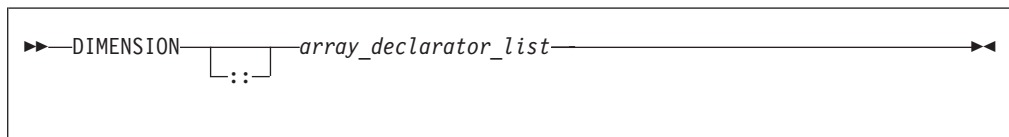

### Rules

The Fortran standard allows arrays with up to seven dimensions.

#### IBM Extension

With XL Fortran, you can specify up to 20 dimensions.

#### End of IBM Extension

Only one dimension specification for an array name can appear in a scoping unit.

### Attributes compatible with the DIMENSION attribute

- ALLOCATABLE
- ASYNCHRONOUS
- AUTOMATIC
- BIND
- INTENT
- OPTIONAL
- PARAMETER
- POINTER
- PRIVATE
- PROTECTED
- PUBLIC
- SAVE
- STATIC
- TARGET
- VOLATILE

## Examples

```
CALL SUB(5,6)
CONTAINS
SUBROUTINE SUB(I,M)
  DIMENSION LIST1(I,M)                ! automatic array
  INTEGER, ALLOCATABLE, DIMENSION(:, :) :: A ! deferred-shape array
  :
END SUBROUTINE
END
```

## Related information

- Chapter 5, “Array concepts,” on page 71
- “VIRTUAL” on page 473

## DO

### Purpose

The **DO** statement controls the execution of the statements that follow it, up to and including a specified terminal statement. Together, these statements form a **DO** construct.

### Syntax

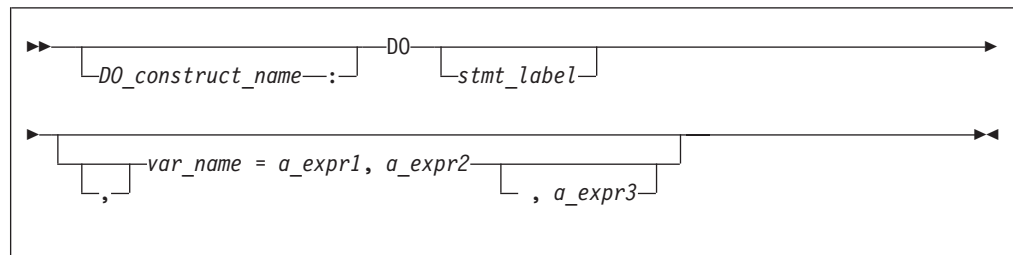

*DO\_construct\_name*

is a name that identifies the **DO** construct.

*stmt\_label*

is the statement label of an executable statement appearing after the **DO** statement in the same scoping unit. This statement denotes the end of the **DO** construct.

*var\_name*

is a scalar variable name of type integer or real, called the **DO** variable

*a\_expr1*, *a\_expr2*, and *a\_expr3*

are each scalar expressions of type integer or real

## Rules

If you specify a *DO\_construct\_name* on the **DO** statement, you must terminate the construct with an **END DO** and the same *DO\_construct\_name*. Conversely, if you do not specify a *DO\_construct\_name* on the **DO** statement, and you terminate the **DO** construct with an **END DO** statement, you must not have a *DO\_construct\_name* on the **END DO** statement.

If you specify a statement label in the **DO** statement, you must terminate the **DO** construct with a statement that is labeled with that statement label. You can terminate a labeled **DO** statement with an **END DO** statement that is labeled with that statement label, but you cannot terminate it with an unlabeled **END DO** statement. If you do not specify a label in the **DO** statement, you must terminate the **DO** construct with an **END DO** statement.

If the control clause (the clause beginning with *var\_name*) is absent, the statement is an infinite **DO**. The loop will iterate indefinitely until interrupted (for example, by the **EXIT** statement).

## Examples

```
INTEGER :: SUM=0
OUTER: DO
  INNER: DO M=1,10
    READ (5,*) J
    IF (J.LE.I) THEN
      PRINT *, 'VALUE MUST BE GREATER THAN ', I
      CYCLE INNER
    END IF
    SUM=SUM+J
    IF (SUM.GT.500) EXIT OUTER
    IF (SUM.GT.100) EXIT INNER
  END DO INNER
  SUM=SUM+I
  I=I+10
END DO OUTER
PRINT *, 'SUM =',SUM
END
```

## Related information

- “DO construct” on page 131
- “END (Construct)” on page 336, for details on the **END DO** statement
- “EXIT” on page 351
- “CYCLE” on page 313
- “INDEPENDENT ” on page 500
- “ASSERT” on page 492
- “CNCALL” on page 496
- “PERMUTATION” on page 508
- **PARALLEL DO/END PARALLEL DO** in the *XL Fortran Optimization and Programming Guide*



---

## DO WHILE

### Purpose

The **DO WHILE** statement is the first statement in the **DO WHILE** construct, which indicates that you want the following statement block, up to and including a specified terminal statement, to be repeatedly executed for as long as the logical expression specified in the statement continues to be true.

### Syntax

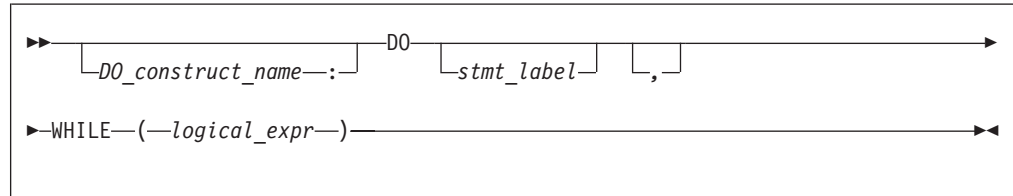

*DO\_construct\_name*

is a name that identifies the **DO WHILE** construct

*stmt\_label*

is the statement label of an executable statement appearing after the **DO WHILE** statement in the same scoping unit. It denotes the end of the **DO WHILE** construct.

*logical\_expr*

is a scalar logical expression

### Rules

If you specify a *DO\_construct\_name* on the **DO WHILE** statement, you must terminate the construct with an **END DO** and the same *DO\_construct\_name*. Conversely, if you do not specify a *DO\_construct\_name* on the **DO WHILE** statement, and you terminate the **DO WHILE** construct with an **END DO** statement, you must not have a *DO\_construct\_name* on the **END DO** statement.

If you specify a statement label in the **DO WHILE** statement, you must terminate the **DO WHILE** construct with a statement that is labeled with that statement label. You can terminate a labeled **DO WHILE** statement with an **END DO** statement that is labeled with that statement label, but you cannot terminate it with an unlabeled **END DO** statement. If you do not specify a label in the **DO WHILE** statement, you must terminate the **DO WHILE** construct with an **END DO** statement.

### Examples

```
MYDO: DO 10 WHILE (I .LE. 5) ! MYDO is the construct name
      SUM = SUM + INC
      I = I + 1
10   END DO MYDO
      END

SUBROUTINE EXAMPLE2
  REAL X(10)
  LOGICAL FLAG1
  DATA FLAG1 /.TRUE./
  DO 20 WHILE (I .LE. 10)
```

```

          X(I) = A
          I = I + 1
20      IF (.NOT. FLAG1) STOP
      END SUBROUTINE EXAMPLE2

```

## Related information

- “DO WHILE construct” on page 135
- “END (Construct)” on page 336, for details on the **END DO** statement
- “EXIT” on page 351
- “CYCLE” on page 313

---

## DOUBLE COMPLEX

### IBM Extension

### Purpose

A **DOUBLE COMPLEX** type declaration statement specifies the attributes of objects and functions of type double complex. Initial values can be assigned to objects.

### Syntax

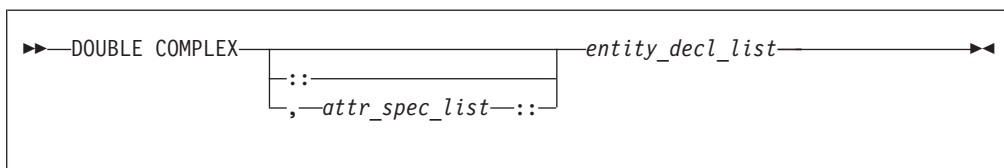

where:

<i>attr_spec</i>
ALLOCATABLE
ASYNCHRONOUS
AUTOMATIC
BIND
DIMENSION ( <i>array_spec</i> )
EXTERNAL
INTENT ( <i>intent_spec</i> )
INTRINSIC
OPTIONAL
PARAMETER
POINTER
PRIVATE
PROTECTED
PUBLIC
SAVE
STATIC
TARGET
VALUE
VOLATILE

*attr\_spec* For detailed information on rules about a particular attribute, refer to the statement of the same name.

*intent\_spec* is either **IN**, **OUT**, or **INOUT**

:: is the double colon separator. Use the double colon separator when you specify attributes, `=initialization_expr`, `F95` or `=> NULL()`

*array\_spec* is a list of dimension bounds

*entity\_decl*

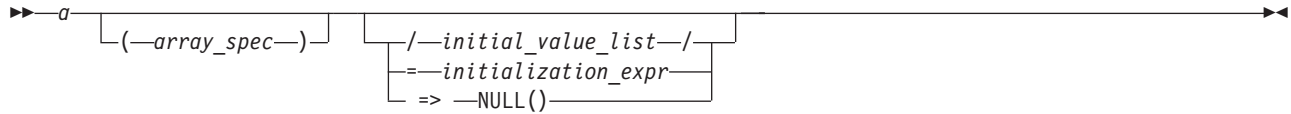

*a* is an object name or function name. *array\_spec* cannot be specified for a function with an implicit interface.

*initial\_value* provides an initial value for the entity specified by the immediately preceding name

*initialization\_expr* provides an initial value, by means of an initialization expression, for the entity specified by the immediately preceding name

`=> NULL()` provides the initial value for the pointer object

## Rules

Within the context of a derived type definition:

- If `=>` appears in a component initialization, the **POINTER** attribute must appear in the *attr\_spec\_list*.
- If `=` appears in a component initialization, the **POINTER** attribute cannot appear in the component *attr\_spec\_list*.
- The compiler will evaluate *initialization\_expr* within the scoping unit of the type definition.

If `=>` appears for a variable, the object must have the **POINTER** attribute.

If *initialization\_expr* appears for a variable, the object cannot have the **POINTER** attribute.

Entities in type declaration statements are constrained by the rules of any attributes specified for the entities, as detailed in the corresponding attribute statements.

The type declaration statement overrides the implicit type rules in effect. You can use a type declaration statement that confirms the type of an intrinsic function. The appearance of a generic or specific intrinsic function name in a type declaration statement does not cause the name to lose its intrinsic property.

An object cannot be initialized in a type declaration statement if it is a dummy argument, an allocatable object, a function result, an object in blank common, an integer pointer, an external name, an intrinsic name, or an automatic object. Nor can an object be initialized if it has the **AUTOMATIC** attribute. The object may be initialized if it appears in a named common block in a block data program unit or if it appears in a named common block in a module.

In Fortran 95, a pointer can be initialized. Pointers can only be initialized by the use of `=> NULL()`.

The specification expression of an *array\_spec* can be a nonconstant expression if the specification expression appears in an interface body or in the specification part of a subprogram. Any object being declared that uses this nonconstant expression and is not a dummy argument or a pointee is called an *automatic object*.

An attribute cannot be repeated in a given type declaration statement, nor can an entity be explicitly given the same attribute more than once in a scoping unit.

*initialization\_expr* must be specified if the statement contains the **PARAMETER** attribute. If the entity you are declaring is a variable, and *initialization\_expr* or **NULL()** is specified, the variable is initially defined. If the entity you are declaring is a derived type component, and *initialization\_expr* or **NULL()** is specified, the derived type has default initialization. *a* becomes defined with the value determined by *initialization\_expr*, in accordance with the rules for intrinsic assignment. If the entity is an array, its shape must be specified either in the type declaration statement or in a previous specification statement in the same scoping unit. A variable or variable subobject cannot be initialized more than once. If *a* is a variable, the presence of *initialization\_expr* or `=> NULL()` implies that *a* is a saved object, except for an object in a named common block. The initialization of an object could affect the fundamental storage class of an object.

An *array\_spec* specified in the *entity\_decl* takes precedence over the *array\_spec* in the **DIMENSION** attribute.

An array function result that does not have the **F2003** **ALLOCATABLE** or **F2003** **POINTER** attribute must have an explicit-shape array specification.

If the entity declared is a function, it must not have an accessible explicit interface unless it is an intrinsic function.

If **T** or **F**, defined previously as the name of a constant, appears in a type declaration statement, it is no longer an abbreviated logical constant but the name of the named constant.

## Examples

```
SUBROUTINE SUB
  DOUBLE COMPLEX, STATIC, DIMENSION(1) :: B
END SUBROUTINE
```

## Related information

- “COMPLEX” on page 307
- “Initialization expressions” on page 95
- “Determining Type” on page 17, for details on the implicit typing rules
- “Array declarators” on page 73
- “Automatic objects” on page 18
- “Storage classes for variables” on page 26
- “DATA” on page 314, for details on initial values

## DOUBLE PRECISION

### Purpose

A **DOUBLE PRECISION** type declaration statement specifies the attributes of objects and functions of type double precision. Initial values can be assigned to objects.

### Syntax

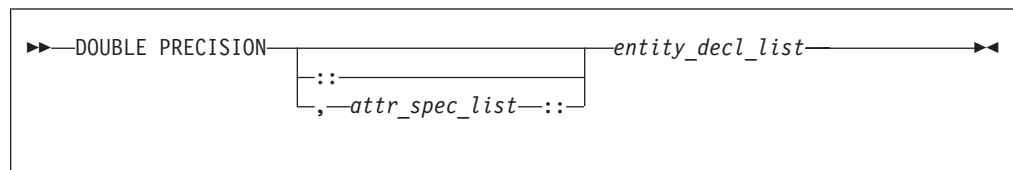

where:

<i>attr_spec</i>
ALLOCATABLE
ASYNCHRONOUS
AUTOMATIC
BIND
DIMENSION ( <i>array_spec</i> )
EXTERNAL
INTENT ( <i>intent_spec</i> )
INTRINSIC
OPTIONAL
PARAMETER
POINTER
PRIVATE
PROTECTED
PUBLIC
SAVE
STATIC
TARGET
VALUE
VOLATILE

*attr\_spec*

For detailed information on rules about a particular attribute, refer to the statement of the same name.

*intent\_spec*

is either **IN**, **OUT**, or **INOUT**

**::** is the double colon separator. Use the double colon separator when you specify attributes, =*initialization\_expr*, **F95** or => **NULL()** **F95**.

*array\_spec*

is a list of dimension bounds

*entity\_decl*

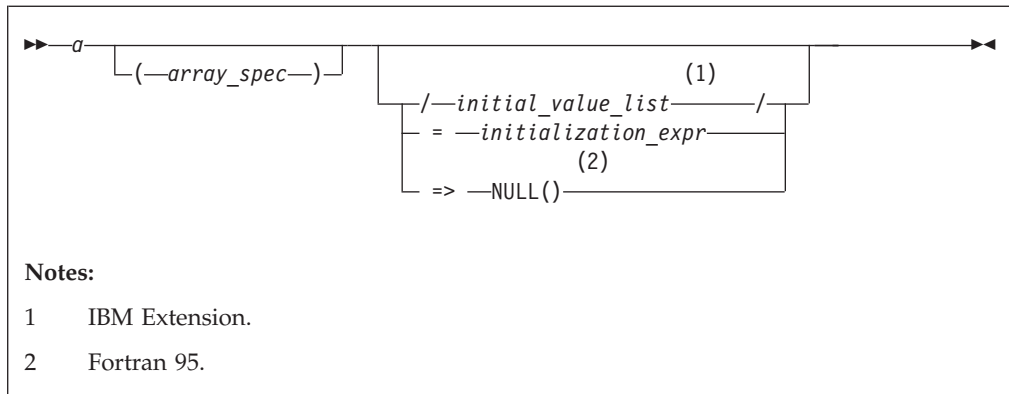

*a* is an object name or function name. *array\_spec* cannot be specified for a function with an implicit interface.

**IBM Extension**

*initial\_value*

provides an initial value for the entity specified by the immediately preceding name

**End of IBM Extension**

*initialization\_expr*

provides an initial value, by means of an initialization expression, for the entity specified by the immediately preceding name

**Fortran 95**

**=> NULL()**

provides the initial value for the pointer object

**End of Fortran 95**

## Rules

**Fortran 95**

Within the context of a derived type definition:

- If => appears in a component initialization, the **POINTER** attribute must appear in the *attr\_spec\_list*.
- If = appears in a component initialization, the **POINTER** attribute cannot appear in the component *attr\_spec\_list*.
- The compiler will evaluate *initialization\_expr* within the scoping unit of the type definition.

If => appears for a variable, the object must have the **POINTER** attribute.

**End of Fortran 95**

If *initialization\_expr* appears for a variable, the object cannot have the **POINTER** attribute.

Entities in type declaration statements are constrained by the rules of any attributes specified for the entities, as detailed in the corresponding attribute statements.

The type declaration statement overrides the implicit type rules in effect. You can use a type declaration statement that confirms the type of an intrinsic function. The appearance of a generic or specific intrinsic function name in a type declaration statement does not cause the name to lose its intrinsic property.

An object cannot be initialized in a type declaration statement if it is a dummy argument, an allocatable object, a function result, an object in blank common, an integer pointer, an external name, an intrinsic name, or an automatic object. Nor can an object be initialized if it has the **AUTOMATIC** attribute. The object may be initialized if it appears in a named common block in a block data program unit

▶ **IBM** or if it appears in a named common block in a module. **IBM** ◀

---

**Fortran 95**

In Fortran 95, a pointer can be initialized. Pointers can only be initialized by the use of `=> NULL()`.

---

**End of Fortran 95**

The specification expression of an *array\_spec* can be a nonconstant expression if the specification expression appears in an interface body or in the specification part of a subprogram. Any object being declared that uses this nonconstant expression and is not a dummy argument or a pointee is called an *automatic object*.

An attribute cannot be repeated in a given type declaration statement, nor can an entity be explicitly given the same attribute more than once in a scoping unit.

---

**Fortran 95**

*initialization\_expr* must be specified if the statement contains the **PARAMETER** attribute. If the entity you are declaring is a variable, and *initialization\_expr* or **NULL()** is specified, the variable is initially defined. If the entity you are declaring is a derived type component, and *initialization\_expr* or **NULL()** is specified, the derived type has default initialization. *a* becomes defined with the value determined by *initialization\_expr*, in accordance with the rules for intrinsic assignment. If the entity is an array, its shape must be specified either in the type declaration statement or in a previous specification statement in the same scoping unit. A variable or variable subobject cannot be initialized more than once. If *a* is a variable, the presence of *initialization\_expr* or `=> NULL()` implies that *a* is a saved object, except for an object in a named common block. The initialization of an object could affect the fundamental storage class of an object.

---

**End of Fortran 95**

An *array\_spec* specified in the *entity\_decl* takes precedence over the *array\_spec* in the **DIMENSION** attribute.

An array function result that does not have the **POINTER** attribute must have an explicit-shape array specification.

If the entity declared is a function, it must not have an accessible explicit interface unless it is an intrinsic function.

### IBM Extension

If T or F, defined previously as the name of a constant, appears in a type declaration statement, it is no longer an abbreviated logical constant but the name of the named constant.

End of IBM Extension

## Examples

```
DOUBLE PRECISION, POINTER :: PTR  
DOUBLE PRECISION, TARGET :: TAR
```

## Related information

- “REAL” on page 435
- “Initialization expressions” on page 95
- “Determining Type” on page 17, for details on the implicit typing rules
- “Array declarators” on page 73
- “Automatic objects” on page 18
- “Storage classes for variables” on page 26
- “DATA” on page 314, for details on initial values

---

## ELSE

### Purpose

The **ELSE** statement is the first statement of the optional **ELSE** block within an **IF** construct.

### Syntax

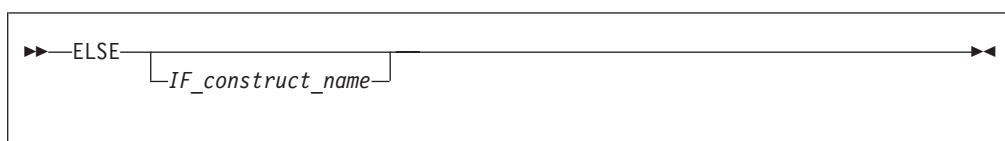

*IF\_construct\_name*

is a name that identifies the **IF** construct

### Syntax

Control branches to the **ELSE** block if every previous logical expression in the **IF** construct evaluates as false. The statement block of the **ELSE** block is executed and the **IF** construct is complete.

If you specify an *IF\_construct\_name*, it must be the same name that you specified in the block **IF** statement.

### Examples

```
IF (A.GT.0) THEN  
  B = B-A  
ELSE ! the next statement is executed if a<=0  
  B = B+A  
END IF
```



## Related information

- “IF construct” on page 136
- “END (Construct)” on page 336, for details on the **END IF** statement
- “ELSE IF”

---

## ELSE IF

### Purpose

The **ELSE IF** statement is the first statement of an optional **ELSE IF** block within an **IF** construct.

### Syntax

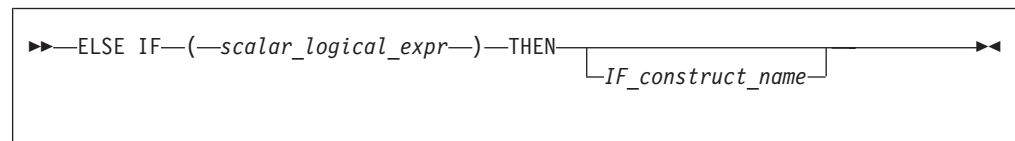

*IF\_construct\_name*

is a name that identifies the **IF** construct

### Rules

*scalar\_logical\_expr* is evaluated if no previous logical expressions in the **IF** construct are evaluated as true. If *scalar\_logical\_expr* is true, the statement block that follows is executed and the **IF** construct is complete.

If you specify an *IF\_construct\_name*, it must be the same name that you specified in the block **IF** statement.

### Examples

```
IF (I.EQ.1) THEN
  J=J-1
ELSE IF (I.EQ.2) THEN
  J=J-2
ELSE IF (I.EQ.3) THEN
  J=J-3
ELSE
  J=J-4
END IF
```

## Related information

- “IF construct” on page 136
- “END (Construct)” on page 336, for details on the **END IF** statement
- “ELSE” on page 332

---

## ELSEWHERE

### Purpose

The **ELSEWHERE** statement is the first statement of the optional **ELSEWHERE** or masked **ELSEWHERE** block within a **WHERE** construct.

## Syntax

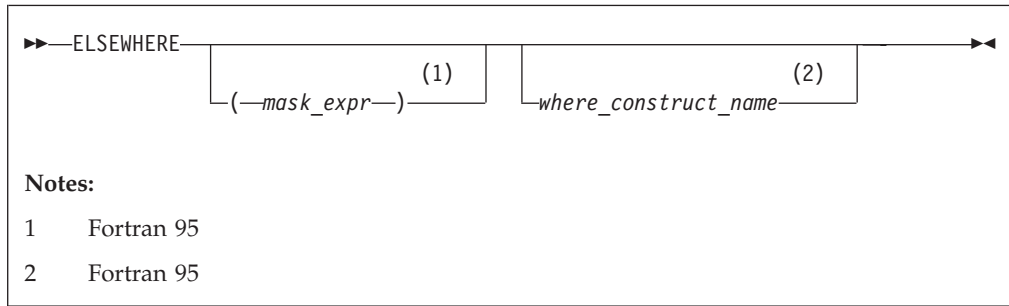

### Fortran 95

*mask\_expr*

is a logical array expression

*where\_construct\_name*

is a name that identifies a **WHERE** construct

End of Fortran 95

## Rules

### Fortran 95

A masked **ELSEWHERE** statement contains a *mask\_expr*. See “Interpreting masked array assignments” on page 115 for information on interpreting mask expressions. Each *mask\_expr* in a **WHERE** construct must have the same shape.

If you specify a *where\_construct\_name*, it must be the same name that you specified on the **WHERE** construct statement.

End of Fortran 95

**ELSEWHERE** and masked **ELSEWHERE** statements must not be branch target statements.

## Examples

The following example shows a program that uses a simple masked **ELSEWHERE** statement to change the data in an array:

```
INTEGER ARR1(3, 3), ARR2(3,3), FLAG(3, 3)
```

```
ARR1 = RESHAPE((/(I, I=1, 9)/), (/3, 3 /))
```

```
ARR2 = RESHAPE((/(I, I=9, 1, -1 /), (/3, 3 /))
```

```
FLAG = -99
```

```
! Data in arrays ARR1, ARR2, and FLAG at this point:
```

```
!
```

```
! ARR1 = | 1  4  7 |  ARR2 = | 9  6  3 |  FLAG = | -99 -99 -99 |  
!       | 2  5  8 |       | 8  5  2 |       | -99 -99 -99 |  
!       | 3  6  9 |       | 7  4  1 |       | -99 -99 -99 |
```

```
WHERE (ARR1 > ARR2)
```

```
  FLAG = 1
```

```
ELSEWHERE (ARR1 == ARR2)
```

```

    FLAG = 0
ELSEWHERE
    FLAG = -1
END WHERE

! Data in arrays ARR1, ARR2, and FLAG at this point:
!
! ARR1 = | 1  4  7 | ARR2 = | 9  6  3 | FLAG = | -1 -1  1 |
!         | 2  5  8 |         | 8  5  2 |         | -1  0  1 |
!         | 3  6  9 |         | 7  4  1 |         | -1  1  1 |

```

## Related information

- “WHERE construct” on page 113
- “WHERE” on page 478
- “END (Construct)” on page 336, for details on the **END WHERE** statement

---

**END**

## Purpose

An **END** statement indicates the end of a program unit or procedure.

## Syntax

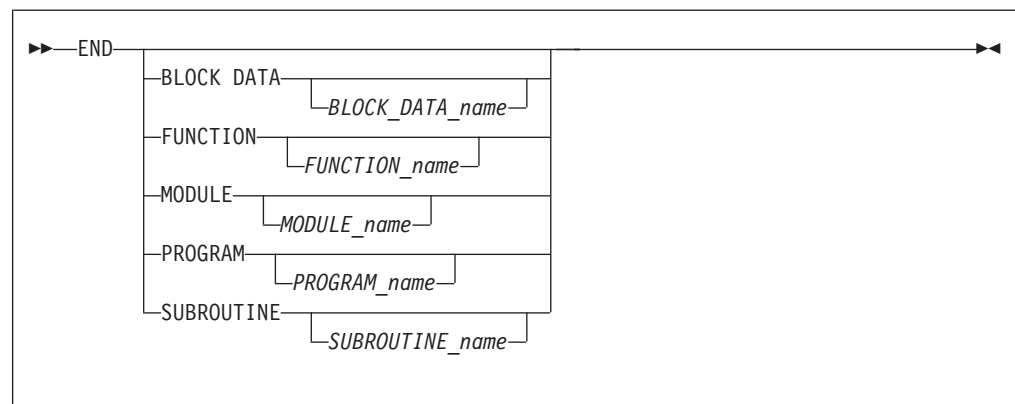

## Rules

The **END** statement is the only required statement in a program unit.

For an internal subprogram or module subprogram, you must specify the **FUNCTION** or **SUBROUTINE** keyword on the **END** statement. For block data program units, external subprograms, the main program, modules and interface bodies, the corresponding keyword is optional.

The program name can be included in the **END PROGRAM** statement only if the optional **PROGRAM** statement is used and if the name is identical to the program name specified in the **PROGRAM** statement.

The block data name can be included in the **END BLOCK DATA** statement only if it is provided in the **BLOCK DATA** statement and if the name is identical to the block data name specified in the **BLOCK DATA** statement.

If a name is specified in an **END MODULE**, **END FUNCTION**, or **END SUBROUTINE** statement, it must be identical to the name specified in the corresponding **MODULE**, **FUNCTION**, or **SUBROUTINE** statement, respectively.

The **END**, **END FUNCTION**, **END PROGRAM**, and **END SUBROUTINE** statements are executable statements that can be branched to. In both fixed source form and Fortran 90 free source form formats, no other statement may follow the **END** statement on the same line. In fixed source form format, you cannot continue a program unit **END** statement, nor can a statement whose initial line appears to be a program unit **END** statement be continued.

The **END** statement of a main program terminates execution of the program. The **END** statement of a function or subroutine has the same effect as a **RETURN** statement. An inline comment can appear on the same line as an **END** statement. Any comment line appearing after an **END** statement belongs to the next program unit.

## Examples

```
PROGRAM TEST
  CALL SUB()
  CONTAINS
    SUBROUTINE SUB
      :
      END SUBROUTINE      ! Reference to subroutine name SUB is optional
END PROGRAM TEST
```

## Related information

- Chapter 8, “Program units and procedures,” on page 145

---

## END (Construct)

### Purpose

The **END (Construct)** statement terminates the execution of a construct. The *Construct Termination Statements* table lists the appropriate statement to end each construct.

Table 34. Construct termination statements

Construct	Termination Statement
ASSOCIATE	END ASSOCIATE
DO DO WHILE	END DO
FORALL	END FORALL
IF	END IF
SELECT CASE SELECT TYPE	END SELECT
WHERE	END WHERE

# Syntax

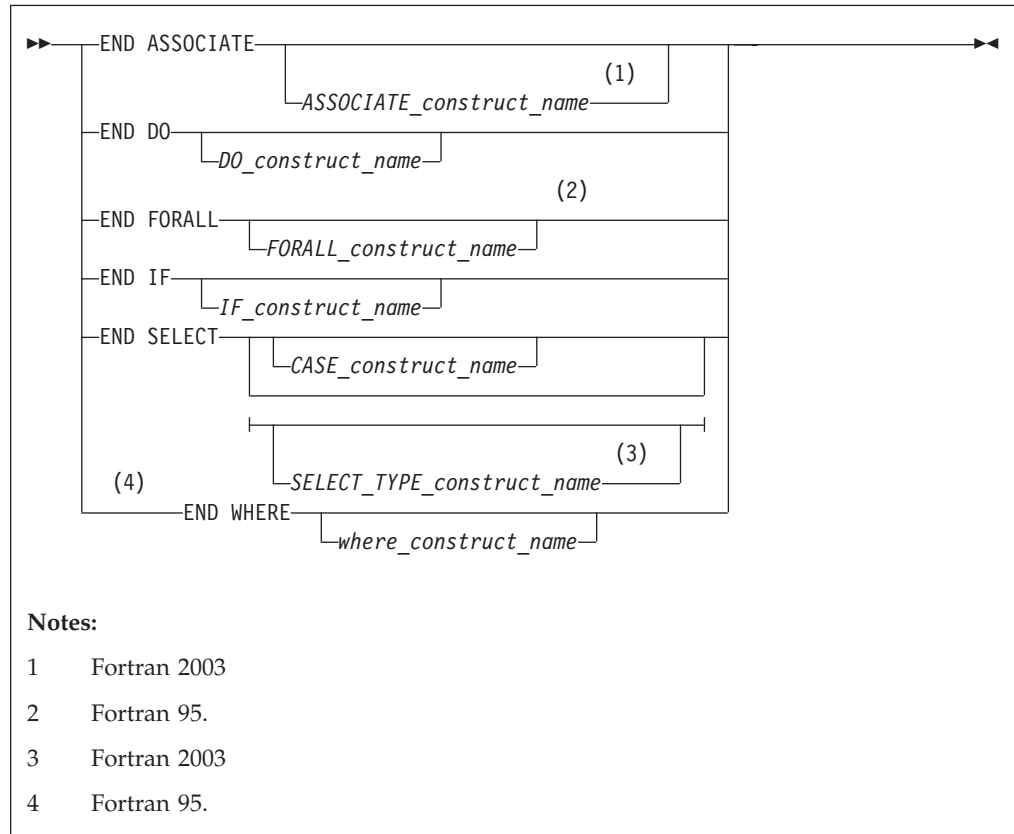

## Fortran 2003

*ASSOCIATE\_construct\_name*

A name that identifies an **ASSOCIATE** construct.

End of Fortran 2003

*DO\_construct\_name*

A name that identifies a **DO** or **DO WHILE** construct.

## Fortran 95

*FORALL\_construct\_name*

A name that identifies a **FORALL** construct.

End of Fortran 95

*IF\_construct\_name*

A name that identifies an **IF** construct.

*CASE\_construct\_name*

A name that identifies a **SELECT CASE** construct.

## Fortran 2003

*SELECT\_TYPE\_construct\_name*

A name that identifies a **SELECT TYPE** construct.

Fortran 95

*where\_construct\_name*

A name that identifies a **WHERE** construct.

End of Fortran 95

## Rules

If you label the **END DO** statement, you can use it as the terminal statement of a labeled or unlabeled **DO** or **DO WHILE** construct. An **END DO** statement terminates the innermost **DO** or **DO WHILE** construct only. If a **DO** or **DO WHILE** statement does not specify a statement label, the terminal statement of the **DO** or **DO WHILE** construct must be an **END DO** statement.

You can branch to an **END ASSOCIATE**, **END DO**, **END IF**, or **END SELECT** statement from within the **ASSOCIATE**, **DO** (or **DO WHILE**), **IF**, or **CASE** construct, respectively. An **END IF** statement can also be branched to from outside of the **IF** construct.

Fortran 95

In Fortran 95, an **END IF** statement cannot be branched to from outside of the **IF** construct.

End of Fortran 95

If you specify a construct name on the statement that begins the construct, the **END** statement that terminates the construct must have the same construct name. Conversely, if you do not specify a construct name on the statement that begins the construct, you must not specify a construct name on the **END** statement.

An **END WHERE** statement must not be a branch target statement.

## Examples

```
INTEGER X(100,100)
DECR: DO WHILE (I.GT.0)
  ...
  IF (J.LT.K) THEN
    ...
    END IF                ! Cannot reference a construct name
    I=I-1
  END DO DECR            ! Reference to construct name DECR mandatory
END
```

The following example shows an invalid use of the *where\_construct\_name*:

```
BW: WHERE (A /= 0)
  B = B + 1
END WHERE EW           ! The where_construct_name on the END WHERE statement
                       ! does not match the where_construct_name on the WHERE
                       ! statement.
```

## Related information

- Chapter 7, “Execution Control,” on page 129
- “ASSOCIATE Construct” on page 129
- “DO” on page 323
- “FORALL” on page 355
- “FORALL (construct) ” on page 358
- “IF (block)” on page 369
- “SELECT CASE” on page 446
- “SELECT TYPE” on page 447
- “WHERE” on page 478
- “Deleted features” on page 818

---

## END INTERFACE

### Purpose

The `END INTERFACE` statement terminates a procedure interface block.

### Syntax

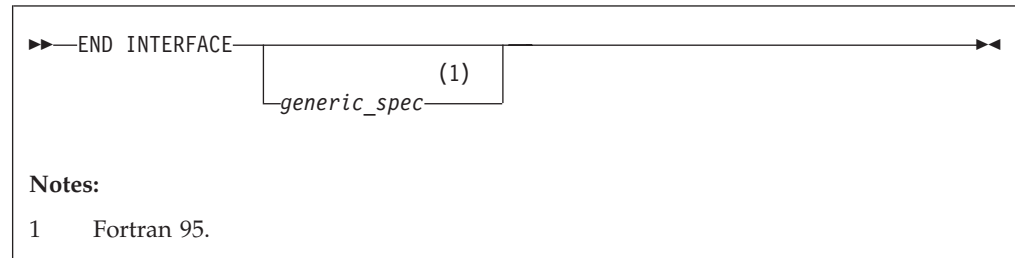

---

#### Fortran 95

*generic\_spec*

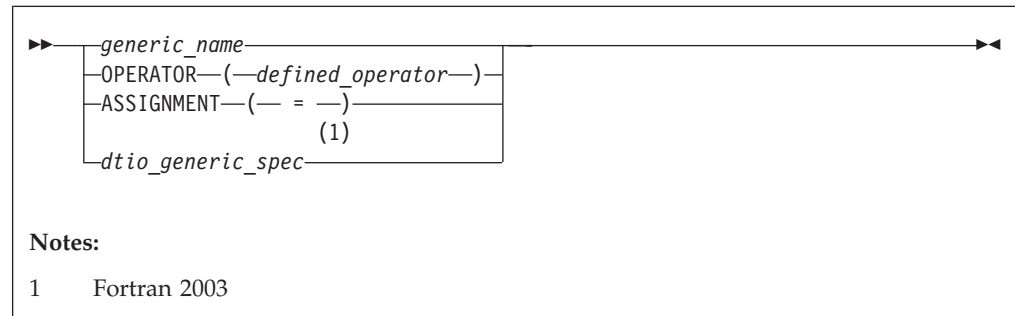

*defined\_operator*

is a defined unary operator, defined binary operator, or extended intrinsic operator

---

#### End of Fortran 95

Fortran 2003

**dtio\_generic\_spec**

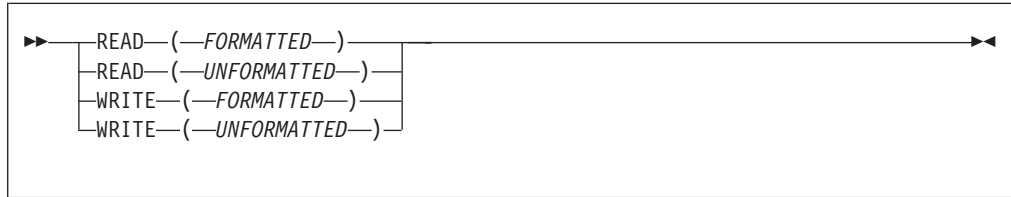

End of Fortran 2003

## Rules

Each **INTERFACE** statement must have a corresponding **END INTERFACE** statement.

An **END INTERFACE** statement without a *generic\_spec* can match any **INTERFACE** statement, with or without a *generic\_spec*.

Fortran 95

If the *generic\_spec* in an **END INTERFACE** statement is a *generic\_name*, the *generic\_spec* of the corresponding **INTERFACE** statement must be the same *generic\_name*.

If the *generic\_spec* in an **END INTERFACE** statement is an **OPERATOR**(*defined\_operator*), the *generic\_spec* of the corresponding **INTERFACE** statement must be the same **OPERATOR**(*defined\_operator*).

If the *generic\_spec* in an **END INTERFACE** statement is an **ASSIGNMENT**(=), the *generic\_spec* for the corresponding **INTERFACE** statement must be the same **ASSIGNMENT**(=).

End of Fortran 95

Fortran 2003

If the *generic\_spec* in an **END INTERFACE** statement is a *dtio\_generic\_spec*, the *generic\_spec* for the corresponding **INTERFACE** statement must be the same *dtio\_generic\_spec*.

End of Fortran 2003

## Examples

```
INTERFACE OPERATOR (.DETERMINANT.)
  FUNCTION DETERMINANT (X)
    INTENT(IN) X
    REAL X(50,50), DETERMINANT
  END FUNCTION
END INTERFACE
```



```

INTERFACE OPERATOR(.INVERSE.)
  FUNCTION INVERSE(Y)
    INTENT(IN) Y
    REAL Y(50,50), INVERSE
  END FUNCTION
END INTERFACE OPERATOR(.INVERSE.)

```

End of Fortran 95

## Related information

- “INTERFACE” on page 389
- “Interface concepts” on page 156

---

## END TYPE

### Purpose

The **END TYPE** statement indicates the completion of a derived-type definition.

### Syntax

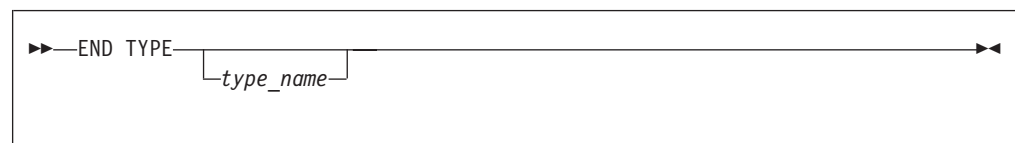

### Rules

If *type\_name* is specified, it must match the *type\_name* in the corresponding **Derived Type** statement.

If a label is specified on the **END TYPE** statement, the label belongs to the scoping unit of the derived-type definition.

### Examples

```

TYPE A
  INTEGER :: B
  REAL :: C
END TYPE A

```

## Related information

- Chapter 4, “Derived Types,” on page 47

---

## ENDFILE

### Purpose

The **ENDFILE** statement writes an endfile record as the next record of an external file connected for sequential access. This record becomes the last record in the file.

An **ENDFILE** statement for a file connected for stream access causes the terminal point to become the current file position. File storage units before the current

position are considered written, and can be read. You can write additional data to the file by using subsequent stream output statements.

Fortran 2003

Execution of an **ENDFILE** statement performs a wait operation for any pending asynchronous data transfer operations for the specified unit.

End of Fortran 2003

## Syntax

```
▶▶ ENDFILE u [ ( position_list ) ] ▶▶
```

*u* is an external unit identifier. The value of *u* must not be an asterisk or a Hollerith constant.

*position\_list*

is a list that must contain one unit specifier (**[UNIT=]***u*) and can also contain one of each of the other valid specifiers:

**[UNIT=]** *u*

is a unit specifier in which *u* must be an external unit identifier whose value is not an asterisk. An external unit identifier refers to an external file that is represented by a scalar integer expression, whose value is in the range 1 through 2147483647. If the optional characters **UNIT=** are omitted, *u* must be the first item in *position\_list*.

Fortran 2003

**IOMSG=** *iormsg\_variable*

is an input/output status specifier that specifies the message returned by the input/output operation. *iormsg\_variable* is a scalar default character variable. It must not be a use-associated nonpointer protected variable. When the input/output statement containing this specifier finishes execution, *iormsg\_variable* is defined as follows:

- If an error, end-of-file, or end-of-record condition occurs, the variable is assigned an explanatory message as if by assignment.
- If no such condition occurs, the value of the variable is unchanged.

End of Fortran 2003

**IOSTAT=** *ios*

is an input/output status specifier that specifies the status of the input/output operation. *ios* is a scalar variable of type **INTEGER(4)** or default integer. When the **ENDFILE** statement finishes executing, *ios* is defined with:

- A zero value if no error condition occurs
- A positive value if an error occurs.

**ERR=** *stmt\_label*

is an error specifier that specifies the statement label of an executable

statement in the same scoping unit to which control is to transfer in the case of an error. Coding the **ERR=** specifier suppresses error messages.

## Rules

### IBM Extension

If the unit is not connected, an implicit **OPEN** specifying sequential access is performed to a default file named **fort.n**, where *n* is the value of *u* with leading zeros removed.

If two **ENDFILE** statements are executed for the same file without an intervening **REWIND** or **BACKSPACE** statement, the second **ENDFILE** statement is ignored.

### End of IBM Extension

After execution of an **ENDFILE** statement for a file connected for sequential access, a **BACKSPACE** or **REWIND** statement must be used to reposition the file prior to execution of any data transfer input/output statement.

If the **ERR=** and **IOSTAT=** specifiers are set and an error is encountered, transfer is made to the statement specified by the **ERR=** specifier and a positive integer value is assigned to *ios*.

### IBM Extension

If **IOSTAT=** and **ERR=** are not specified,

- The program stops if a severe error is encountered.
- The program continues to the next statement if a recoverable error is encountered and the **ERR\_RECOVERY** run-time option is set to **YES**. If the option is set to **NO**, the program stops.

### End of IBM Extension

## Examples

```
ENDFILE 12
ENDFILE (IOSTAT=IOSS,UNIT=11)
```

## Related information

- “Conditions and IOSTAT values” on page 214
- Chapter 9, “XL Fortran Input/Output,” on page 201
- *Setting Run-time Options* in the *XL Fortran Compiler Reference*

---

## ENTRY

### Purpose

A function subprogram or subroutine subprogram has a primary entry point that is established through the **SUBROUTINE** or **FUNCTION** statement. The **ENTRY** statement establishes an alternate entry point for an external subprogram or a module subprogram.

## Syntax

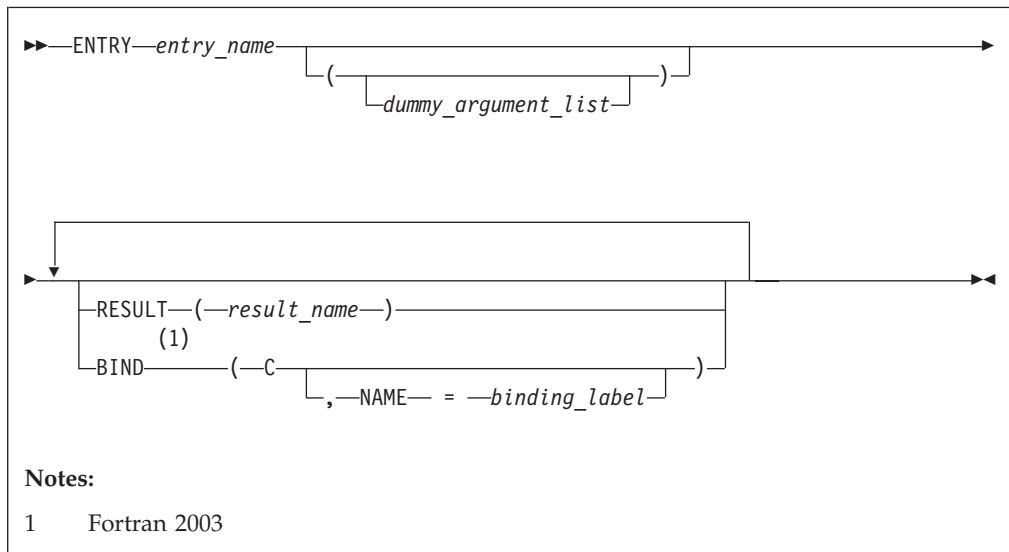

*entry\_name*

is the name of an entry point in a function subprogram or subroutine subprogram

Fortran 2003

*binding\_label*

is a scalar character initialization expression

End of Fortran 2003

## Rules

The **ENTRY** statement cannot appear in a main program, block data program unit, internal subprogram, **IF** construct, **DO** construct, **CASE** construct, derived-type definition, or interface block.

IBM Extension

The **ENTRY** statement cannot appear in a **CRITICAL**, **MASTER**, **PARALLEL**, **PARALLEL SECTIONS**, **SECTIONS**, or **SINGLE** construct.

End of IBM Extension

An **ENTRY** statement can appear anywhere after the **FUNCTION** or **SUBROUTINE** statement (and after any **USE** statements) of an external or module subprogram, except in a statement block within a control construct, in a derived-type definition, or in an interface block. **ENTRY** statements are nonexecutable and do not affect control sequencing during the execution of a subprogram.

The result variable is *result\_name*, if specified; otherwise, it is *entry\_name*. If the characteristics of the **ENTRY** statement's result variable are the same as those of the **FUNCTION** statement's result variable, the result variables identify the same variable, even though they can have different names. Otherwise, they are

storage-associated and must be all nonpointer, nonallocatable scalars of intrinsic (noncharacter) type. *result\_name* can be the same as the result variable name specified for the **FUNCTION** statement or another **ENTRY** statement.

The result variable cannot be specified in a **COMMON**, **DATA**, integer **POINTER**, or **EQUIVALENCE** statement, nor can it have the **PARAMETER**, **INTENT**, **OPTIONAL**, **SAVE**, or **VOLATILE** attributes. The **STATIC** and **AUTOMATIC** attributes can be specified only when the result variable is not an allocatable object, an array or a pointer, and is not of character or derived type.

If the **RESULT** keyword is specified, the **ENTRY** statement must be within a function subprogram, *entry\_name* must not appear in any specification statement in the scope of the function subprogram, and *result\_name* cannot be the same as *entry\_name*.

A result variable must not be initialized in a type declaration statement or **DATA** statement.

The entry name in an external subprogram is a global entity; an entry name in a module subprogram is not a global entity. An interface for an entry can appear in an interface block only when the entry name is used as the procedure name in an interface body.

At most one **RESULT** clause and at most one **BIND** clause may appear. They can appear in any order.

---

**Fortran 2003**

The **BIND** keyword implicitly or explicitly defines a binding label which specifies the name by which an entity is accessed from the C programming language. The result variable, if there is a result, must be a scalar that is interoperable. A binding label cannot be specified for a dummy argument. A dummy argument cannot be zero-sized. A dummy argument for a procedure with the **BIND** attribute must have interoperable types and type parameters, and cannot have the **ALLOCATABLE**, **OPTIONAL**, or **POINTER** attribute.

---

**End of Fortran 2003**

In a function subprogram, *entry\_name* identifies a function and can be referenced as a function from the calling procedure. In a subroutine subprogram, *entry\_name* identifies a subroutine and can be referenced as a subroutine from the calling procedure. When the reference is made, execution begins with the first executable statement following the **ENTRY** statement.

The result variable must be defined prior to exiting from the function, when the function is invoked through that entry.

A name in the *dummy\_argument\_list* must not appear in the following places:

- In an executable statement preceding the **ENTRY** statement unless it also appears in a **FUNCTION**, **SUBROUTINE**, or **ENTRY** statement that precedes the executable statement.
- In the expression of a statement function statement, unless the name is also a dummy argument of the statement function, appears in a **FUNCTION** or **SUBROUTINE** statement, or appears in an **ENTRY** statement that precedes the statement function statement.

The order, number, type, and kind type parameters of the dummy arguments can differ from those of the **FUNCTION** or **SUBROUTINE** statement, or other **ENTRY** statements.

If a dummy argument is used in a specification expression to specify an array bound or character length of an object, you can only specify the object in a statement that is executed during a procedure reference if the dummy argument is present and appears in the dummy argument list of the procedure name referenced.

### Recursion

An **ENTRY** statement can reference itself directly only if the subprogram statement specifies **RECURSIVE** and the **ENTRY** statement specifies **RESULT**. The entry procedure then has an explicit interface within the subprogram. The **RESULT** clause is not required for an entry to reference itself indirectly.

#### Fortran 95

Elemental subprograms can have **ENTRY** statements, but the **ENTRY** statement cannot have the **ELEMENTAL** prefix. The procedure defined by the **ENTRY** statement is elemental if the **ELEMENTAL** prefix is specified in the **SUBROUTINE** or **FUNCTION** statement.

End of Fortran 95

If *entry\_name* is of type character, its length cannot be an asterisk if the function is recursive.

#### IBM Extension

You can also call external procedures recursively when you specify the **-qrecur** compiler option, although XL Fortran disregards this option if a procedure specifies either the **RECURSIVE** or **RESULT** keyword.

End of IBM Extension

## Examples

```
RECURSIVE FUNCTION FNC() RESULT (RES)
  ⋮
  ENTRY ENT () RESULT (RES)           ! The result variable name can be
                                       ! the same as for the function
  ⋮
END FUNCTION
```

## Related information

- “FUNCTION” on page 362
- “SUBROUTINE” on page 453
- “Recursion” on page 195
- “Dummy arguments” on page 182
- **-qrecur** option in the *XL Fortran Compiler Reference*

# ENUM/END ENUM

Fortran 2003

## Purpose

You can specify an **ENUM** statement to define and group a set of named integer constants. The named integer constants in an **ENUM** statement are called enumerators.

## Syntax

To define an enumerator, you must use an enumeration construct:

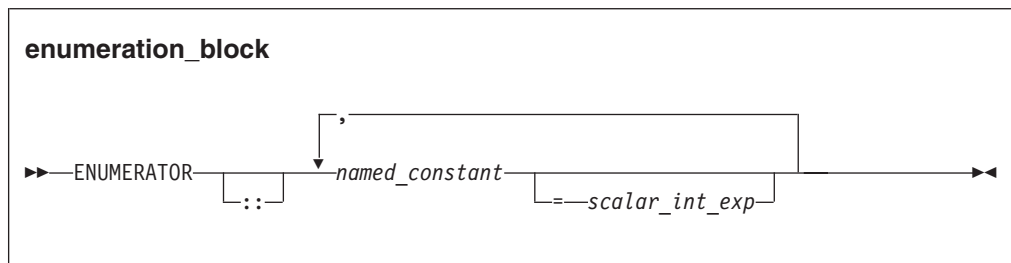
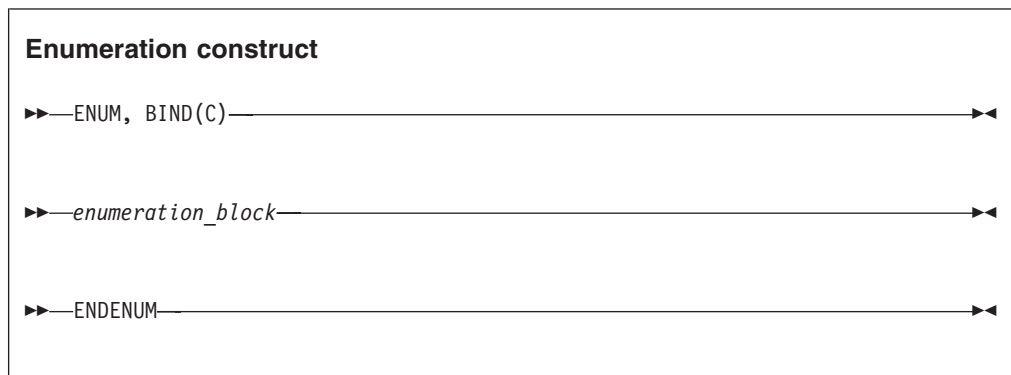

If you want to specify an enumerator with a *scalar\_initialization\_expression*, you must also specify a `::`.

## Rules

If you specify a scalar integer initialization expression, the value of the enumerator is the result of the scalar integer initialization expression.

### IBM Extension

You can only use a logical operator if you compile with **-qintlog**.

### End of IBM Extension

If you do not specify a scalar integer initialization expression and the enumerator is first in the definition body of the type, the value of the enumerator is 0.

If you do not specify a scalar integer initialization expression and the enumerator is after another enumerator in the enumeration definition, the value is one greater than the value of the preceding enumerator.

You can set the kind type parameter of an enumerator using the `-qenum` option. If you do not specify `-qenum`, the default kind for an enumerator is 4.

## Examples

The following example uses the `ENUM` statement in different ways to define enumerators.

### Example of an ENUM statement

```
enum, bind(c)

enumerator :: red =1, blue, black =5
enumerator yellow
enumerator gold, silver, bronze
enumerator :: purple
enumerator :: pink, lavender

endenum
```

The values of these enumerators are: red = 1, blue = 2, black = 5, yellow = 6 , gold = 7, silver = 8, bronze = 9, purple = 10, pink = 11, lavender = 12.

If you supply an initial value for an enumerator, then a `::` is required in the `ENUMERATOR` statement. The *red* and *black* enumerators in the list are initialized with a scalar integer initialization expression.

The `::` is optional in an enumerator definition when scalar integer initialization expressions are not used to initialize any of the enumerators in the list of enumerators being declared:

- In the second and third enumerator definitions, the `::` is not necessary as *yellow*, *gold*, *silver*, and *bronze* are not initialized with a scalar integer initialization expression.
- The fourth and fifth enumerator definitions show that `::` can be used even when *purple* is not initialized with a scalar integer initialization expression.

## Related information

- “PARAMETER” on page 409

End of Fortran 2003

---

## EQUIVALENCE

### Purpose

The `EQUIVALENCE` statement specifies that two or more objects in a scoping unit are to share the same storage.

### Syntax

```
▶▶—EQUIVALENCE—(—equiv_object—,—equiv_object_list—)▶▶
```



*equiv\_object*

is a variable name, array element, or substring. Any subscript or substring expression must be an integer initialization expression. A substring cannot have a length of zero.

## Rules

*equiv\_object* must not be a target, pointer, dummy argument, function name, pointee, entry name, result name, structure component, named constant, automatic data object, allocatable object, object of nonsequence derived type, object of sequence derived type that contains a pointer or allocatable component, or a subobject of any of these.

### Fortran 2003

Variables with the **BIND** attribute, or variables that are members of a common block with the **BIND** attribute must not be objects in an **EQUIVALENCE** statement.

### End of Fortran 2003

Because all items named within a pair of parentheses have the same first storage unit, they become associated. This is called *equivalence association*. It may cause the association of other items as well.

You can specify default initialization for a storage unit that is storage associated. However, the objects or subobjects supplying the default initialization must be of the same type. They must also be of the same type parameters and supply the same value for the storage unit.

If you specify an array element in an **EQUIVALENCE** statement, the number of subscript quantities cannot exceed the number of dimensions in the array. If you specify a multidimensional array using an array element with a single subscript  $n$ , the  $n$  element in the array's storage sequence is specified. In all other cases, XL Fortran replaces any missing subscript with the lower bound of the corresponding dimension of the array. A nonzero-sized array without a subscript refers to the first element of the array.

If *equiv\_object* is of derived type, it must be of a sequence derived type.

### IBM Extension

You can equivalence an object of sequence derived type with any other object of sequence derived type or intrinsic data type provided that the object is allowed in an **EQUIVALENCE** statement.

In XL Fortran, associated items can be of any intrinsic type or of sequence derived type. If they are, the **EQUIVALENCE** statement does not cause type conversion.

### End of IBM Extension

The lengths of associated items do not have to be equal.

Any zero-sized items are storage-associated with one another and with the first storage unit of any nonzero-sized sequences.

An **EQUIVALENCE** statement cannot associate the storage sequences of two different common blocks. It must not specify that the same storage unit is to occur more than once in a storage sequence. An **EQUIVALENCE** statement must not contradict itself or any previously established associations caused by an **EQUIVALENCE** statement.

You can cause names not in common blocks to share storage with a name in a common block using the **EQUIVALENCE** statement.

**Fortran 2003**

If you specify that an object declared by an **EQUIVALENCE** group has the **PROTECTED** attribute, all objects specified in that **EQUIVALENCE** group must have the **PROTECTED** attribute.

**End of Fortran 2003**

You can extend a common block by using an **EQUIVALENCE** statement, but only by adding beyond the last entry, not before the first entry. For example, if the variable that you associate to a variable in a common block, using the **EQUIVALENCE** statement, is an element of an array, the implicit association of the rest of the elements of the array can extend the size of the common block.

## Examples

```
DOUBLE PRECISION A(3)
REAL B(5)
EQUIVALENCE (A,B(3))
```

Association of storage units:

Array A:				A(1)		A(2)		A(3)		
Array B:	B(1)		B(2)		B(3)		B(4)		B(5)	

This example shows how association of two items can result in further association.

```
AUTOMATIC A
CHARACTER A*4,B*4,C(2)*3
EQUIVALENCE (A,C(1)),(B,C(2))
```

Association of storage units:

Variable A:				A					
Variable B:						B			
Array C:			C(1)			C(2)			

Because XL Fortran associates both A and B with C, A and B become associated with each other, and they all have the automatic storage class.

```
INTEGER(4)
G(2,-1:2,-3:2)
REAL(4)      H(3,1:3,2:3)
EQUIVALENCE (G(2),H(1,1)) ! G(2) is G(2,-1,-3)
                          ! H(1,1) is H(1,1,2)
```

## Related information

- “Storage classes for variables” on page 26
- “Definition status of variables” on page 19

---

## EXIT

### Purpose

The **EXIT** statement terminates execution of a **DO** construct or **DO WHILE** construct before the construct completes all of its iterations.

### Syntax

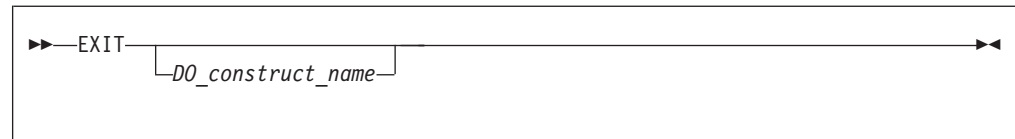

*DO\_construct\_name*

is the name of the **DO** or **DO WHILE** construct

### Rules

The **EXIT** statement is placed within a **DO** or **DO WHILE** construct and belongs to the **DO** or **DO WHILE** construct specified by *DO\_construct\_name* or, if not specified, by the **DO** or **DO WHILE** construct that immediately surrounds it. When a *DO\_construct\_name* is specified, the **EXIT** statement must be in the range of that construct.

When the **EXIT** statement is executed, the **DO** or **DO WHILE** construct that the **EXIT** statement belongs to becomes inactive. If the **EXIT** statement is nested in any other **DO** or **DO WHILE** constructs, they also become inactive. Any **DO** variable present retains its last defined value. If the **DO** construct has no construct control, it will iterate infinitely unless it becomes inactive. The **EXIT** statement can be used to make the construct inactive.

An **EXIT** statement can have a statement label; it cannot be used as the labeled statement that terminates a **DO** or **DO WHILE** construct.

### Examples

```
      LOOP1: DO I = 1, 20
            N = N + 1
10      IF (N > NMAX) EXIT LOOP1          ! EXIT from LOOP1

            LOOP2: DO WHILE (K==1)
                  KMAX = KMAX - 1
20      IF (K > KMAX) EXIT                ! EXIT from LOOP2
            END DO LOOP2

            LOOP3: DO J = 1, 10
                  N = N + 1
30      IF (N > NMAX) EXIT LOOP1          ! EXIT from LOOP1
            EXIT LOOP3                    ! EXIT from LOOP3
            END DO LOOP3

      END DO LOOP1
```

### Related information

- “DO construct” on page 131
- “DO WHILE construct” on page 135

---

# EXTERNAL

## Purpose

The **EXTERNAL** attribute specifies that a name represents an external procedure, a dummy procedure, or a block data program unit. A procedure name with the **EXTERNAL** attribute can be used as an actual argument.

## Syntax

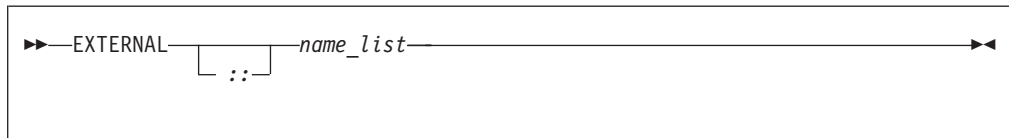

*name* is the name of an external procedure, dummy procedure, or **BLOCK DATA** program unit

## Rules

If an external procedure name or dummy argument name is used as an actual argument, it must be declared with the **EXTERNAL** attribute or by an interface block in the scoping unit, but may not appear in both.

If an intrinsic procedure name is specified with the **EXTERNAL** attribute in a scoping unit, the name becomes the name of a user-defined external procedure. Therefore, you cannot invoke that intrinsic procedure by that name from that scoping unit.

You can specify a name to have the **EXTERNAL** attribute appear only once in a scoping unit.

A name in an **EXTERNAL** statement must not also be specified in a procedure declaration statement or as a specific procedure name in an interface block in the scoping unit.

### Attributes compatible with the **EXTERNAL** attribute

- OPTIONAL
- PRIVATE
- PUBLIC

## Examples

```
PROGRAM MAIN
  EXTERNAL AAA
  CALL SUB(AAA)      ! Procedure AAA is passed to SUB
END

SUBROUTINE SUB(ARG)
  CALL ARG()        ! This results in a call to AAA
END SUBROUTINE
```

## Related information

- “Procedures as dummy arguments” on page 192
- Item 4 under Appendix A, “Compatibility across standards,” on page 815

---

## FLUSH

Fortran 2003

### Purpose

The **FLUSH** statement makes data written to an external file available to other processes, or causes data placed in an external file by means other than Fortran to be available to a **READ** statement.

### Syntax

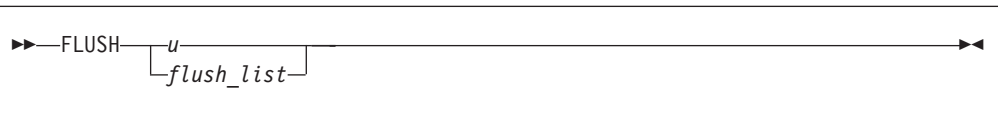

**u** is an integer scalar expression with a value in a range from 0 through 2,147,483,647. This unit references an external file. The value must not be an asterisk or a Hollerith constant.

#### **flush\_list**

a list of specifiers that must contain **UNIT=**, and can also contain one of each of the following specifiers:

- **[UNIT=]** specifies the external file as an integer scalar expression with a value in a range from 0 through 2,147,483,647. The value of must not be an asterisk or a Hollerith constant.
- **ERR=stmt\_label** is an error specifier that specifies the statement label of an executable statement in the same scoping unit to which control is to transfer in the case of an error. Inclusion of the **ERR=** specifier suppresses error messages. *stmt\_label* must be the statement label of a branch target statement that appears in the same scoping unit as the **FLUSH** statement.

Fortran 2003

- **IOMSG=iormsg\_variable** is an input/output status specifier that specifies the message returned by the input/output operation. *iormsg\_variable* is a scalar default character variable. It must not be a use-associated nonpointer protected variable. When the input/output statement containing this specifier finishes execution, *iormsg\_variable* is defined as follows:
  - If an error, end-of-file, or end-of-record condition occurs, the variable is assigned an explanatory message as if by assignment.
  - If no such condition occurs, the value of the variable is unchanged.

End of Fortran 2003

- **IOSTAT=ios** specifies the status of the flush operation as a scalar variable of type **INTEGER**. When execution of the flush statement completes, **ios** is:
  - A zero value if no error condition occurs.
  - A positive value if an error occurs.
  - A negative value if the device cannot perform a flush operation, such as a tape or TTY device.

Inclusion of the **IOSTAT** specifier suppresses error messages. If the program encounters a severe error, the value of *ios* is 200.

If you do not specify **ERR** or **IOSTAT**, the program terminates on encountering a severe error.

## Rules

The **FLUSH** statement must not appear in a pure subprogram.

A **FLUSH** statement has no effect on file position.

The **buffering** run-time option does not affect the execution of the **FLUSH** statement.

## Examples

**Example 1:** The following example includes a Fortran program and a C routine. The program includes a **FLUSH** statement to read the input correctly.

```
! The following Fortran program reads in data from standard input.
program main
  integer, parameter :: N=11
  integer :: rdat(N) /N * -1/
  read(5, *) rdat(1:5)
  FLUSH(5) ! Flush the input buffer
  call csub()
  read(5, *) rdat(6:10)
  print *, rdat
end program
/* The following C routine reads in data. */
#include <stdio.h>
void csub() {
  int dat5;
  setbuf(stdin, NULL); /* specifies no buffering for stdin */
  fscanf(stdin, "%d", &dat5);
  printf("csub: dat5=%d\n", dat5);
}
```

Sample input file:

```
1 2 3 4 5
6
7 8 9 10 11
```

Execution:

```
a.out < infile
```

Sample output:

```
csub: dat5=6
1 2 3 4 5 7 8 9 10 11 -1
```

**Example 2:** In the following example a data file written by a Fortran program is read by a C routine. The program specifies a **FLUSH** statement for the buffered I/O.

```
! The following Fortran program writes data to an external file.
subroutine process_data()
  integer data(10)
  external read_data

  data = ((i,i=1,10)/)
  open(50, file="data_file")
  write(50, *) data
  flush(50)

  call read_data(10)
end subroutine

! write data to an external file
! since Fortran I/O is buffered, a FLUSH
! statement is needed for the C routine to
! to read the data
! call C routine to read the file

/* The following C routine reads data from the external file. */
void read_data(int *sz) {

#include <stdio.h>
#include <stdlib.h>
int *data, i;
  FILE *fp;

  data = (int *) malloc((*sz)*sizeof(int));
  fp = fopen("data_file", "r");
  for (i=0; i<*sz-1; i++) {
    fscanf(fp, "%d", &data[i]);
  }
}
```

## Related information

- Chapter 9, “XL Fortran Input/Output,” on page 201
- “flush\_(lunit)” on page 792
- **Flushing I/O buffers** in the *XL Fortran Optimization and Programming Guide*

End of Fortran 2003

---

## FORALL

Fortran 95

### Purpose

The **FORALL** statement performs assignment to groups of subobjects, especially array elements. Unlike the **WHERE** statement, assignment can be performed on an elemental level rather than on an array level. The **FORALL** statement also allows pointer assignment.

### Syntax

```
►►—FORALL—forall_header—forall_assignment—◄◄
```





## Interpreting the FORALL statement

1. Evaluate the *subscript* and *stride* expressions for each *forall\_triplet\_spec* in any order. All possible pairings of *index\_name* values form the set of combinations. For example, given the following statement:

```
FORALL (I=1:3,J=4:5) A(I,J) = A(J,I)
```

The set of combinations of I and J is:

```
{(1,4),(1,5),(2,4),(2,5),(3,4),(3,5)}
```

The **-1** and **-qnozerosize** compiler options do not affect this step.

2. Evaluate the *scalar\_mask\_expr* for the set of combinations, in any order, producing a set of active combinations (those for which *scalar\_mask\_expr* evaluated to `.TRUE.`). For example, if the mask `(I+J.NE.6)` is applied to the above set, the set of active combinations is:

```
{(1,4),(2,5),(3,4),(3,5)}
```

3. For *assignment\_statement*, evaluate, in any order, all values in the right-hand side *expression* and all subscripts, strides, and substring bounds in the left-hand side *variable* for all active combinations of *index\_name* values.

For *pointer\_assignment*, determine, in any order, what will be the targets of the pointer assignment and evaluate all subscripts, strides, and substring bounds in the pointer for all active combinations of *index\_name* values. Whether or not the target is a pointer, the determination of the target does not include evaluation of its value.

4. For *assignment\_statement*, assign, in any order, the computed *expression* values to the corresponding *variable* entities for all active combinations of *index\_name* values.

For *pointer\_assignment*, associate, in any order, all targets with the corresponding pointer entities for all active combinations of *index\_name* values.

## Loop parallelization

The **FORALL** statement and **FORALL** construct are designed to allow for parallelization of assignment statements. When executing an assignment statement in a **FORALL**, the assignment of an object will not interfere with the assignment of another object. In the next example, the assignments to elements of A can be executed in any order without changing the results:

```
FORALL (I=1:3,J=1:3) A(I,J)=A(J,I)
```

### IBM Extension

The **INDEPENDENT** directive asserts that each iteration of a **DO** loop or each operation in a **FORALL** statement or **FORALL** construct can be executed in any order without affecting the semantics of the program. The operations in a **FORALL** statement or **FORALL** construct are defined as:

- The evaluation of *mask*
- The evaluation of the right-hand side and/or left-hand side indexes
- The evaluation of assignments

Thus, the following loop,

```
      INTEGER, DIMENSION(2000) :: a
!IBM* INDEPENDENT
      FORALL (i=1:1999:2) a(i) = a(i+1)
```

is semantically equivalent to the following array assignment:

```

INTEGER, DIMENSION(2000) :: A
A(1:1999:2) = A(2:2000:2)

```

**Tip**

If it is possible and beneficial to make a specific **FORALL** parallel, specify the **INDEPENDENT** directive before the **FORALL** statement. Because XL Fortran may not always be able to determine whether it is legal to parallelize a **FORALL**, the **INDEPENDENT** directive provides an assertion that it is legal.

End of IBM Extension

## Examples

```

INTEGER A(1000,1000), B(200)
I=17
FORALL (I=1:1000,J=1:1000,I.NE.J) A(I,J)=A(J,I)
PRINT *, I      ! The value 17 is printed because the I
                ! in the FORALL has statement scope.
FORALL (N=1:200:2) B(N)=B(N+1)
END

```

## Related information

- “Intrinsic assignment” on page 110
- “Data pointer assignment” on page 123
- “FORALL construct” on page 120
- “INDEPENDENT ” on page 500
- “Statement and construct entities” on page 148

End of Fortran 95

## FORALL (construct)

Fortran 95

### Purpose

The **FORALL (Construct)** statement is the first statement of the **FORALL** construct.

### Syntax

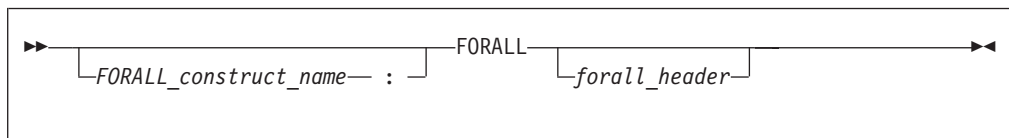

*forall\_header*

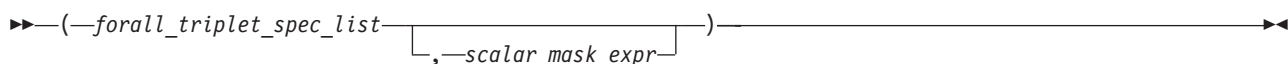

*forall\_triplet\_spec*

▶▶—*index\_name*— = —*subscript*— : —*subscript*—  
  └ : —*stride*—┘

*scalar\_mask\_expr*  
is a scalar logical expression

*subscript, stride*  
are both scalar integer expressions

## Rules

Any procedures that are referenced in the mask expression of *forall\_header* (including one referenced by a defined operation or assignment) must be pure.

The *index\_name* must be a scalar integer variable. The scope of *index\_name* is the whole **FORALL** construct.

In *forall\_triplet\_spec\_list*, neither a *subscript* nor a *stride* can contain a reference to any *index\_name* in the *forall\_triplet\_spec\_list*. Evaluation of any expression in *forall\_header* must not affect evaluation of any other expression in *forall\_header*.

Given the following *forall\_triplet\_spec*:

*index1* = *s1:s2:s3*

The maximum number of index values is determined by:

$max = \text{INT}((s2-s1+s3)/s3)$

If the stride (*s3* above) is not specified, a value of 1 is assumed. If  $max \leq 0$  for any index, *forall\_assignment* is not executed. For example:

```
index1 = 2:10:3      ! The index values are 2,5,8.  
                   ! max = floor(((10-2)/3)+1) = 3.  
  
index2 = 6:2:-1     ! The index values are 6,5,4,3,2.  
index2 = 6:2       ! No index values.
```

If the mask expression is omitted, a value of **.TRUE.** is assumed.

## Examples

```
POSITIVE: FORALL (X=1:100,A(X)>0)  
  I(X)=I(X)+J(X)  
  J(X)=J(X)-I(X+1)  
END FORALL POSITIVE
```

## Related information

- “END (Construct)” on page 336
- “FORALL construct” on page 120
- “Statement and construct entities” on page 148

End of Fortran 95

---

# FORMAT

## Purpose

The **FORMAT** statement provides format specifications for input/output statements.

## Syntax

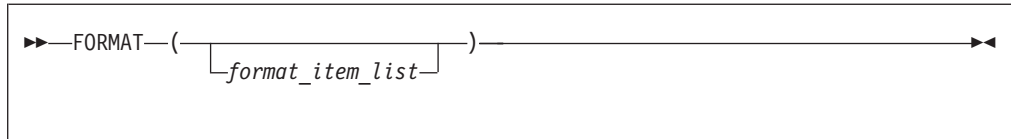

*format\_item*



*r* is an unsigned, positive, integer literal constant that cannot specify a kind type parameter, or it is a scalar integer expression enclosed by angle brackets (< and >). It is called a repeat specification. It specifies the number of times to repeat the *format\_item\_list* or the *data\_edit\_desc*. The default is 1.

*data\_edit\_desc*  
is a data edit descriptor

*control\_edit\_desc*  
is a control edit descriptor

*char\_string\_edit\_desc*  
is a character string edit descriptor

## Rules

When a format identifier in a formatted **READ**, **WRITE**, or **PRINT** statement is a statement label or a variable that is assigned a statement label, the statement label identifies a **FORMAT** statement.

The **FORMAT** statement must have a statement label. **FORMAT** statements cannot appear in block data program units, interface blocks, the scope of a module, or derived-type definitions.

Commas separate edit descriptors. You can omit the comma between a **P** edit descriptor and an **F**, **E**, **EN**, **ES**, **D**, **G**, or **Q** (both extended precision and character count) edit descriptor immediately following it, before a slash edit descriptor when the optional repeat specification is not present, after a slash edit descriptor, and before or after a colon edit descriptor.

**FORMAT** specifications can also be given as character expressions in input/output statements.

XL Fortran treats uppercase and lowercase characters in format specifications the same, except in character string edit descriptors.

### Character format specification

When a format identifier in a formatted **READ**, **WRITE**, or **PRINT** statement is a character array name or character expression, the value of the array or expression is a character format specification.

If the format identifier is a character array element name, the format specification must be completely contained within the array element. If the format identifier is a character array name, the format specification can continue beyond the first element into following consecutive elements.

Blanks can precede the format specification. Character data can follow the right parenthesis that ends the format specification without affecting the format specification.

#### Variable format expressions:

#### IBM Extension

Wherever an integer constant is required by an edit descriptor, you can specify an integer expression in a **FORMAT** statement. The integer expression must be enclosed by angle brackets (< and >). You cannot use a sign outside of a variable format expression. The following are valid format specifications:

```

WRITE(6,20) INT1
20  FORMAT(I<MAX(20,5)>)

WRITE(6,FMT=30) INT2, INT3
30  FORMAT(I<J+K>,I<2*M>)

```

The integer expression can be any valid Fortran expression, including function calls and references to dummy arguments, with the following restrictions:

- Expressions cannot be used with the **H** edit descriptor
- Expressions cannot contain graphical relational operators.

The value of the expression is reevaluated each time an input/output item is processed during the execution of the **READ**, **WRITE**, or **PRINT** statement.

#### End of IBM Extension

## Examples

```

CHARACTER*32 CHARVAR
CHARVAR=('integer: ',I2,' binary: ',B8)" ! Character format
M = 56 ! specification
J = 1 ! OUTPUT:
X = 2355.95843 !
WRITE (6,770) M,X ! 56 2355.96
WRITE (6,CHARVAR) M,M ! integer: 56
! binary: 00111000
WRITE (6,880) J,M ! 1
! 56

770 FORMAT(I3, 2F10.2)
880 FORMAT(I<J+1>)
END

```

## Related information

- Chapter 10, “Input/Output formatting,” on page 223
- “PRINT” on page 414
- “READ” on page 425
- “WRITE” on page 481

## FUNCTION

### Purpose

The **FUNCTION** statement is the first statement of a function subprogram.

### Syntax

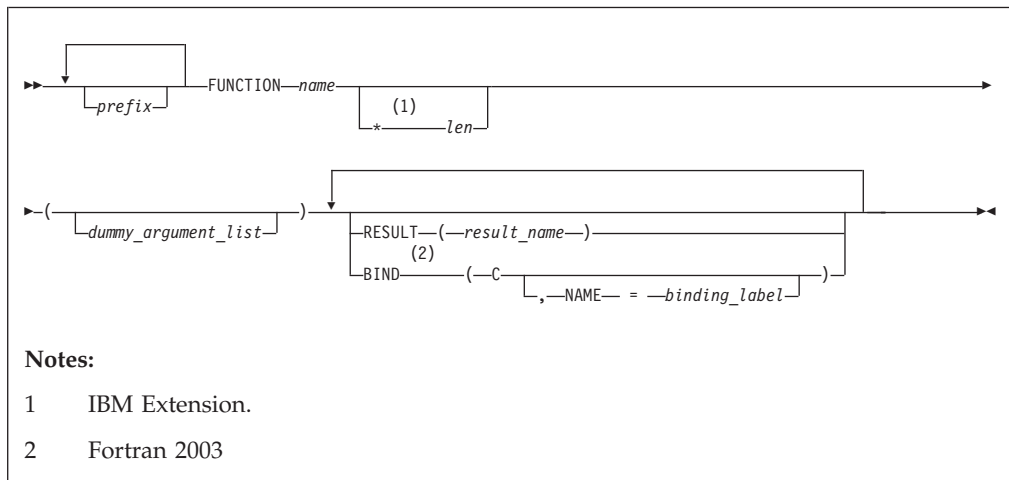

*prefix* is one of the following:

*declaration\_type\_spec*

**RECURSIVE**

**F95** **PURE**  **F95**  
 **F95** **ELEMENTAL**  **F95**

*declaration\_type\_spec*

specifies the type and type parameters of the function result. See “Type Declaration” on page 461 for details about *declaration\_type\_spec*.

*name* The name of the function subprogram

#### IBM Extension

*len* An unsigned integer literal or a parenthesized scalar integer initialization expression. The value of *len* specifies the length of the function’s result variable. It can be included only when you specify the type in the **FUNCTION** statement. The type cannot be **DOUBLE PRECISION**, **DOUBLE COMPLEX**, **BYTE**, or a derived type.

End of IBM Extension

#### Fortran 2003

*binding\_label*

a scalar character initialization expression

End of Fortran 2003

## Rules

At most one of each kind of *prefix* can be specified.

At most one **RESULT** clause and at most one **BIND** clause may appear. They can appear in any order.

The type and type parameters of the function result can be specified by either *declaration\_type\_spec* or by declaring the result variable in the declaration part of the function subprogram, but not by both. If they are not specified at all, the implicit typing rules are in effect. A length specifier cannot be specified by both *declaration\_type\_spec* and *len*.

If **RESULT** is specified, *result\_name* becomes the function result variable. *name* must not be declared in any specification statement in the subprogram, although it can be referenced. *result\_name* must not be the same as *name*. If **RESULT** is not specified, *name* becomes the function result variable.

Fortran 2003

The **BIND** keyword implicitly or explicitly defines a binding label by which a procedure is accessed from the C programming language. The result variable must be a scalar that is interoperable. A dummy argument cannot be zero-sized. A dummy argument for a procedure with the **BIND** attribute must have interoperable types and type parameters, and cannot have the **ALLOCATABLE**, **OPTIONAL**, or **POINTER** attribute.

The **BIND** attribute must not be specified for an internal procedure. If the **FUNCTION** statement appears as part of an interface body that describes a dummy procedure, the **NAME=** specifier must not appear. An elemental procedure cannot have the **BIND** attribute.

End of Fortran 2003

If the result variable is an array or pointer, the **DIMENSION** or **POINTER** attributes, respectively, must be specified within the function body.

If the function result is a pointer, the shape of the result variable determines the shape of the value returned by the function. If the result variable is a pointer, the function must either associate a target with the pointer or define the association status of the pointer as disassociated.

If the result variable is not a pointer, the function must define its value.

If the name of an external function is of derived type, the derived type must be a sequence derived type if the type is not use-associated or host-associated.

The function result variable must not appear within a variable format expression, nor can it be specified in a **COMMON**, **DATA**, integer **POINTER**, or **EQUIVALENCE** statement, nor can it have the **PARAMETER**, **INTENT**, **OPTIONAL**, or **SAVE** attributes. The **STATIC** and **AUTOMATIC** attributes can be

specified only when the result variable is not an allocatable object, an array or a pointer, and is not of character or derived type.

The function result variable is associated with any entry procedure result variables. This is called entry association. The definition of any of these result variables becomes the definition of all the associated variables having that same type, and is the value of the function regardless of the entry point.

If the function subprogram contains entry procedures, the result variables are not required to be of the same type unless the type is of character or derived type, or if the variables have the **ALLOCATABLE** or **POINTER** attribute, or if they are not scalars. The variable whose name is used to reference the function must be in a defined state when a **RETURN** or **END** statement is executed in the subprogram. An associated variable of a different type must not become defined during the execution of the function reference, unless an associated variable of the same type redefines it later during execution of the subprogram.

### Recursion

The **RECURSIVE** keyword must be specified if, directly or indirectly:

- The function invokes itself
- The function invokes a function defined by an **ENTRY** statement in the same subprogram
- An entry procedure in the same subprogram invokes itself
- An entry procedure in the same subprogram invokes another entry procedure in the same subprogram
- An entry procedure in the same subprogram invokes the subprogram defined by the **FUNCTION** statement.

A function that directly invokes itself requires that both the **RECURSIVE** and **RESULT** keywords be specified. The presence of both keywords makes the procedure interface explicit within the subprogram.

If *name* is of type character, its length cannot be an asterisk if the function is recursive.

#### IBM Extension

If **RECURSIVE** is specified, the result variable has a default storage class of automatic.

You can also call external procedures recursively when you specify the **-qrecur** compiler option, although XL Fortran disregards this option if the **FUNCTION** statement specifies either **RECURSIVE** or **RESULT**.

End of IBM Extension

### Elemental procedures

#### Fortran 95

For elemental procedures, the keyword **ELEMENTAL** must be specified. If the **ELEMENTAL** keyword is specified, the **RECURSIVE** keyword cannot be specified.

End of Fortran 95





*stmt\_label*

is the statement label of an executable statement in the same scoping unit as the assigned **GO TO**. The same statement label can appear more than once in *stmt\_label\_list*.

## Rules

When the assigned **GO TO** statement is executed, the variable you specify by *variable\_name* with the value of a statement label must be defined. You must establish this definition with an **ASSIGN** statement in the same scoping unit as the assigned **GO TO** statement. If the integer variable is a dummy argument in a subprogram, you must assign it a statement label in the subprogram in order to use it in an assigned **GO TO** in that subprogram. Execution of the assigned **GO TO** statement transfers control to the statement identified by that statement label.

If *stmt\_label\_list* is present, the statement label assigned to the variable specified by *variable\_name* must be one of the statement labels in the list.

The assigned **GO TO** cannot be the terminal statement of a **DO** or **DO WHILE** construct.

Fortran 95

The assigned **GO TO** statement has been deleted in Fortran 95.

End of Fortran 95

## Examples

```
      INTEGER RETURN_LABEL
      .
      .
      .
! Simulate a call to a local procedure
      ASSIGN 100 TO RETURN_LABEL
      GOTO 9000
100  CONTINUE
      .
      .
      .
9000 CONTINUE
! A "local" procedure
      .
      .
      .
      GOTO RETURN_LABEL
```

## Related information

- “Statement labels” on page 7
- “Branching” on page 142
- “Deleted features” on page 818

---

## GO TO (computed)

### Purpose

The computed **GO TO** statement transfers program control to one of possibly several executable statements.

## Syntax

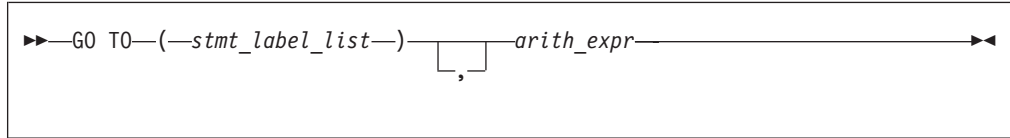

*stmt\_label*

is the statement label of an executable statement in the same scoping unit as the computed **GO TO**. The same statement label can appear more than once in *stmt\_label\_list*.

*arith\_expr*

is a scalar integer expression.

### IBM Extension

It can also be real or complex. If the value of the expression is noninteger, XL Fortran converts it to **INTEGER(4)** before using it.

End of IBM Extension

## Rules

When a computed **GO TO** statement is executed, the *arith\_expr* is evaluated. The resulting value is used as an index into *stmt\_label\_list*. Control then transfers to the statement whose statement label you identify by the index. For example, if the value of *arith\_expr* is 4, control transfers to the statement whose statement label is fourth in the *stmt\_label\_list*, provided there are at least four labels in the list.

If the value of *arith\_expr* is less than 1 or greater than the number of statement labels in the list, the **GO TO** statement has no effect (like a **CONTINUE** statement), and the next statement is executed.

## Examples

```
INTEGER NEXT
...
GO TO (100,200) NEXT
10 PRINT *, 'Control transfers here if NEXT does not equal 1 or 2'
...
100 PRINT *, 'Control transfers here if NEXT = 1'
...
200 PRINT *, 'Control transfers here if NEXT = 2'
```

## Related information

- “Statement labels” on page 7
- “Branching” on page 142

---

## GO TO (unconditional)

### Purpose

The unconditional **GO TO** statement transfers program control to a specified executable statement.

## Syntax

```
▶▶—GO TO—stmt_label—▶▶
```

*stmt\_label*

is the statement label of an executable statement in the same scoping unit as the unconditional **GO TO**

## Rules

The unconditional **GO TO** statement transfers control to the statement identified by *stmt\_label*.

The unconditional **GO TO** statement cannot be the terminal statement of a **DO** or **DO WHILE** construct.

## Examples

```
REAL(8) :: X,Y  
GO TO 10  
...  
10 PRINT *, X,Y  
END
```

## Related information

- “Statement labels” on page 7
- “Branching” on page 142

---

## IF (arithmetic)

### Purpose

The arithmetic **IF** statement transfers program control to one of three executable statements, depending on the evaluation of an arithmetic expression.

### Syntax

```
▶▶—IF—(arith_expr)—stmt_label1—,—stmt_label2—,—stmt_label3—▶▶
```

*arith\_expr*

is a scalar arithmetic expression of type integer or real

*stmt\_label1*, *stmt\_label2*, and *stmt\_label3*

are statement labels of executable statements within the same scoping unit as the **IF** statement. The same statement label can appear more than once among the three statement labels.

## Rules

The arithmetic **IF** statement evaluates *arith\_expr* and transfers control to the statement identified by *stmt\_label1*, *stmt\_label2*, or *stmt\_label3*, depending on whether the value of *arith\_expr* is less than zero, zero, or greater than zero, respectively.

## Examples

```
          IF (K-100) 10,20,30
10      PRINT *, 'K is less than 100.'
          GO TO 40
20      PRINT *, 'K equals 100.'
          GO TO 40
30      PRINT *, 'K is greater than 100.'
40      CONTINUE
```

## Related information

- “Branching” on page 142
- “Statement labels” on page 7

---

## IF (block)

### Purpose

The block **IF** statement is the first statement in an **IF** construct.

### Syntax

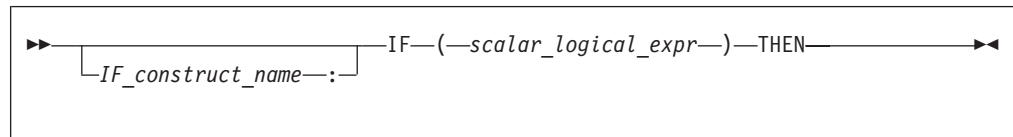

*IF\_construct\_name*

Is a name that identifies the **IF** construct.

### Rules

The block **IF** statement evaluates a logical expression and executes at most one of the blocks contained within the **IF** construct.

If the *IF\_construct\_name* is specified, it must appear on the **END IF** statement, and optionally on any **ELSE IF** or **ELSE** statements in the **IF** construct.

### Examples

```
WHICHC: IF (CMD .EQ. 'RETRY') THEN
          IF (LIMIT .GT. FIVE) THEN           ! Nested IF constructs
          ...
          CALL STOP
        ELSE
          CALL RETRY
        END IF
ELSE IF (CMD .EQ. 'STOP') THEN WHICHC
        CALL STOP
ELSE IF (CMD .EQ. 'ABORT') THEN
```

```
CALL ABORT
ELSE WHICHC
GO TO 100
END IF WHICHC
```

## Related information

- “IF construct” on page 136
- “ELSE IF” on page 333
- “ELSE” on page 332
- “END (Construct)” on page 336, for details on the **END IF** statement

---

## IF (logical)

### Purpose

The logical **IF** statement evaluates a logical expression and, if true, executes a specified statement.

### Syntax

```
▶▶—IF—(—logical_expr—)—stmt—▶▶
```

*logical\_expr*

is a scalar logical expression

*stmt*

is an unlabeled executable statement

### Rules

When a logical **IF** statement is executed, the *logical\_expr* is evaluated. If the value of *logical\_expr* is true, *stmt* is executed. If the value of *logical\_expr* is false, *stmt* does not execute and the **IF** statement has no effect (like a **CONTINUE** statement).

Execution of a function reference in *logical\_expr* can change the values of variables that appear in *stmt*.

*stmt* cannot be a **SELECT CASE**, **CASE**, **END SELECT**, **DO**, **DO WHILE**, **END DO**, block **IF**, **ELSE IF**, **ELSE**, **END IF**, **END FORALL**, another logical **IF**, **ELSEWHERE**, **END WHERE**, **END**, **END FUNCTION**, **END SUBROUTINE** statement, **ASSOCIATE** construct statement, **FORALL** construct statement, or **WHERE** construct statement.

### Examples

```
IF (ERR.NE.0) CALL ERROR(ERR)
```

## Related information

- Chapter 7, “Execution Control,” on page 129

# IMPLICIT

## Purpose

The **IMPLICIT** statement changes or confirms the default implicit typing or the default storage class for local entities or, with the form **IMPLICIT NONE** specified, voids the implicit type rules altogether.

## Syntax

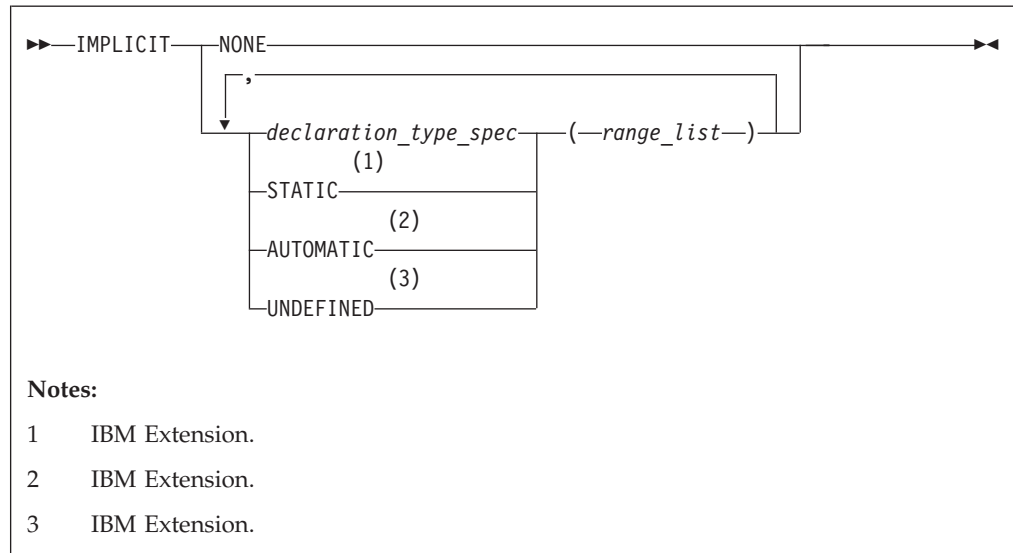

*declaration\_type\_spec*

specifies a data type. See “Type Declaration” on page 461.

*range*

is either a single letter or range of letters. A range of letters has the form *letter<sub>1</sub>-letter<sub>2</sub>*, where *letter<sub>1</sub>* is the first letter in the range and *letter<sub>2</sub>*, which follows *letter<sub>1</sub>* alphabetically, is the last letter in the range. Dollar sign (\$) and underscore (\_) are also permitted in a range. The underscore ( ) follows the dollar sign (\$), which follows the Z. Thus, the range Y - \_ is the same as Y, Z, \$, \_.

## Rules

Letter ranges cannot overlap; that is, no more than one type can be specified for a given letter.

In a given scoping unit, if a character has not been specified in an **IMPLICIT** statement, the implicit type for entities in a program unit or interface body is default integer for entities that begin with the characters I-N, and default real otherwise. The default for an internal or module procedure is the same as the implicit type used by the host scoping unit.

For any data entity name that begins with the character specified by *range\_list*, and for which you do not explicitly specify a type, the type specified by the immediately preceding *declaration\_type\_spec* is provided. Note that implicit typing can be to a derived type that is inaccessible in the local scope if the derived type is

accessible to the host scope.

IBM Extension

A type specified in an **IMPLICIT** statement must not be a **VECTOR** type.

A character or a range of characters that you specify as **STATIC** or **AUTOMATIC** can also appear in an **IMPLICIT** statement for any data type. A letter in a *range\_list* cannot have both *declaration\_type\_spec* and **UNDEFINED** specified for it in the scoping unit. Neither can both **STATIC** and **AUTOMATIC** be specified for the same letter.

End of IBM Extension

If you specify the form **IMPLICIT NONE** in a scoping unit, you must use type declaration statements to specify data types for names local to that scoping unit. You cannot refer to a name that does not have an explicitly defined data type; this lets you control all names that are inadvertently referenced. When **IMPLICIT NONE** is specified, you cannot specify any other **IMPLICIT** statement in the same scoping unit, except ones that contain **STATIC** or **AUTOMATIC**. You can compile your program with the **-qundef** compiler option to achieve the same effect as an **IMPLICIT NONE** statement appearing in each scoping unit where an **IMPLICIT** statement is allowed.

IBM Extension

**IMPLICIT UNDEFINED** turns off the implicit data typing defaults for the character or range of characters specified. When you specify **IMPLICIT UNDEFINED**, you must declare the data types of all symbolic names in the scoping unit that start with a specified character. The compiler issues a diagnostic message for each symbolic name local to the scoping unit that does not have an explicitly defined data type.

End of IBM Extension

An **IMPLICIT** statement does not change the data type of an intrinsic function.

IBM Extension

Using the **-qsave/-qnosave** compiler option modifies the predefined conventions for storage class:

<b>-qsave</b> compiler option	makes the predefined convention	<b>IMPLICIT STATIC</b> ( a - _ )
<b>-qnosave</b> compiler option	makes the predefined convention	<b>IMPLICIT AUTOMATIC</b> ( a - _ )

Even if you specified the **-qmixed** compiler option, the range list items are not case sensitive. For example, with **-qmixed** specified, **IMPLICIT INTEGER(A)** affects the implicit typing of data objects that begin with **A** as well as those that begin with **a**.

End of IBM Extension



## Examples

```
      IMPLICIT INTEGER (B), COMPLEX (D, K-M), REAL (R-Z,A)
! This IMPLICIT statement establishes the following
! implicit typing:
!
!       A: real
!       B: integer
!       C: real
!       D: complex
!     E to H: real
!     I, J: integer
!     K, L, M: complex
!     N: integer
!     O to Z: real
!     $: real
!     _: real
```

## Related information

- “Determining Type” on page 17 for a discussion of the implicit rules
- “Storage classes for variables” on page 26
- `-qundef` option in the *XL Fortran Compiler Reference*
- `-qsave` option in the *XL Fortran Compiler Reference*

---

## IMPORT

Fortran 2003

### Purpose

The **IMPORT** statement makes named entities from the host scoping unit accessible in the interface body by host association.

### Syntax

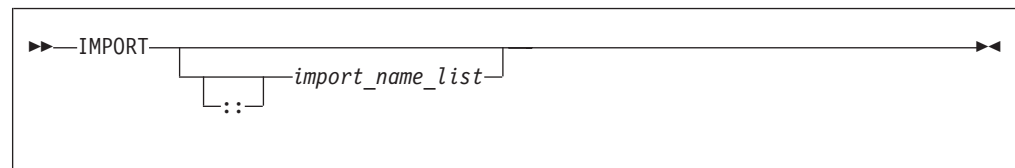

*import\_name\_list*

is a list of named entities that are accessible in the host scoping unit

### Rules

The **IMPORT** statement is allowed only in an interface body. Each of the specified names must be explicitly declared before the interface body.

The entities in the import name list are imported into the current scoping unit and are accessible by host association. If no names are specified, all of the accessible named entities in the host scoping unit are imported.

The names of imported entities must not appear in any context that would cause the host entity to be inaccessible.

## Examples

```
use, intrinsic :: ISO_C_BINDING
interface
  subroutine process_buffer(buffer, n_bytes), bind(C,NAME="ProcessBuffer")
    IMPORT :: C_PTR, C_INT
    type (C_PTR), value :: buffer
    integer (C_INT), value :: n_bytes
  end subroutine process_buffer
end interface
.....
```

## Related information

- “INTERFACE” on page 389
- “Host association” on page 150
- “Interface concepts” on page 156

End of Fortran 2003

---

## INQUIRE

### Purpose

The **INQUIRE** statement obtains information about the properties of a named file or the connection to a particular unit.

There are three forms of the **INQUIRE** statement:

- Inquire by file, which requires the **FILE=** specifier.
- Inquire by output list, which requires the **IOLENGTH=** specifier
- Inquire by unit, which requires the **UNIT=** specifier.

### Syntax

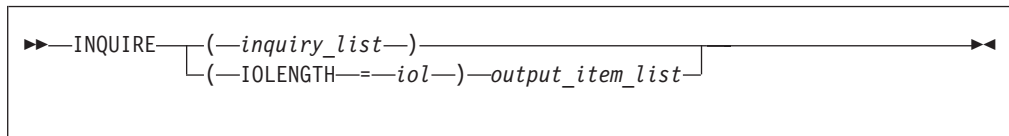

*iol* indicates the number of bytes of data that would result from the use of the output list in an unformatted output statement. *iol* is a scalar integer variable.

*output\_item*

See the **PRINT** or **WRITE** statement

*inquiry\_list*

is a list of inquiry specifiers for the inquire-by-file and inquire-by-unit forms of the **INQUIRE** statement. The inquire-by-file form cannot contain a unit specifier, and the inquire-by-unit form cannot contain a file specifier. No specifier can appear more than once in any **INQUIRE** statement. The inquiry specifiers are:

**[UNIT=]** *u*

is a unit specifier. It specifies the unit about which the inquire-by-unit form of the statement is inquiring. *u* must be an external unit identifier whose value is not an asterisk. An external unit identifier refers to an external file

that is represented by an integer expression, whose value is in the range 0 through 2147483647. If the optional characters **UNIT=** are omitted, *u* must be the first item in *inquiry\_list*.

**ACCESS=** *char\_var*

indicates whether the file is connected for direct access, sequential access, **F2003** or stream access. **F2003** *char\_var* is a scalar character variable that is assigned the value **SEQUENTIAL** if the file is connected for sequential access. The value assigned is **DIRECT** if the file is connected for direct access. **F2003** The value assigned is **STREAM** if the file is connected for stream access. **F2003** If there is no connection, *char\_var* is assigned the value **UNDEFINED**.

**ACTION=** *act*

indicates if the file is connected for read and/or write access. *act* is a scalar character variable that is assigned the value **READ** if the file is connected for input only, **WRITE** if the file is connected for output only, **READWRITE** if the file is connected for both input and output, and **UNDEFINED** if there is no connection.

---

**IBM Extension**

---

**ASYNCH=** *char\_variable*

indicates whether the unit is connected for asynchronous access.

*char\_variable* is a character variable that returns the value:

- **YES** if the unit is connected for both synchronous and asynchronous access;
- **NO** if the unit is connected for synchronous access only; or
- **UNDEFINED** if the unit is not connected.

---

**End of IBM Extension**

---

---

**Fortran 2003**

---

**ASYNCHRONOUS=** *char\_var*

indicates whether the file is connected and asynchronous I/O on the unit is allowed.

*char\_var* is a character variable that is assigned the value:

- **YES** if the file is connected and asynchronous I/O on the unit is allowed;
- **NO** if the file is connected and asynchronous I/O on the unit is not allowed; or
- **UNDEFINED** if the file is not connected.

---

**End of Fortran 2003**

---

An **IBM** **ASYNCH=** **IBM** specifier and an **F2003** **ASYNCHRONOUS=** specifier **F2003** should not appear on the same **INQUIRE** statement, the second one is ignored.

**BLANK=** *char\_var*

indicates the default treatment of blanks for a file connected for formatted

input/output. *char\_var* is a scalar character variable that is assigned the value **NULL** if all blanks in numeric input fields are ignored, or the value **ZERO** if all nonleading blanks are interpreted as zeros. If there is no connection, or if the connection is not for formatted input/output, *char\_var* is assigned the value **UNDEFINED**.

---

**Fortran 2003**

---

**DECIMAL=** *char\_var*

*char\_var* is a scalar character variable which is assigned a value of either **POINT**, or **COMMA**, corresponding to the decimal edit mode in effect for a formatted input/output connection. If there is no connection, or if the connection is not for formatted input/output, *char\_var* is assigned the value **UNDEFINED**.

---

**End of Fortran 2003**

---

**DELIM=** *del*

indicates the form, if any, that is used to delimit character data that is written by list-directed or namelist formatting. *del* is a scalar character variable that is assigned the value **APOSTROPHE** if apostrophes are used to delimit data, **QUOTE** if quotation marks are used to delimit data, **NONE** if neither apostrophes nor quotation marks are used to delimit data, and **UNDEFINED** if there is no file connection or no connection to formatted data.

**DIRECT=** *dir*

indicates if the file is connected for direct access. *dir* is a scalar character variable that is assigned the value **YES** if the file can be accessed directly, the value **NO** if the file cannot be accessed directly, or the value **UNKNOWN** if access cannot be determined.

**ERR=** *stmt\_label*

is an error specifier that specifies the statement label of an executable statement in the same scoping unit to which control is to transfer in the case of an error. Coding the **ERR=** specifier suppresses error messages.

**EXIST=** *ex*

indicates if a file or unit exists. *ex* is an integer variable that is assigned the value true or false. For the inquire-by-file form of the statement, the value true is assigned if the file specified by the **FILE=** specifier exists. The value false is assigned if the file does not exist. For the inquire-by-unit form of the statement, the value true is assigned if the unit specified by **UNIT=** exists. The value false is assigned if it is an invalid unit.

**FILE=** *char\_expr*

is a file specifier. It specifies the name of the file about which the inquire-by-file form of the statement is inquiring. *char\_expr* is a scalar character expression whose value, when any trailing blanks are removed, is a valid AIX operating system file name. The named file does not have to exist, nor does it have to be associated with a unit.

---

**IBM Extension**

---

**Note:** A valid AIX operating system file name must have a full path name of total length  $\leq 1023$  characters, with each file name  $\leq 255$

characters long (though the full path name need not be specified).

End of IBM Extension

**FORM=** *char\_var*

indicates whether the file is connected for formatted or unformatted input/output. *char\_var* is a scalar default character variable that is assigned the value **FORMATTED** if the file is connected for formatted input/output. The value assigned is **UNFORMATTED** if the file is connected for unformatted input/output. If there is no connection, *char\_var* is assigned the value **UNDEFINED**.

**FORMATTED=** *fnt*

indicates if the file can be connected for formatted input/output. *fnt* is a scalar character variable that is assigned the value **YES** if the file can be connected for formatted input/output, the value **NO** if the file cannot be connected for formatted input/output, or the value **UNKNOWN** if formatting cannot be determined.

Fortran 2003

**ID=** *scalar\_int\_expr*

is a specifier that identifies a pending data transfer operation for a specified unit. *scalar\_int\_expr* is a scalar default character variable.

If an **ID=** specifier appears and the specified data transfer operation is complete, then the variable specified in the **PENDING=** specifier is assigned the value false and the **INQUIRE** statement performs the wait operation for the specified data transfer.

If there is no **ID=** specifier and all data transfer operations for the specified unit are complete, then the variable specified in the **PENDING=** specifier is assigned the value false and the **INQUIRE** statement performs wait operations for all previously pending data transfers for the specified unit.

**PENDING=** specifier will be assigned the value true in all other cases and no wait operations will be performed. Previously pending data transfers will remain pending after the execution of the **INQUIRE** statement.

End of Fortran 2003

Fortran 2003

**IOMSG=** *iomsg\_variable*

is an input/output status specifier that specifies the message returned by the input/output operation. *iomsg\_variable* is a scalar default character variable. It must not be a use-associated nonpointer protected variable. When the input/output statement containing this specifier finishes execution, *iomsg\_variable* is defined as follows:

- If an error, end-of-file, or end-of-record condition occurs, the variable is assigned an explanatory message as if by assignment.
- If no such condition occurs, the value of the variable is unchanged.

End of Fortran 2003

**IOSTAT=** *ios*

is an input/output status specifier that specifies the status of the

input/output operation. *ios* is an integer variable. When the input/output statement containing this specifier is finished executing, *ios* is defined with:

- A zero value if no error condition occurs
- A positive value if an error occurs.

Coding the **IOSTAT=** specifier suppresses error messages.

**NAME=** *fn*

indicates the name of the file. *fn* is a scalar character variable that is assigned the name of the file to which the unit is connected.

**NAMED=** *nmd*

indicates if the file has a name. *nmd* is an integer variable that is assigned the value true if the file has a name. The value assigned is false if the file does not have a name.

**NEXTREC=** *nr*

indicates where the next record can be read or written on a file connected for direct access. *nr* is an integer variable that is assigned the value  $n + 1$ , where  $n$  is the record number of the last record read or written on the file connected for direct access. If the file is connected but no records were read or written since the connection, *nr* is assigned the value 1. If the file is not connected for direct access or if the position of the file cannot be determined because of a previous error, *nr* becomes undefined.

#### IBM Extension

Because record numbers can be greater than  $2^{*}31-1$ , you may choose to make the scalar variable specified with the **NEXTREC=** specifier of type **INTEGER(8)**. This could be accomplished in many ways, two examples include:

- Explicitly declaring *nr* as **INTEGER(8)**
- Changing the default kind of integers with the **-qintsize=8** compiler option.

#### End of IBM Extension

**NUMBER=** *num*

indicates the external unit identifier currently associated with the file. *num* is an integer variable that is assigned the value of the external unit identifier of the unit that is currently connected to the file. If there is no unit connected to the file, *num* is assigned the value -1.

**OPENED=** *od*

indicates if a file or unit is connected. *od* is an integer variable that is assigned the value true or false. For the inquire-by-file form of the statement, the value true is assigned if the file specified by **FILE=** *char\_var* is connected to a unit. The value false is assigned if the file is not connected to a unit. For the inquire-by-unit form of the statement, the value true is assigned if the unit specified by **UNIT=** is connected to a file. The value false is assigned if the unit is not connected to a file. For preconnected files that have not been closed, the value is true both before and after the first input/output operation.

**PAD=** *pd*

indicates the current **PAD** mode of the connection. *pd* is a scalar character

variable with the default value **YES**. *pd* is assigned the value **NO** if the connection of the file specifies **PAD=NO**.

**Fortran 95**

**PAD=** returns **UNDEFINED** when there is no connection, or when the connection is for unformatted I/O. If you compile your application with **-qxlf90=oldpad**, **PAD=** returns **YES** in these cases.

**End of Fortran 95**

**Fortran 2003**

**PENDING=***scalar\_default\_logical\_variable*

indicates whether or not previously pending asynchronous data transfers are complete. A data transfer operation is previously pending if it is pending at the beginning of execution of the **INQUIRE** statement. *scalar\_default\_logical\_variable* is an integer variable that is assigned the value true or false.

**End of Fortran 2003**

**Fortran 2003**

**POS=***integer\_var*

*integer\_var* is an integer variable that indicates the value of the file position for a file connected for stream access. *integer\_var* is assigned the number of the file storage unit immediately following the current position of a file connected for stream access. If the file is positioned at its terminal position, *integer\_var* is assigned a value one greater than the highest-numbered storage unit in the file. *integer\_var* becomes undefined if the file is not connected for stream access or if the position of the file can not be determined because of previous error conditions.

**End of Fortran 2003**

**POSITION=** *pos*

indicates the position of the file. *pos* is a scalar character variable that is assigned the value **REWIND** if the file is connected by an **OPEN** statement for positioning at its initial point, **APPEND** if the file is connected for positioning before its endfile record or at its terminal point, **ASIS** if the file is connected without changing its position, or **UNDEFINED** if there is no connection or if the file is connected for direct access.

If the file has been repositioned to its initial point since it was opened, *pos* is assigned the value **REWIND**. If the file has been repositioned just before its endfile record since it was opened (or, if there is no endfile record, at its terminal point), *pos* is assigned the value **APPEND**. If both of the above are true and the file is empty, *pos* is assigned the value **APPEND**. If the file is positioned after the endfile record, *pos* is assigned the value **ASIS**.

**READ=** *rd*

indicates if the file can be read. *rd* is a scalar character variable that is assigned the value **YES** if the file can be read, **NO** if the file cannot be read, and **UNKNOWN** if it cannot be determined if the file can be read.

**READWRITE=** *rw*

indicates if the file can be both read from and written to. *rw* is a scalar character variable that is assigned the value **YES** if the file can be both read from and written to, **NO** if the file cannot be both read from and written to, and **UNKNOWN** if it cannot be determined if the file can be both read from and written to.

**RECL=** *rcl*

indicates the value of the record length of a file connected for direct access, or the value of the maximum record length of a file connected for sequential access.

*rcl* is an integer variable that is assigned the value of the record length.

If the file is connected for formatted input/output, the length is the number of characters for all records that contain character data. If the file is connected for unformatted input/output, the length is the number of bytes of data. If there is no connection, *rcl* becomes undefined.

**F2003** If the file is connected for stream access, *rcl* becomes undefined.  
**F2003**

---

**Fortran 2003**

---

**ROUND=** *char\_var*

assigns the value **UP**, **DOWN**, **ZERO**, **PROCESSOR\_DEPENDENT**, **NEAREST** or **COMPATIBLE**, (whichever is the rounding mode for the current connection) to *char\_var*. If there is no connection or the input is not formatted, the returned value is **UNDEFINED**. *char\_var* is a character variable.

The rounding mode helps specify how decimal numbers are converted to an internal representation, (that is, in binary) from a character representation and vice versa during formatted input and output. The rounding modes have the following functions:

- In the **UP** rounding mode the value from the conversion is the smallest value that is greater than or equal to the original value.
- In the **DOWN** rounding mode the value from the conversion is the greatest value that is smaller than or equal to the original value.
- In the **ZERO** rounding mode the value from the conversion is the closest value to the original value, and not greater in magnitude.
- In the **NEAREST** rounding mode the value from the conversion is the closer of the two nearest representable values. If both values are equally close then the even value will be chosen. In IEEE rounding conversions, **NEAREST** corresponds to the `ieee_nearest` rounding mode as specified by the IEEE standard.
- In the **COMPATIBLE** rounding mode the value from the conversion is the closest of the two nearest representable values, or the value further away from zero if halfway between.
- In the **PROCESSOR\_DEFINED** rounding mode the value from the conversion is processor dependent and may correspond to the other modes. In XL Fortran, the **PROCESSOR\_DEFINED** rounding mode will be the rounding mode you choose in the floating-point control register. If you do not set the floating-point control register explicitly, the default rounding mode is **NEAREST**.



---

**End of Fortran 2003**

---

**SEQUENTIAL=** *seq*

indicates if the file is connected for sequential access. *seq* is a scalar character variable that is assigned the value **YES** if the file can be accessed sequentially, the value **NO** if the file cannot be accessed sequentially, or the value **UNKNOWN** if access cannot be determined.

---

**Fortran 2003**

---

**SIGN=** *char\_var*

indicates the sign mode in effect for a connection for formatted input/output. If *char\_var* is assigned the value **PLUS**, the processor shall produce a plus sign in any position that normally contains an optional plus sign and suppresses plus signs in these positions if *char\_var* is assigned the value **SUPPRESS**. *char\_var* can also be assigned the value **PROCESSOR\_DEFINED** which is the default sign mode and acts the same as **SUPPRESS**. If there is no connection, or if the connection is not for formatted input/output, *char\_var* is assigned the value **UNDEFINED**.

---

**End of Fortran 2003**

---

**SIZE=***filesize*

*filesize* is an integer variable that is assigned the file size in bytes.

---

**Fortran 2003**

---

**STREAM=***strm*

is a scalar default character variable that indicates whether the file is connected for stream access. *strm* is assigned the value **YES** if the file can be accessed using stream access, the value **NO** if the file cannot be accessed using stream access, or the value **UNKNOWN** if access cannot be determined.

---

**End of Fortran 2003**

---

---

**IBM Extension**

---

**TRANSFER=** *char\_variable*

is an asynchronous I/O specifier that indicates whether synchronous and/or asynchronous data transfer are permissible transfer methods for the file.

*char\_variable* is a scalar character variable. If *char\_variable* is assigned the value **BOTH**, then both synchronous and asynchronous data transfer are permitted. If *char\_variable* is assigned the value **SYNCH**, then only synchronous data transfer is permitted. If *char\_variable* is assigned the value **UNKNOWN**, then the processor is unable to determine the permissible transfer methods for this file.

---

**End of IBM Extension**

---

**UNFORMATTED=** *unf*

indicates if the file can be connected for unformatted input/output. *unf* is a scalar character variable that is assigned the value **YES** if the file can be

connected for unformatted input/output, the value **NO** if the file cannot be connected for unformatted input/output, or the value **UNKNOWN** if formatting cannot be determined.

**WRITE=** *wrt*

indicates if the file can be written to. *wrt* is a scalar character variable that is assigned the value **YES** if the file can be written to, **NO** if the file cannot be written to, and **UNKNOWN** if it cannot be determined if the file can be written to.

## Rules

An **INQUIRE** statement can be executed before, while, or after a file is associated with a unit. Any values assigned as the result of an **INQUIRE** statement are values that are current at the time the statement is executed.

### IBM Extension

If the unit or file is connected, the values returned for the **ACCESS=**, **SEQUENTIAL=**, **STREAM=**, **DIRECT=**, **ACTION=**, **READ=**, **WRITE=**, **READWRITE=**, **FORM=**, **FORMATTED=**, **UNFORMATTED=**, **BLANK=**, **DELIM=**, **PAD=**, **RECL=**, **POSITION=**, **NEXTREC=**, **NUMBER=**, **NAME=**, **NAMED=**, **DECIMAL=**, **ROUND=** and **SIGN=** specifiers are properties of the connection, and not of that file. Note that the **EXIST=** and **OPENED=** specifiers return true in these situations.

If a unit or file is not connected or does not exist, the **ACCESS=**, **ACTION=**, **FORM=**, **BLANK=**, **DELIM=**, **POSITION=** specifiers return the value **UNDEFINED**, the **DIRECT=**, **SEQUENTIAL=**, **STREAM=**, **FORMATTED=**, **UNFORMATTED=**, **READ=**, **WRITE=** and **READWRITE=** specifiers return the value **UNKNOWN**, the **RECL=** and **NEXTREC=** specifier variables are not defined, the **PAD=** specifier returns the value **YES**, and the **OPENED** specifier returns the value false. The value returned by the **SIZE=** specifier is -1.

If a unit or file does not exist, the **EXIST=** and **NAMED=** specifiers return the value false, the **NUMBER=** specifier returns the value -1, and the **NAME=** specifier variable is not defined.

If a unit or file exists but is not connected, the **EXIST=** specifier returns the value true. For the inquire-by-unit form of the statement, the **NAMED=** specifier returns the value false, the **NUMBER=** specifier returns the unit number, and the **NAME=** specifier variable is undefined. For the inquire-by-file form of the statement, the **NAMED=** specifier returns the value true, the **NUMBER=** specifier returns -1, and the **NAME=** specifier returns the file name.

### End of IBM Extension

The same variable name must not be specified for more than one specifier in the same **INQUIRE** statement, and must not be associated with any other variable in the list of specifiers.

## Examples

```
SUBROUTINE SUB(N)
  CHARACTER(N) A(5)
  INQUIRE (IOLENGTH=IOL) A(1) ! Inquire by output list
  OPEN (7,RECL=IOL)
```

⋮  
END SUBROUTINE

## Related information

- “Conditions and IOSTAT values” on page 214
- Chapter 9, “XL Fortran Input/Output,” on page 201

---

# INTEGER

## Purpose

An **INTEGER** type declaration statement specifies the length and attributes of objects and functions of type integer. Initial values can be assigned to objects.

## Syntax

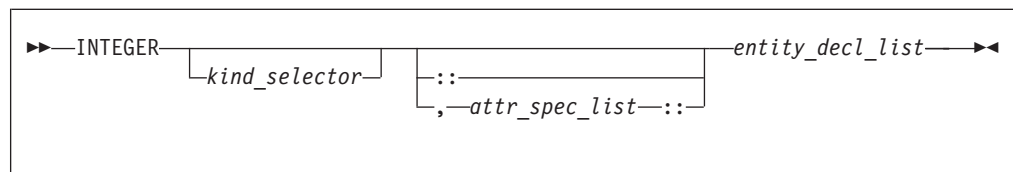

where:

<i>attr_spec</i>
<b>ALLOCATABLE</b>
<b>ASYNCHRONOUS</b>
<b>AUTOMATIC</b>
<b>BIND</b>
<b>DIMENSION</b> ( <i>array_spec</i> )
<b>EXTERNAL</b>
<b>INTENT</b> ( <i>intent_spec</i> )
<b>INTRINSIC</b>
<b>OPTIONAL</b>
<b>PARAMETER</b>
<b>POINTER</b>
<b>PRIVATE</b>
<b>PROTECTED</b>
<b>PUBLIC</b>
<b>SAVE</b>
<b>STATIC</b>
<b>TARGET</b>
<b>VALUE</b>
<b>VOLATILE</b>

*kind\_selector*

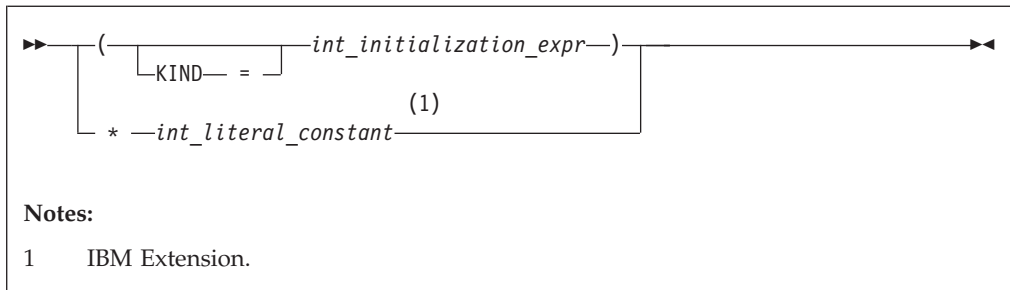

**IBM Extension**

specifies the length of integer entities: 1, 2, 4 or 8. *int\_literal\_constant* cannot specify a kind type parameter.

**End of IBM Extension**

*attr\_spec*

For detailed information on rules about a particular attribute, refer to the statement of the same name.

*intent\_spec*

is either **IN**, **OUT**, or **INOUT**

:: is the double colon separator. Use the double colon separator when you specify attributes, =*initialization\_expr*, **F95** or => **NULL0** **F95**.

*array\_spec*

is a list of dimension bounds

*entity\_decl*

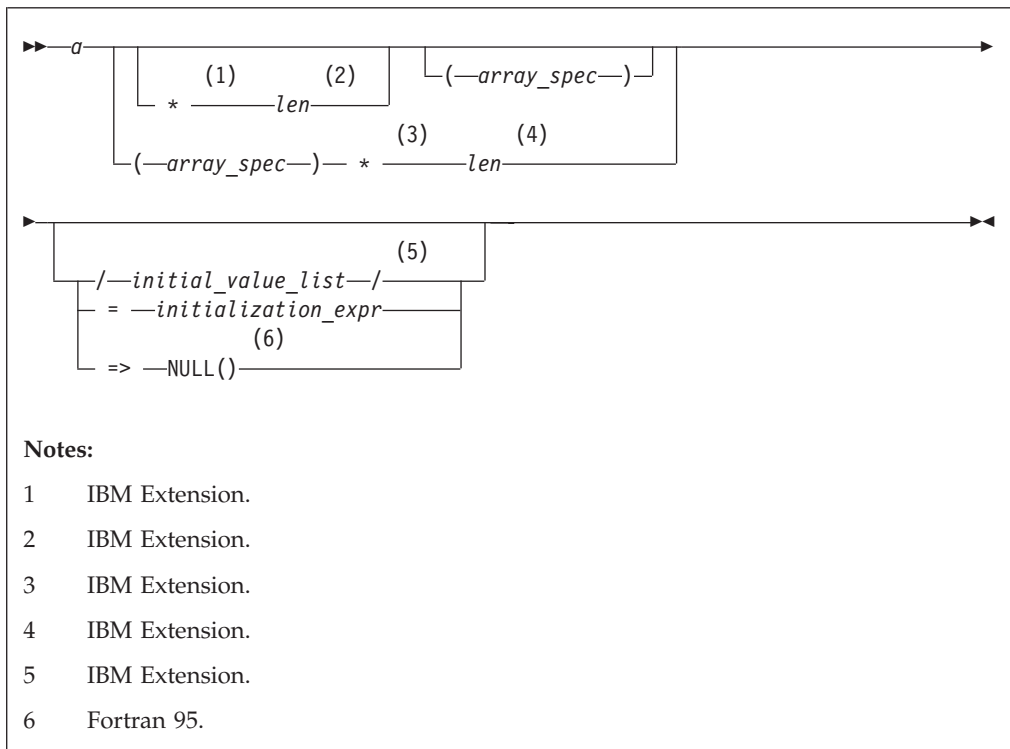

*a* is an object name or function name. *array\_spec* cannot be specified for a function name with an implicit interface.

IBM Extension

*len* overrides the length as specified in *kind\_selector*, and cannot specify a kind type parameter. The entity length must be an integer literal constant that represents one of the permissible length specifications.

End of IBM Extension

IBM Extension

*initial\_value* provides an initial value for the entity specified by the immediately preceding name

End of IBM Extension

*initialization\_expr* provides an initial value, by means of an initialization expression, for the entity specified by the immediately preceding name

Fortran 95

=> NULL() provides the initial value for the pointer object

End of Fortran 95

## Rules

Fortran 95

Within the context of a derived type definition:

- If => appears in a component initialization, the **POINTER** attribute must appear in the *attr\_spec\_list*.
- If = appears in a component initialization, the **POINTER** attribute cannot appear in the component *attr\_spec\_list*.
- The compiler will evaluate *initialization\_expr* within the scoping unit of the type definition.

If => appears for a variable, the object must have the **POINTER** attribute.

End of Fortran 95

If *initialization\_expr* appears for a variable, the object cannot have the **POINTER** attribute.

Entities in type declaration statements are constrained by the rules of any attributes specified for the entities, as detailed in the corresponding attribute statements.

The type declaration statement overrides the implicit type rules in effect. You can use a type declaration statement that confirms the type of an intrinsic function. The appearance of a generic or specific intrinsic function name in a type declaration statement does not cause the name to lose its intrinsic property.

An object cannot be initialized in a type declaration statement if it is a dummy argument, an allocatable object, a pointer, a function result, an object in blank common, an integer pointer, an external name, an intrinsic name, or an automatic object. Nor can an object be initialized if it has the **AUTOMATIC** attribute. The object may be initialized if it appears in a named common block in a block data program unit  or if it appears in a named common block in a module.





Fortran 95

You can initialize pointers using `=> NULL()`.

End of Fortran 95

The specification expression of an *array\_spec* can be a nonconstant expression if the specification expression appears in an interface body or in the specification part of a subprogram. Any object being declared that uses this nonconstant expression and is not a dummy argument or a pointee is called an *automatic object*.

An attribute cannot be repeated in a given type declaration statement, nor can an entity be explicitly given the same attribute more than once in a scoping unit.

*initialization\_expr* must be specified if the statement contains the **PARAMETER** attribute. If the entity you are declaring is a variable, and *initialization\_expr*  or `NULL()`  is specified, the variable is initially defined.



Fortran 95

If the entity you are declaring is a derived type component, and *initialization\_expr* or `NULL()` is specified, the derived type has default initialization.

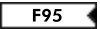
End of Fortran 95

*a* becomes defined with the value determined by *initialization\_expr*, in accordance with the rules for intrinsic assignment. If the entity is an array, its shape must be specified either in the type declaration statement or in a previous specification statement in the same scoping unit. A variable or variable subobject cannot be initialized more than once. If *a* is a variable, the presence of *initialization\_expr*  or `NULL()`  implies that *a* is a saved object, except for an object in a named common block. The initialization of an object could affect the fundamental storage class of an object.

An *array\_spec* specified in the *entity\_decl* takes precedence over the *array\_spec* in the **DIMENSION** attribute.

An array function result that does not have the  **ALLOCATABLE** or  **POINTER** attribute must have an explicit-shape array specification.

If the entity declared is a function, it must not have an accessible explicit interface unless it is an intrinsic function.

### IBM Extension

If T or F, defined previously as the name of a constant, appears in a type declaration statement, it is no longer an abbreviated logical constant but the name of the named constant.

### End of IBM Extension

## Examples

```
MODULE INT
  INTEGER, DIMENSION(3) :: A,B,C
  INTEGER :: X=234,Y=678
END MODULE INT
```

## Related information

- “Integer” on page 35
- “Initialization expressions” on page 95
- “Determining Type” on page 17, for details on the implicit typing rules
- “Array declarators” on page 73
- “Automatic objects” on page 18
- “Storage classes for variables” on page 26
- “DATA” on page 314, for details on initial values

---

## INTENT

### Purpose

The **INTENT** attribute specifies the intended use of dummy arguments.

### Syntax

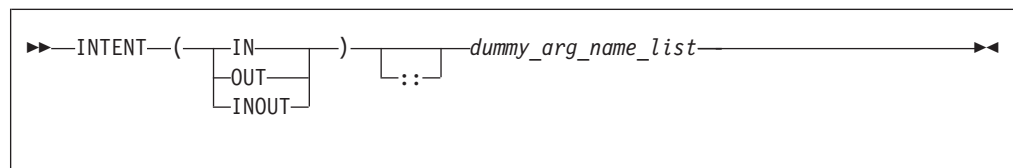

*dummy\_arg\_name*

is the name of a dummy argument, which cannot be a dummy procedure

### Rules

If you specify a nonpointer, nonallocatable dummy argument, the **INTENT** attribute will have the following characteristics:

- **INTENT(IN)** specifies that the dummy argument must not be redefined or become undefined during the execution of the subprogram.
- **INTENT(OUT)** specifies that the dummy argument must be defined before it is referenced within the subprogram. Such a dummy argument might not become undefined on invocation of the subprogram.
- **INTENT(INOUT)** specifies that the dummy argument can both receive and return data to the invoking subprogram.

If you specify a pointer dummy argument, the **INTENT** attribute will have the following characteristics:

- **INTENT(IN)** specifies that during the execution of the procedure, the association status of the pointer dummy argument cannot be changed, except if the target of the pointer is deallocated. If the target of the pointer is deallocated, the association status of the pointer dummy argument becomes undefined.

You cannot use an **INTENT(IN)** pointer dummy argument as a pointer object in a pointer assignment statement. You cannot allocate, deallocate, or nullify an **INTENT(IN)** pointer dummy argument

You cannot specify an **INTENT(IN)** pointer dummy argument as an actual argument to a procedure if the associated dummy argument is a pointer with **INTENT(OUT)** or **INTENT(INOUT)** attribute.

- **INTENT(OUT)** specifies that at the execution of the procedure, the association status of the pointer dummy argument is undefined
- **INTENT(INOUT)** specifies that the dummy argument can both receive and return data to the invoking subprogram.

If you specify an allocatable dummy argument, the **INTENT** attribute will have the following characteristics:

- **INTENT(IN)** specifies that during the execution of the procedure, the allocation status of the dummy argument cannot be changed, and it must not be redefined or become undefined.
- **INTENT(OUT)** specifies that at the execution of the procedure, if the associated actual argument is currently allocated it will be deallocated.
- **INTENT(INOUT)** specifies that the dummy argument can both receive and return data to the invoking subprogram.

If you do not specify the **INTENT** attribute for a pointer or allocatable dummy argument, its use is subject to the limitations and restrictions of the associated actual argument.

An actual argument that becomes associated with a dummy argument with an intent of **OUT** or **INOUT** must be definable. Hence, a dummy argument with an intent of **IN**, or an actual argument that is a constant, a subobject of a constant, or an expression, cannot be passed as an actual argument to a subprogram expecting an argument with an intent of **OUT** or **INOUT**.

An actual argument that is an array section with a vector subscript cannot be associated with a dummy array that is defined or redefined (that is, with an intent of **OUT** or **INOUT**).

#### Attributes compatible with the **INTENT** attribute

- |                |                     |
|----------------|---------------------|
| • ALLOCATABLE  | • POINTER           |
| • ASYNCHRONOUS | • TARGET            |
| • DIMENSION    | • VALUE             |
| • OPTIONAL     | • VOLATILE <b>1</b> |

#### Notes:

1. IBM Extension  
Specifying **VOLATILE** with **INTENT(IN)** is an IBM Extension.



You must not specify the **VALUE** attribute for a dummy argument with an intent of **OUT** or **INOUT**

**IBM Extension**

The **%VAL** built-in function, used for interlanguage calls, can only be used for an actual argument that corresponds to a dummy argument with an intent of **IN**, or has no intent specified. This constraint does not apply to the **%REF** built-in function.

**End of IBM Extension**

## Examples

```
PROGRAM MAIN
  DATA R,S /12.34,56.78/
  CALL SUB(R+S,R,S)
END PROGRAM

SUBROUTINE SUB (A,B,C)
  INTENT(IN) A
  INTENT(OUT) B
  INTENT(INOUT) C
  C=C+A+ABS(A)           ! Valid references to A and C
                        ! Valid redefinition of C
  B=C**2                 ! Valid redefinition of B
END SUBROUTINE
```

## Related information

- “Intent of dummy arguments” on page 185
- “Argument association” on page 183
- “%VAL and %REF” on page 184, for details on interlanguage calls
- “Dummy arguments” on page 182

## INTERFACE

### Purpose

The **INTERFACE** statement is the first statement of an interface block, which can specify an explicit interface for an external or dummy procedure.

### Syntax

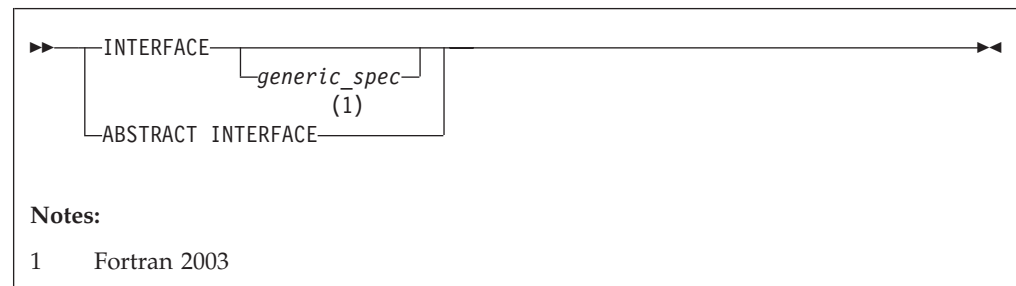

*generic\_spec*  
is

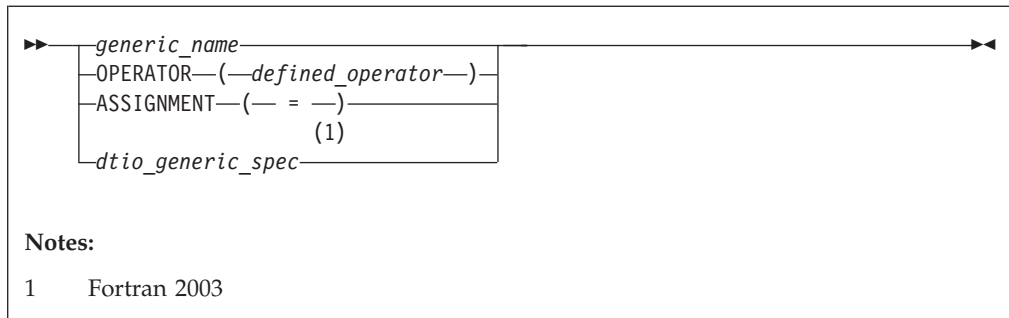

*defined\_operator*  
 is a defined unary operator, defined binary operator, or extended intrinsic operator

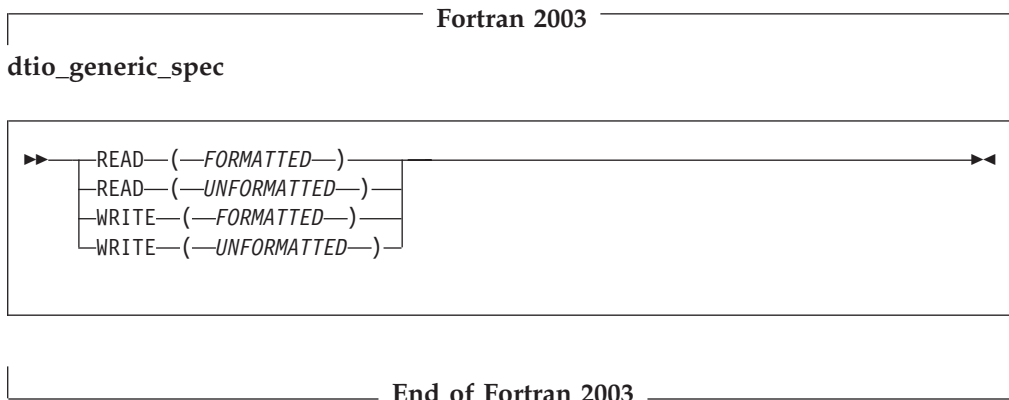

## Rules

If *generic\_spec* is present, the interface block is generic. If *generic\_spec* and **ABSTRACT** is absent, the interface block is specific. An interface block introduced by **ABSTRACT INTERFACE** is an abstract interface block. *generic\_name* specifies a single name to reference all procedures in the interface block. At most, one specific procedure is invoked each time there is a procedure reference with a generic name.

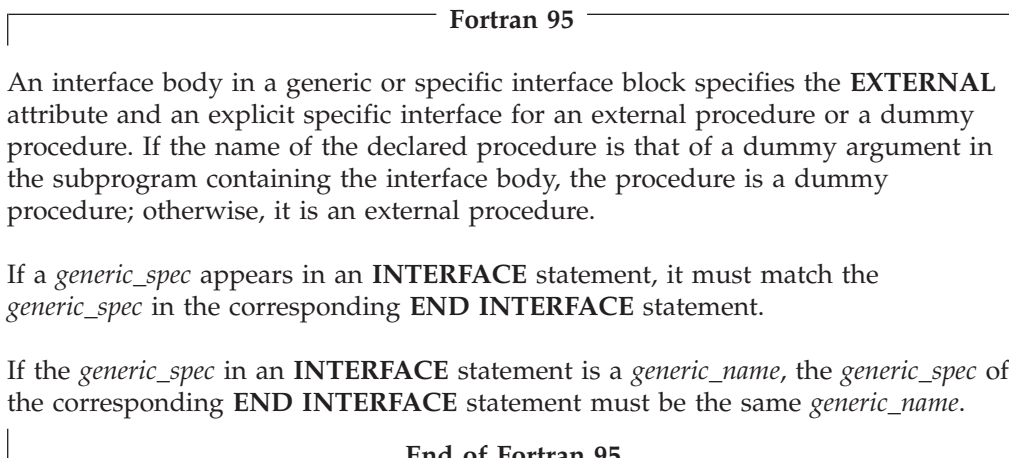

An **INTERFACE** statement without a *generic\_spec* can match any **END INTERFACE** statement, with or without a *generic\_spec*.

A specific procedure must not have more than one explicit interface in a given scoping unit.

You can always reference a procedure through its specific interface, if accessible. If a generic interface exists for a procedure, the procedure can also be referenced through the generic interface.

If *generic\_spec* is **OPERATOR**(*defined\_operator*), the interface block can define a defined operator or extend an intrinsic operator.

If *generic\_spec* is **ASSIGNMENT**(=), the interface block can extend intrinsic assignment.

---

**Fortran 2003**

---

If *generic\_spec* is *dtio\_generic\_spec*, the interface block defines derived type input/output procedures. User-defined derived type input/output procedures allow your application to override the default handling of derived type objects and values in data transfer input/output statements. The subroutines in this interface block must have interfaces described in “User-defined derived-type Input/Output procedure interfaces” on page 210.

---

**End of Fortran 2003**

---

## Examples

```
INTERFACE                                ! Nongeneric interface block
  FUNCTION VOL(RDS,HGT)
    REAL VOL, RDS, HGT
  END FUNCTION VOL
  FUNCTION AREA (RDS)
    REAL AREA, RDS
  END FUNCTION AREA
END INTERFACE

INTERFACE OPERATOR (.DETERMINANT.)      ! Defined operator interface
  FUNCTION DETERMINANT(X)
    INTENT(IN) X
    REAL X(50,50), DETERMINANT
  END FUNCTION
END INTERFACE

INTERFACE ASSIGNMENT(=)                 ! Defined assignment interface
  SUBROUTINE BIT_TO_NUMERIC (N,B)
    INTEGER, INTENT(OUT) :: N
    LOGICAL, INTENT(IN)  :: B(:)
  END SUBROUTINE
END INTERFACE
```

## Related information

- “Explicit interface” on page 157
- “Extended intrinsic and defined operations” on page 106
- “Defined operators” on page 163
- “Defined assignment” on page 165
- “User-defined derived-type Input/Output procedure interfaces” on page 210
- “FUNCTION” on page 362
- “SUBROUTINE” on page 453
- “PROCEDURE” on page 418

- “Procedure references” on page 177
- “Unambiguous generic procedure references” on page 161, for details about the rules on how any two procedures with the same generic name must differ

---

## INTRINSIC

### Purpose

The **INTRINSIC** attribute identifies a name as an intrinsic procedure and allows you to use specific names of intrinsic procedures as actual arguments.

### Syntax

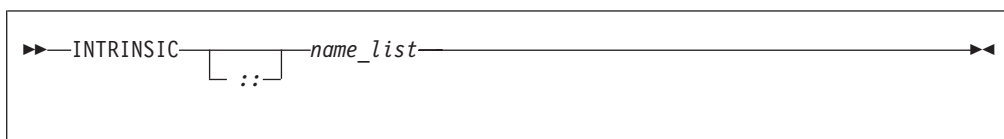

*name* is the name of an intrinsic procedure

### Rules

If you use a specific intrinsic procedure name as an actual argument in a scoping unit, it must have the **INTRINSIC** attribute. Generic names can have the **INTRINSIC** attribute, but you cannot pass them as arguments unless they are also specific names.

A generic or specific procedure that has the **INTRINSIC** attribute keeps its generic or specific properties.

A generic intrinsic procedure that has the **INTRINSIC** attribute can also be the name of a generic interface block. The generic interface block defines extensions to the generic intrinsic procedure.

#### Attributes compatible with the **INTRINSIC** attribute

- PRIVATE
- PUBLIC

### Examples

```

PROGRAM MAIN
  INTRINSIC SIN, ABS
  INTERFACE ABS
    LOGICAL FUNCTION MYABS(ARG)
      LOGICAL ARG
    END FUNCTION
  END INTERFACE

  LOGICAL LANS,LVAR
  REAL(8) DANS,DVAR
  DANS = ABS(DVAR)           ! Calls the DABS intrinsic procedure
  LANS = ABS(LVAR)          ! Calls the MYABS external procedure

  ! Pass intrinsic procedure name to subroutine
  CALL DOIT(0.5,SIN,X)      ! Passes the SIN specific intrinsic
END PROGRAM
  
```

```

SUBROUTINE DOIT(RIN,OPER,RESULT)
  INTRINSIC :: MATMUL
  INTRINSIC   COS
  RESULT = OPER(RIN)
END SUBROUTINE

```

## Related information

- Generic and specific intrinsic procedures are listed in Chapter 14, “Intrinsic procedures,” on page 529. See this section to find out if a specific intrinsic name can be used as an actual argument.
- “Generic interface blocks” on page 161

---

## LOGICAL

### Purpose

A **LOGICAL** type declaration statement specifies the length and attributes of objects and functions of type logical. Initial values can be assigned to objects.

### Syntax

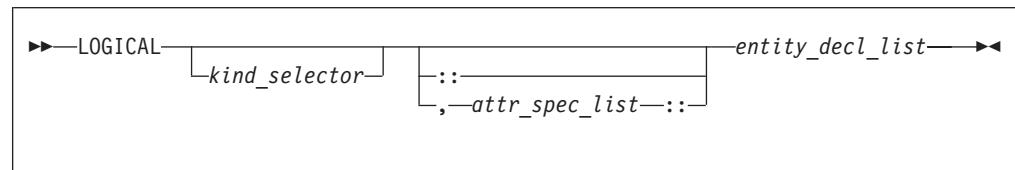

where:

<i>attr_spec</i>
ALLOCATABLE
ASYNCHRONOUS
AUTOMATIC
BIND
DIMENSION ( <i>array_spec</i> )
EXTERNAL
INTENT ( <i>intent_spec</i> )
INTRINSIC
OPTIONAL
PARAMETER
POINTER
PRIVATE
PROTECTED
PUBLIC
SAVE
STATIC
TARGET
VALUE
VOLATILE

*kind\_selector*

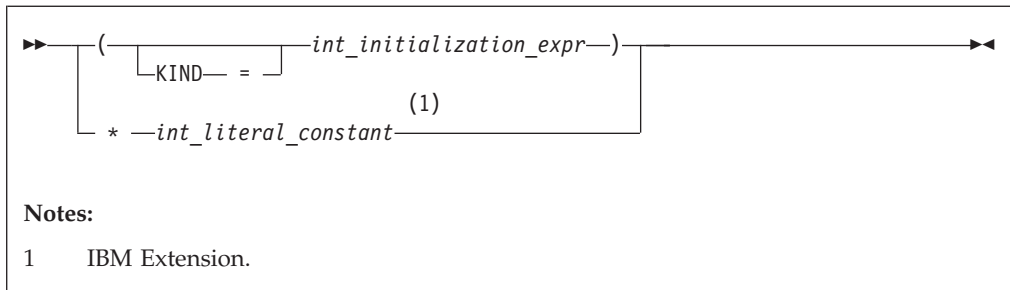

**IBM Extension**

Specifies the length of logical entities: 1, 2, 4 or 8. *int\_literal\_constant* cannot specify a kind type parameter.

**End of IBM Extension**

*attr\_spec*

For detailed information on rules about a particular attribute, refer to the statement of the same name.

*intent\_spec*

is either **IN**, **OUT**, or **INOUT**

:: is the double colon separator. Use the double colon separator when you specify attributes, =*initialization\_expr*, **F95** or => **NULL0** **F95**.

*array\_spec*

is a list of dimension bounds

*entity\_decl*

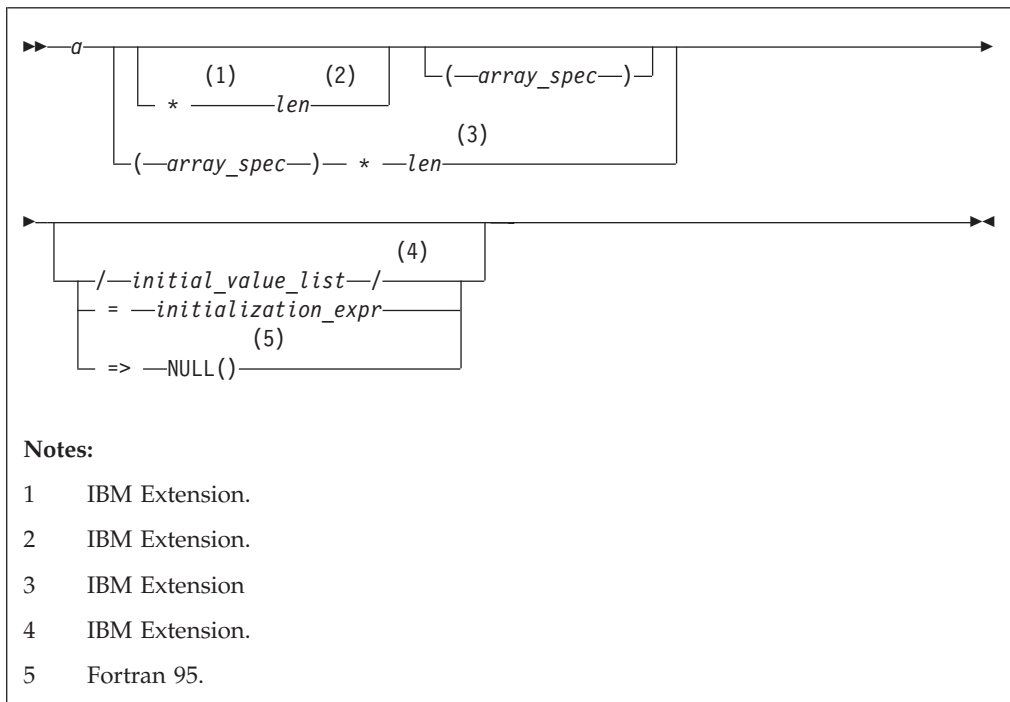

*a* is an object name or function name. *array\_spec* cannot be specified

for a function with an implicit interface.

IBM Extension

*len* overrides the length as specified in *kind\_selector*, and cannot specify a kind type parameter. The entity length must be an integer literal constant that represents one of the permissible length specifications.

End of IBM Extension

IBM Extension

*initial\_value* provides an initial value for the entity specified by the immediately preceding name

End of IBM Extension

*initialization\_expr* provides an initial value, by means of an initialization expression, for the entity specified by the immediately preceding name

Fortran 95

=> **NULL()**  
provides the initial value for the pointer object

End of Fortran 95

## Rules

Fortran 95

Within the context of a derived type definition:

- If => appears in a component initialization, the **POINTER** attribute must appear in the *attr\_spec\_list*.
- If = appears in a component initialization, the **POINTER** attribute cannot appear in the component *attr\_spec\_list*.
- The compiler will evaluate *initialization\_expr* within the scoping unit of the type definition.

If => appears for a variable, the object must have the **POINTER** attribute.

End of Fortran 95

If *initialization\_expr* appears for a variable, the object cannot have the **POINTER** attribute.

Entities in type declaration statements are constrained by the rules of any attributes specified for the entities, as detailed in the corresponding attribute statements.

The type declaration statement overrides the implicit type rules in effect. You can use a type declaration statement that confirms the type of an intrinsic function. The

appearance of a generic or specific intrinsic function name in a type declaration statement does not cause the name to lose its intrinsic property.

An object cannot be initialized in a type declaration statement if it is a dummy argument, an allocatable object, a pointer, a function result, an object in blank common, an integer pointer, an external name, an intrinsic name, or an automatic object. Nor can an object be initialized if it has the **AUTOMATIC** attribute. The object may be initialized if it appears in a named common block in a block data program unit or if it appears in a named common block in a module.

**Fortran 95**

In Fortran 95, a pointer can be initialized. Pointers can only be initialized by the use of `=> NULL()`.

**End of Fortran 95**

The specification expression of an *array\_spec* can be a nonconstant expression if the specification expression appears in an interface body or in the specification part of a subprogram. Any object being declared that uses this nonconstant expression and is not a dummy argument or a pointee is called an *automatic object*.

An attribute cannot be repeated in a given type declaration statement, nor can an entity be explicitly given the same attribute more than once in a scoping unit.

*initialization\_expr* must be specified if the statement contains the **PARAMETER** attribute. If the entity you are declaring is a variable, and *initialization\_expr* **F95** or `NULL()` **F95** is specified, the variable is initially defined.

**Fortran 95**

If the entity you are declaring is a derived type component, and *initialization\_expr* or `NULL()` is specified, the derived type has default initialization.

**End of Fortran 95**

*a* becomes defined with the value determined by *initialization\_expr*, in accordance with the rules for intrinsic assignment. If the entity is an array, its shape must be specified either in the type declaration statement or in a previous specification statement in the same scoping unit. A variable or variable subobject cannot be initialized more than once. If *a* is a variable, the presence of *initialization\_expr* **F95** or `NULL()` **F95** implies that *a* is a saved object, except for an object in a named common block. The initialization of an object could affect the fundamental storage class of an object.

An *array\_spec* specified in the *entity\_decl* takes precedence over the *array\_spec* in the **DIMENSION** attribute.

An array function result that does not have the **F2003** **ALLOCATABLE** or **F2003** **POINTER** attribute must have an explicit-shape array specification.

If the entity declared is a function, it must not have an accessible explicit interface unless it is an intrinsic function.



### IBM Extension

If T or F, defined previously as the name of a constant, appears in a type declaration statement, it is no longer an abbreviated logical constant but the name of the named constant.

End of IBM Extension

## Examples

```
LOGICAL, ALLOCATABLE :: L(:, :)  
LOGICAL :: Z=.TRUE.
```

## Related information

- “Logical” on page 40
- “Initialization expressions” on page 95
- “Determining Type” on page 17, for details on the implicit typing rules
- “Array declarators” on page 73
- “Automatic objects” on page 18
- “Storage classes for variables” on page 26
- “DATA” on page 314, for details on initial values

---

## MODULE

### Purpose

The **MODULE** statement is the first statement of a module program unit, which contains specifications and definitions that can be made accessible to other program units.

### Syntax

```
►►—MODULE—module_name—►►
```

### Rules

The module name is a global entity that is referenced by the **USE** statement in other program units to access the public entities of the module. A user-defined module must not have the same name as any other program unit, external procedure or common block in the program, nor can it be the same as any local name in the module.

If the **END** statement that completes the module specifies a module name, the name must be the same as that specified in the **MODULE** statement.

## Examples

```
MODULE MM  
CONTAINS  
REAL FUNCTION SUM(CARG)  
COMPLEX CARG  
SUM_FNC(CARG) = IMAG(CARG) + REAL(CARG)  
SUM = SUM_FNC(CARG)
```

```

        RETURN
ENTRY AVERAGE(CARG)
    AVERAGE = SUM_FNC(CARG) / 2.0
END FUNCTION SUM
SUBROUTINE SHOW_SUM(SARG)
    COMPLEX SARG
    REAL SUM_TMP
10  FORMAT('SUM:',E10.3,' REAL:',E10.3,' IMAG',E10.3)
    SUM_TMP = SUM(CARG=SARG)
    WRITE(10,10) SUM_TMP, SARG
END SUBROUTINE SHOW_SUM
END MODULE MM

```

## Related information

- “Modules” on page 171
- “USE” on page 468
- “Use association” on page 151
- “END” on page 335, for details on the **END MODULE** statement
- “PRIVATE” on page 416
- **F2003** “PROTECTED” on page 422 **F2003**
- “PUBLIC” on page 424

---

## NAMELIST

### Purpose

The **NAMELIST** statement specifies one or more lists of names for use in **READ**, **WRITE**, and **PRINT** statements.

### Syntax

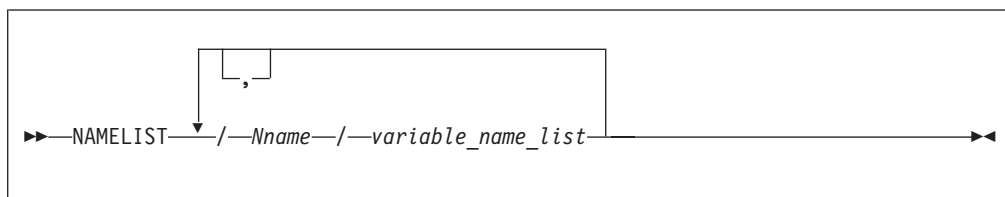

*Nname* is a namelist group name

*variable\_name*

Must not be an assumed-size array, or a pointee. If *variable\_name* is a variable for a type that has an ultimate component that is a pointer, or an allocatable object, it must be processed by a user-defined derived-type I/O procedure.

### Rules

The list of names belonging to a namelist group name ends with the appearance of another namelist group name or the end of the **NAMELIST** statement.

*variable\_name* must either be accessed via use or host association, or have its type and type parameters specified by previous specification statements in the same scoping unit or by the implicit typing rules. If typed implicitly, any appearance of the object in a subsequent type declaration statement must confirm the implied type and type parameters. A derived-type object must not appear as a list item if

any component ultimately contained within the object is not accessible within the scoping unit containing the namelist input/output statement on which its containing namelist group name is specified; unless it is processed by a user-defined derived-type input/output procedure.

*variable\_name* can belong to one or more namelist lists. If the namelist group name has the **PUBLIC** attribute, no item in the list can have the **PRIVATE** attribute or private components.

*Nname* can be specified in more than one **NAMELIST** statement in the scoping unit, and more than once in each **NAMELIST** statement. The *variable\_name\_list* following each successive appearance of the same *Nname* in a scoping unit is treated as the continuation of the list for that *Nname*.

A namelist name can appear only in input/output statements. The rules for input/output conversion of namelist data are the same as the rules for data conversion.

## Examples

```
DIMENSION X(5), Y(10)
NAMELIST /NAME1/ I,J,K
NAMELIST /NAME2/ A,B,C /NAME3/ X,Y
WRITE (10, NAME1)
PRINT NAME2
```

## Related information

- “Namelist formatting” on page 260
- *Setting Run-time Options* in the *XL Fortran Compiler Reference*

---

## NULLIFY

### Purpose

The **NULLIFY** statement causes pointers to become disassociated.

### Syntax

```
▶▶—NULLIFY—(—pointer_object_list—)————▶▶
```

*pointer\_object*

is a pointer variable name or structure component

### Rules

A *pointer\_object* must be definable and have the **POINTER** attribute.

A *pointer\_object* must not depend on the value, bounds, or association status of another *pointer\_object* in the same **NULLIFY** statement.

### Tip

Always initialize a pointer with the **NULLIFY** statement, pointer assignment, **F95** default initialization **F95** or explicit initialization.

## Examples

```
TYPE T
  INTEGER CELL
  TYPE(T), POINTER :: NEXT
ENDTYPE T
TYPE(T) HEAD, TAIL
TARGET :: TAIL
HEAD%NEXT => TAIL
NULLIFY (TAIL%NEXT)
END
```

## Related information

- “Data pointer assignment” on page 123
- “Pointer association” on page 152

---

## OPEN

### Purpose

The **OPEN** statement can be used to connect an existing external file to a unit, create an external file that is preconnected, create an external file and connect it to a unit, or change certain specifiers of a connection between an external file and a unit.

### Syntax

```
▶▶ OPEN (—open_list—) ▶▶
```

*open\_list*

is a list that must contain one unit specifier (**UNIT=*u***) and can also contain one of each of the other valid specifiers. The valid specifiers are:

**[UNIT=]** *u*

is a unit specifier in which *u* must be an external unit identifier whose value is not an asterisk. An external unit identifier refers to an external file that is represented by an integer expression, whose value is in the range 0 through 2,147,483,647. If the optional characters **UNIT=** are omitted, *u* must be the first item in *open\_list*.

**ACCESS=** *char\_expr*

specifies the access method for the connection of the file. *char\_expr* is a scalar character expression whose value, when any trailing blanks are removed, is either **SEQUENTIAL**, **DIRECT** or **STREAM**. If **ACCESS=** is **DIRECT**, **RECL=** must be specified. If **ACCESS=** is **F2003** **STREAM** **F2003**, **RECL=** must not be specified.

**SEQUENTIAL** is the default, for which **RECL=** is optional

**ACTION=** *char\_expr*

specifies the allowed input/output operations. *char\_expr* is a scalar character expression whose value evaluates to **READ**, **WRITE** or **READWRITE**. If **READ** is specified, **WRITE** and **ENDFILE** statements cannot refer to this connection. If **WRITE** is specified, **READ** statements cannot refer to this connection. The value **READWRITE** permits any input/output statement to refer to this connection. If the **ACTION=** specifier is omitted, the default value depends on the actual file permissions:

- If the **STATUS=** specifier has the value **OLD** or **UNKNOWN** and the file already exists:
  - The file is opened with **READWRITE**
  - If the above is not possible, the file is opened with **READ**
  - If neither of the above is possible, the file is opened with **WRITE**.
- If the **STATUS=** specifier has the value **NEW**, **REPLACE**, **SCRATCH** or **UNKNOWN** and the file does not exist:
  - The file is opened with **READWRITE**
  - If the above is not possible, the file is opened with **WRITE**.

---

**IBM Extension**

---

**ASYNCH=** *char\_expr*

is an asynchronous I/O specifier that indicates whether an explicitly connected unit is to be used for asynchronous I/O.

*char\_expr* is a scalar character expression whose value is either **YES** or **NO**. **YES** specifies that asynchronous data transfer statements are permitted for this connection. **NO** specifies that asynchronous data transfer statements are not permitted for this connection. The value specified will be in the set of transfer methods permitted for the file. If this specifier is omitted, the default value is **NO**.

Preconnected units are connected with an **ASYNCH=** value of **NO**.

The **ASYNCH=** value of an implicitly connected unit is determined by the first data transfer statement performed on the unit. If the first statement performs an asynchronous data transfer and the file being implicitly connected permits asynchronous data transfers, the **ASYNCH=** value is **YES**. Otherwise, the **ASYNCH=** value is **NO**.

---

**End of IBM Extension**

---

---

**Fortran 2003**

---

**ASYNCHRONOUS=***char\_expr*

specifies whether or not asynchronous I/O on the unit is allowed.

*char\_expr* is a scalar character expression whose value is either **YES** or **NO**. If *char\_expr* is the value **YES** asynchronous I/O on the unit is allowed. If *char\_expr* is the value **NO** asynchronous I/O on the unit is not allowed. If **ASYNCHRONOUS=** is not present, the default value is **NO**.

---

**End of Fortran 2003**

---

An **IBM** **ASYNCH=** **IBM** specifier and an **F2003** **ASYNCHRONOUS=** specifier **F2003** should not appear on the same **OPEN** statement, the second one is ignored.

**BLANK=** *char\_expr*

controls the default interpretation of blanks when you are using a format specification. *char\_expr* is a scalar character expression whose value, when any trailing blanks are removed, is either **NULL** or **ZERO**. If **BLANK=** is specified, you must use **FORM='FORMATTED'**. If **BLANK=** is not specified and you specify **FORM='FORMATTED'**, **NULL** is the default.

---

**Fortran 2003**

---

**DECIMAL=** *char\_expr*

specifies the default *decimal edit mode* for the corresponding unit. *char\_expr* is a scalar character expression whose value must evaluate to either **POINT** or **COMMA**. If **DECIMAL=** is not specified, the decimal point mode is in effect by default.

---

**End of Fortran 2003**

---

**DELIM=** *char\_expr*

specifies what delimiter, if any, is used to delimit character constants written with list-directed or namelist formatting. *char\_expr* is a scalar character expression whose value must evaluate to **APOSTROPHE**, **QUOTE**, or **NONE**. If the value is **APOSTROPHE**, apostrophes delimit character constants and all apostrophes within character constants are doubled. If the value is **QUOTE**, double quotation marks delimit character constants and all double quotation marks within character constants are doubled. If the value is **NONE**, character constants are not delimited and no characters are doubled. The default value is **NONE**. The **DELIM=** specifier is permitted only for files being connected for formatted input/output, although it is ignored during input of a formatted record.

**ERR=** *stmt\_label*

is an error specifier that specifies the statement label of an executable statement in the same scoping unit to which control is to transfer in the case of an error. Coding the **ERR=** specifier suppresses error messages.

**FILE=** *char\_expr*

is a file specifier that specifies the name of the file to be connected to the specified unit.

---

**IBM Extension**

---

*char\_expr* is a scalar character expression whose value, when any trailing blanks are removed, is a valid AIX operating system file name. If the file specifier is omitted and is required, the unit becomes implicitly connected (by default) to **fort.u**, where *u* is the unit specified with any leading zeros removed. Use the **UNIT\_VARS** run-time option to allow alternative file names to be used for files that are implicitly connected.

**Note:** A valid AIX operating system file name must have a full path name of total length  $\leq 1023$  characters, with each file name  $\leq 255$  characters long (although the full path name need not be specified).

---

**End of IBM Extension**

---

**FORM=** *char\_expr*

specifies the file is connected for unformatted input/output. *char\_expr* is a scalar character expression whose value is **UNFORMATTED**.

Fortran 2003

Asynchronous I/O on a formatted file is permitted. If **FORM=** specifier appears, it can be **FORMATTED** or **UNFORMATTED**

End of Fortran 2003

Fortran 2003

**IOMSG=** *iomsg\_variable*

is an input/output status specifier that specifies the message returned by the input/output operation. *iomsg\_variable* is a scalar default character variable. It must not be a use-associated nonpointer protected variable. When the input/output statement containing this specifier finishes execution, *iomsg\_variable* is defined as follows:

- If an error, end-of-file, or end-of-record condition occurs, the variable is assigned an explanatory message as if by assignment.
- If no such condition occurs, the value of the variable is unchanged.

End of Fortran 2003

**IOSTAT=** *ios*

An input/output status specifier for the status of the input/output operation. *ios* is a scalar integer variable. When the input/output statement containing this specifier finishes execution, *ios* is defined with:

- A zero value if no error condition occurs
- A positive value if an error occurs.

**PAD=** *char\_expr*

specifies if input records are padded with blanks. *char\_expr* is a scalar character expression that must evaluate to **YES** or **NO**. If the value is **YES**, a formatted input record is padded with blanks if an input list is specified and the format specification requires more data from a record than the record contains. If **NO** is specified, the input list and format specification must not require more characters from a record than the record contains. The default value is **YES**. The **PAD=** specifier is permitted only for files being connected for formatted input/output, although it is ignored during output of a formatted record.

IBM Extension

If the **-qxlf77** compiler option specifies the **noblankpad** suboption and the file is being connected for formatted direct input/output, the default value is **NO** when the **PAD=** specifier is omitted.

End of IBM Extension

**POSITION=** *char\_expr*

specifies the file position for a file connected for sequential or stream access. A file that did not exist previously is positioned at its initial point. *char\_expr* is a scalar character expression whose value, when any trailing blanks are removed, is either **ASIS**, **REWIND**, or **APPEND**. **REWIND**

positions the file at its initial point. **APPEND** positions the file before the endfile record or, if there is no endfile record, at the terminal point. **ASIS** leaves the position unchanged. The default value is **ASIS** except under the following conditions:

- The first input/output statement (other than the **INQUIRE** statement) referring to the unit after the **OPEN** statement is a **WRITE** statement, and either:
  - The **STATUS=** specifier is **UNKNOWN** and the **-qposition** compiler option specifies **appendunknown**, or
  - The **STATUS=** specifier is **OLD** and the **-qposition** compiler option specifies **appendold**.

In such cases, the default value for the **POSITION=** specifier is **APPEND** at the time the **WRITE** statement is executed.

**RECL=** *integer\_expr*

specifies the length of each record in a file being connected for direct access or the maximum length of a record in a file being connected for sequential access. *integer\_expr* is an integer expression whose value must be positive. This specifier must be present when a file is being connected for direct access. For formatted input/output, the length is the number of characters for all records that contain character data. For unformatted input/output, the length is the number of bytes required for the internal form of the data. The length of an unformatted sequential record does not count the four-byte fields surrounding the data.

#### IBM Extension

If **RECL=** is omitted when a file is being connected for sequential access in 32-bit, the length is  $2^{31}-1$ , minus the record terminator. For a formatted sequential file in 32-bit, the default record length is  $2^{31}-2$ . For an unformatted file that can be accessed in 32-bit, the default record length is  $2^{31}-9$ .

For a file that cannot be accessed randomly in 32-bit, the default length is  $2^{15}$  (32,768).

If **RECL=** is omitted when a file is being connected for sequential access in 64-bit, the length is  $2^{63}-1$ , minus the record terminator. For a formatted sequential file in 64-bit, the default record length is  $2^{63}-2$ . For an unformatted file in 64-bit, the default record length is  $2^{63}-17$  when the **UWIDTH** run-time option is set to 64.

#### End of IBM Extension

#### Fortran 2003

**ROUND=** *char\_expr*

states the current value of the I/O rounding mode for formatted input and output. The **ROUND=** can be changed by other statements. If omitted, then the processor can choose the rounding mode. *char\_expr* evaluates to either **UP**, **DOWN**, **ZERO**, **NEAREST**, **COMPATIBLE** or **PROCESSOR\_DEFINED**

The rounding mode helps specify how decimal numbers are converted to an internal representation, (that is, in binary) from a character



representation and vice versa during formatted input and output. The rounding modes have the following functions:

- In the **UP** rounding mode the value from the conversion is the smallest value that is greater than or equal to the original value.
- In the **DOWN** rounding mode the value from the conversion is the greatest value that is smaller than or equal to the original value.
- In the **ZERO** rounding mode the value from the conversion is the closest value to the original value, and not greater in magnitude.
- In the **NEAREST** rounding mode the value from the conversion is the closer of the two nearest representable values. If both values are equally close then the even value will be chosen. In IEEE rounding conversions, NEAREST corresponds to the `ieee_nearest` rounding mode as specified by the IEEE standard.
- In the **COMPATIBLE** rounding mode the value from the conversion is the closest of the two nearest representable values, or the value further away from zero if halfway between.
- In the **PROCESSOR\_DEFINED** rounding mode the value from the conversion is processor dependent and may correspond to the other modes. In the **PROCESSOR\_DEFINED** rounding mode the value from the conversion is processor dependent and may correspond to the other modes. In XL Fortran, the **PROCESSOR\_DEFINED** rounding mode will be the rounding mode you choose in the floating-point control register. If you do not set the floating-point control register explicitly, the default rounding mode is **NEAREST**.

End of Fortran 2003

Fortran 2003

**SIGN=** *char\_expr*

indicates the sign mode in effect for a connection for formatted input/output. If *char\_expr* is assigned the value **PLUS**, the processor shall produce a plus sign in any position that normally contains an optional plus sign and suppresses plus signs in these positions if *char\_expr* is assigned the value **SUPPRESS**. *char\_expr* can also be assigned the value **PROCESSOR\_DEFINED** which is the default sign mode and acts the same as **SUPPRESS**. If there is no connection, or if the connection is not for formatted input/output, *char\_expr* is assigned the value **UNDEFINED**. The sign mode may be temporarily changed in a single data transfer statement. When the statement terminates, the sign mode resumes its previous value.

End of Fortran 2003

**STATUS=** *char\_expr*

specifies the status of the file when it is opened. *char\_expr* is a scalar character expression whose value, when any trailing blanks are removed, is one of the following:

- **OLD**, to connect an existing file to a unit. If **OLD** is specified, the file must exist. If the file does not exist, an error condition will occur.
- **NEW**, to create a new file, connect it to a unit, and change the status to **OLD**. If **NEW** is specified, the file must not exist. If the file already exists, an error condition will occur.

- **SCRATCH**, to create and connect a new file that will be deleted when it is disconnected. **SCRATCH** must not be specified with a named file (that is, **FILE=char\_expr** must be omitted).
- **REPLACE**. If the file does not already exist, the file is created and the status is changed to **OLD**. If the file exists, the file is deleted, a new file is created with the same name, and the status is changed to **OLD**.
- **UNKNOWN**, to connect an existing file, or to create and connect a new file. If the file exists, it is connected as **OLD**. If the file does not exist, it is connected as **NEW**.

**UNKNOWN** is the default.

## Rules

If a unit is connected to a file that exists, an **OPEN** statement for that unit can be performed. If the **FILE=** specifier is not included in the **OPEN** statement, the file to be connected to the unit is the same as the file to which the unit is connected.

If the file to be connected to the unit is not the same as the file to which the unit is connected, the effect is as if a **CLOSE** statement without a **STATUS=** specifier had been executed for the unit immediately prior to the execution of the **OPEN** statement.

If the file to be connected to the unit is the same as the file to which the unit is connected, only the **BLANK=**, **DELIM=**, **PAD=**, **ERR=**, and **IOSTAT=** specifiers can have a value different from the one currently in effect. Execution of the **OPEN** statement causes any new value for the **BLANK=**, **DELIM=** or **PAD=** specifiers to be in effect, but does not cause any change in any of the unspecified specifiers or the position of the file. Any **ERR=** and **IOSTAT=** specifiers from **OPEN** statements previously executed have no effect on the current **OPEN** statement. If you specify the **STATUS=** specifier it must have the value **OLD**. To specify the same file as the one currently connected to the unit, you can specify the same file name, omit the **FILE=** specifier, or specify a file symbolically linked to the same file.

If a file is connected to a unit, an **OPEN** statement on that file and a different unit cannot be performed.

### IBM Extension

If the **STATUS=** specifier has the value **OLD**, **NEW** or **REPLACE**, the **FILE=** specifier is optional.

Unit 0 cannot be specified to connect to a file other than the preconnected file, the standard error device, although you can change the values for the **BLANK=**, **DELIM=** and **PAD=** specifiers.

### End of IBM Extension

If the **ERR=** and **IOSTAT=** specifiers are set and an error is encountered, transfer is made to the statement specified by the **ERR=** specifier and a positive integer value is assigned to *ios*.

### IBM Extension

If **IOSTAT=** and **ERR=** are not specified,

- The program stops if a severe error is encountered

- The program continues to the next statement if a recoverable error is encountered and the **ERR\_RECOVERY** run-time option is set to **YES**. If the option is set to **NO**, the program stops.

End of IBM Extension

## Examples

```
! Open a new file with name fname

CHARACTER*20 FNAME
FNAME = 'INPUT.DAT'
OPEN(UNIT=8,FILE=FNAME,STATUS='NEW',FORM='FORMATTED')

OPEN (4,FILE="myfile")
OPEN (4,FILE="myfile", PAD="NO") ! Changing PAD= value to NO

! Connects unit 2 to a tape device for unformatted, sequential
! write-only access:

OPEN (2, FILE="/dev/rmt0",ACTION="WRITE",POSITION="REWIND", &
& FORM="UNFORMATTED",ACCESS="SEQUENTIAL",RECL=32767)
```

## Related information

- “Units” on page 205
- Item 3 under Appendix A, “Compatibility across standards,” on page 815
- Chapter 9, “XL Fortran Input/Output,” on page 201
- *Setting Run-time Options in the XL Fortran Compiler Reference*
- **-qposition** Option in the *XL Fortran Compiler Reference*
- **-qxlf77** Option in the *XL Fortran Compiler Reference*
- “CLOSE” on page 301
- “READ” on page 425
- “WRITE” on page 481

## OPTIONAL

### Purpose

The **OPTIONAL** attribute specifies that a dummy argument need not be associated with an actual argument in a reference to the procedure.

### Syntax

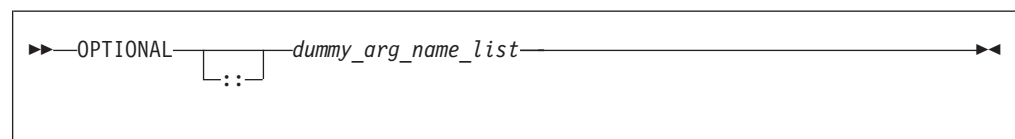

### Rules

A procedure that has an optional dummy argument must have an explicit interface in any scope in which the procedure is referenced.

Use the **PRESENT** intrinsic function to determine if an actual argument has been associated with an optional dummy argument. Avoid referencing an optional dummy argument without first verifying that the dummy argument is present.

A dummy argument is considered present in a subprogram if it is associated with an actual argument, which itself can also be a dummy argument that is present (an instance of propagation). A dummy argument that is not optional must be present; that is, it must be associated with an actual argument.

An optional dummy argument that is not present may be used as an actual argument corresponding to an optional dummy argument, which is then also considered not to be associated with an actual argument. An optional dummy argument that is not present is subject to the restrictions specified in the section: "Restrictions on optional dummy arguments not present" on page 186

The **OPTIONAL** attribute cannot be specified for dummy arguments in an interface body that specifies an explicit interface for a defined operator or defined assignment.

#### Attributes compatible with the **OPTIONAL** attribute

- ALLOCATABLE
- ASYNCHRONOUS
- DIMENSION
- EXTERNAL
- INTENT
- POINTER
- TARGET
- VALUE
- VOLATILE

## Examples

```

SUBROUTINE SUB (X,Y)
  INTERFACE
    SUBROUTINE SUB2 (A,B)
      OPTIONAL :: B
    END SUBROUTINE
  END INTERFACE
  OPTIONAL :: Y
  IF (PRESENT(Y)) THEN           ! Reference to Y conditional
    X = X + Y                    ! on its presence
  ENDIF
  CALL SUB2(X,Y)
END SUBROUTINE

SUBROUTINE SUB2 (A,B)
  OPTIONAL :: B                 ! B and Y are argument associated,
  IF (PRESENT(B)) THEN         ! even if Y is not present, in
    B = B * A                  ! which case, B is also not present
    PRINT*, B
  ELSE
    A = A**2
    PRINT*, A
  ENDIF
END SUBROUTINE

```

## Related information

- "Optional dummy arguments" on page 186
- "Interface concepts" on page 156
- "PRESENT(A) " on page 630

- “Dummy arguments” on page 182

## PARAMETER

### Purpose

The **PARAMETER** attribute allows you to specify names for constants.

### Syntax

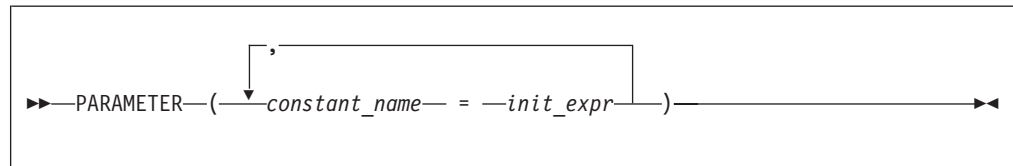

*init\_expr*

An initialization expression.

### Rules

A named constant must have its type, shape, and parameters specified in a previous specification statement in the same scoping unit or be declared implicitly. If a named constant is implicitly typed, its appearance in any subsequent type declaration statement or attribute specification statement must confirm the implied type and any parameter values.

You can define *constant\_name* only once with a **PARAMETER** attribute in a scoping unit.

A named constant that is specified in the initialization expression must have been previously defined (possibly in the same **PARAMETER** or type declaration statement, if not in a previous statement) or made accessible through use or host association.

The initialization expression is assigned to the named constant using the rules for intrinsic assignment. If the named constant is of type character and it has inherited length, it takes on the length of the initialization expression.

#### Attributes compatible with the PARAMETER attribute

- DIMENSION
- PRIVATE
- PUBLIC

### Examples

```

REAL, PARAMETER :: TWO=2.0

COMPLEX      XCONST
REAL         RPART, IPART
PARAMETER    (RPART=1.1, IPART=2.2)
PARAMETER    (XCONST = (RPART, IPART+3.3))

CHARACTER*2, PARAMETER :: BB= '  '
...
END
  
```

## Related information

- “Initialization expressions” on page 95
- “Data objects” on page 17

---

## PAUSE

### Purpose

The **PAUSE** statement temporarily suspends the execution of a program and prints the keyword **PAUSE** and, if specified, a character constant or digit string to unit 0.

### Syntax

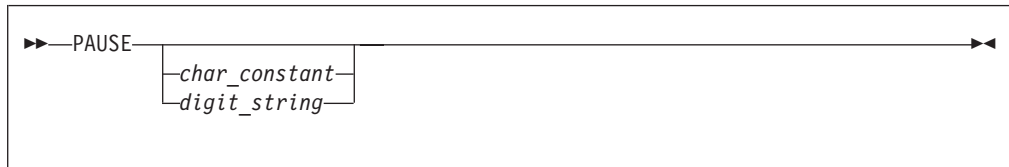

*char\_constant*

is a scalar character constant that is not a Hollerith constant

*digit\_string*

is a string of one to five digits

### Rules

#### IBM Extension

After execution of a **PAUSE** statement, processing continues when you press the **Enter** key. If unit 5 is not connected to the terminal, the **PAUSE** statement does not suspend execution.

End of IBM Extension

#### Fortran 95

The **PAUSE** statement has been deleted in Fortran 95.

End of Fortran 95

### Examples

```
PAUSE 'Ensure backup tape is in tape drive'  
PAUSE 10 ! Output: PAUSE 10
```

## Related information

- “Deleted features” on page 818

---

## POINTER (Fortran 90)

### Purpose

The **POINTER** attribute designates objects as pointer variables.

The term *pointer* refers to objects with the Fortran 90 **POINTER** attribute. The integer **POINTER** statement provides details on what was documented in previous versions of XL Fortran as the **POINTER** statement; these pointers are now referred to as *integer pointers*.

## Syntax

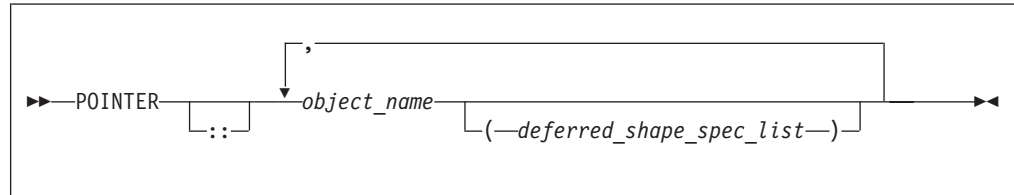

*deferred\_shape\_spec*  
is a colon (:), where each colon represents a dimension

## Rules

*object\_name* refers to a data object or function result. If *object\_name* is declared elsewhere in the scoping unit with the **DIMENSION** attribute, the array specification must be a *deferred\_shape\_spec\_list*.

*object\_name* must not appear in an integer **POINTER**, **NAMELIST**, or **EQUIVALENCE** statement. If *object\_name* is a component of a derived-type definition, any variables declared with that type cannot be specified in an **EQUIVALENCE** or **NAMELIST** statement.

Pointer variables can appear in common blocks and block data program units.

### IBM Extension

To ensure that Fortran 90 pointers are thread-specific, do not specify either the **SAVE** or **STATIC** attribute for the pointer. These attributes are either specified explicitly by the user, or implicitly through the use of the **-qsave** compiler option. Note, however, that if a non-static pointer is used in a pointer assignment statement where the target is static, all references to the pointer are, in fact, references to the static, shared target.

### End of IBM Extension

An object having a component with the **POINTER** attribute can itself have the **TARGET**, **INTENT**, or **ALLOCATABLE** attributes, although it cannot appear in a data transfer statement.

### Attributes compatible with the **POINTER** attribute

- AUTOMATIC
- ASYNCHRONOUS
- DIMENSION
- INTENT
- OPTIONAL
- PRIVATE
- PROTECTED
- PUBLIC
- SAVE
- STATIC
- VOLATILE

These attributes apply only to the pointer itself, not to any associated targets, except for the **DIMENSION** attribute, which applies to associated targets.

## Examples

### Example 1:

```

INTEGER, POINTER :: PTR(:)
INTEGER, TARGET :: TARG(5)
PTR => TARG                                ! PTR is associated with TARG and is
                                           ! assigned an array specification of (5)

PTR(1) = 5                                  ! TARG(1) has value of 5
PRINT *, FUNC()
CONTAINS
  REAL FUNCTION FUNC()
    POINTER :: FUNC                          ! Function result is a pointer
  .
  .
  .
END FUNCTION
END

```

---

### IBM Extension

---

### Example 2: Fortran 90 pointers and threadsafing

```

FUNCTION MYFUNC(ARG)
INTEGER, POINTER :: MYPTR                    ! MYPTR is thread-specific.
                                           ! every thread that invokes
                                           ! 'MYFUNC' will allocate a
ALLOCATE(MYPTR)                             ! new piece of storage that
MYPTR = ARG                                  ! is only accessible within
                                           ! that thread.

ANYVAR = MYPTR
END FUNCTION

```

---

### End of IBM Extension

---

## Related information

- “Data pointer assignment” on page 123
- “TARGET” on page 456
- “ALLOCATED(X)” on page 541
- “DEALLOCATE” on page 318
- “Pointer association” on page 152
- “Deferred-shape arrays” on page 76

---

## POINTER (integer)

---

### IBM Extension

---

### Purpose

The integer **POINTER** statement specifies that the value of the variable *int\_pointer* is to be used as the address for any reference to *pointee*.

The name of this statement has been changed from **POINTER** to integer **POINTER** to distinguish it from the Fortran 90 **POINTER** statement.



## Syntax

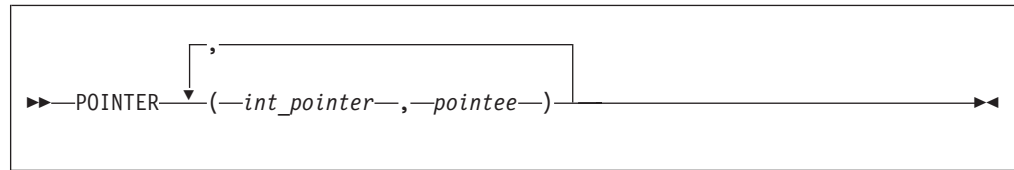

*int\_pointer*

is the name of an integer pointer variable

*pointee* is a variable name or array declarator

## Rules

The compiler does not allocate storage for the pointee. Storage is associated with the pointee at execution time by the assignment of the address of a block of storage to the pointer. The pointee can become associated with either static or dynamic storage. A reference to a pointee requires that the associated pointer be defined.

An integer pointer is a scalar variable of type **INTEGER(4)** in 32-bit mode and type **INTEGER(8)** in 64-bit mode that cannot have a type explicitly assigned to it. You can use integer pointers in any expression or statement in which a variable of the same type as the integer pointer can be used. You can assign any data type to a pointee, but you cannot assign a storage class or initial value to a pointee.

An actual array that appears as a pointee in an integer **POINTER** statement is called a pointee array. You can dimension a pointee array in a type declaration statement, a **DIMENSION** statement, or in the integer **POINTER** statement itself.

If you specify the **-qddim** compiler option, a pointee array that appears in a main program can also have an adjustable array specification. In main programs and subprograms, the dimension size is evaluated when the pointee is referenced (dynamic dimensioning).

If you do not specify the **-qddim** compiler option, a pointee array that appears in a subprogram can have an adjustable array specification, and the dimension size is evaluated on entrance to the subprogram, not when the pointee is evaluated.

The following constraints apply to the definition and use of pointees and integer pointers:

- A pointee cannot be zero-sized.
- A pointee can be scalar, an assumed-sized array or an explicit-shape array.
- A pointee cannot appear in a **COMMON**, **DATA**, **NAMelist**, or **EQUIVALENCE** statement.
- A pointee cannot have the following attributes: **EXTERNAL**, **ALLOCATABLE**, **POINTER**, **TARGET**, **INTRINSIC**, **INTENT**, **OPTIONAL**, **SAVE**, **STATIC**, **AUTOMATIC**, or **PARAMETER**.
- A pointee cannot be a dummy argument and therefore cannot appear in a **FUNCTION**, **SUBROUTINE**, or **ENTRY** statement.
- A pointee cannot be an automatic object, though a pointee can have nonconstant bounds or lengths.
- A pointee cannot be a generic interface block name.

- A pointee that is of derived type must be of sequence derived type.
- A function value cannot be a pointee.
- An integer pointer cannot be pointed to by another pointer. (A pointer cannot be a pointee.)
- An integer pointer cannot have the following attributes:
  - **F2003** **ALLOCATABLE** **F2003**
  - **DIMENSION**
  - **EXTERNAL**
  - **INTRINSIC**
  - **PARAMETER**
  - **POINTER**
  - **TARGET**
- An integer pointer cannot appear as a **NAMELIST** group name.
- An integer pointer cannot be a procedure.

## Examples

```

INTEGER A,B
POINTER (P,I)
IF (A<>0) THEN
  P=LOC(A)
ELSE
  P=LOC(B)
ENDIF
I=0      ! Assigns 0 to either A or B, depending on A's value
END

```

## Related information

- “Integer pointer association” on page 154
- “LOC(X) ” on page 601
- **-qddim Option** in the *XL Fortran Compiler Reference*

End of IBM Extension

## PRINT

### Purpose

The **PRINT** statement is a data transfer output statement.

### Syntax

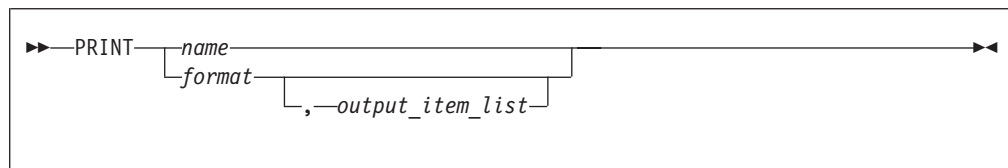

*name* is a namelist group name

*output\_item*

is an output list item. An output list specifies the data to be transferred. An output list item can be:

- A variable. An array is treated as if all of its elements were specified in the order they are arranged in storage.

A pointer must be associated with a target, and an allocatable object must be allocated. A derived-type object cannot have any ultimate component that is inaccessible to this statement. The evaluation of *output\_item* cannot result in a derived-type object that contains a pointer. The structure components of a structure in a formatted statement are treated as if they appear in the order of the derived-type definition; in an unformatted statement, the structure components are treated as a single value in their internal representation (including padding).

- An expression.
- An implied-DO list, as described under “Implied-DO List” on page 416.

Fortran 2003

An expression that is an *output\_item* cannot have a value that is a procedure pointer.

End of Fortran 2003

*format* is a format specifier that specifies the format to be used in the output operation. *format* is a format identifier that can be:

- The statement label of a **FORMAT** statement. The **FORMAT** statement must be in the same scoping unit.
- The name of a scalar **INTEGER(4)** or **INTEGER(8)** variable that was assigned the statement label of a **FORMAT** statement. The **FORMAT** statement must be in the same scoping unit.

Fortran 95

Fortran 95 does not permit assigning of a statement label.

End of Fortran 95

- A character constant. It cannot be a Hollerith constant. It must begin with a left parenthesis and end with a right parenthesis. Only the format codes described in the **FORMAT** statement can be used between the parentheses. Blank characters can precede the left parenthesis, or follow the right parenthesis.
- A character variable that contains character data whose leftmost character positions constitute a valid format. A valid format begins with a left parenthesis and ends with a right parenthesis. Only the format codes listed under “FORMAT” on page 360 can be used between the parentheses. Blank characters can precede the left parenthesis, or follow the right parenthesis.
- An array of noncharacter intrinsic type.
- Any character expression, except one involving concatenation of an operand that specifies inherited length, unless the operand is the name of a constant.
- An asterisk, specifying list-directed formatting.
- A namelist specifier that specifies a previously defined namelist.

Specifying the `-qport=typestmt` compiler option enables the `TYPE` statement which has identical functionality to the `PRINT` statement.

## Implied-DO List

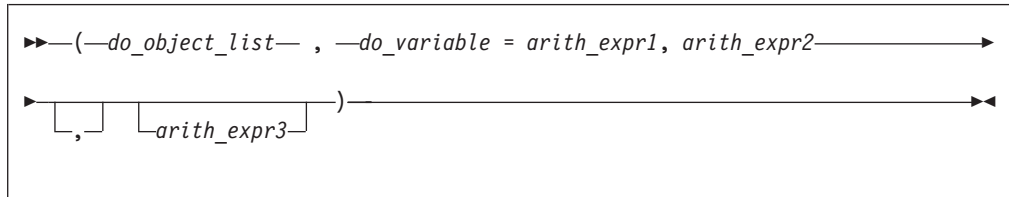

*do\_object*  
is an output list item

*do\_variable*  
is a named scalar variable of type integer or real

*arith\_expr1*, *arith\_expr2*, and *arith\_expr3*  
are scalar numeric expressions

The range of an implied-`DO` list is the list *do\_object\_list*. The iteration count and the values of the `DO` variable are established from *arith\_expr1*, *arith\_expr2*, and *arith\_expr3*, the same as for a `DO` statement. When the implied-`DO` list is executed, the items in the *do\_object\_list* are specified once for each iteration of the implied-`DO` list, with the appropriate substitution of values for any occurrence of the `DO` variable.

## Examples

```
PRINT 10, A,B,C
10 FORMAT (E4.2,G3.2E1,B3)
```

## Related information

- Chapter 9, “XL Fortran Input/Output,” on page 201
- Chapter 10, “Input/Output formatting,” on page 223
- See the *XL Fortran Compiler Reference* for more information on `-qport=typestmt`.
- “Deleted features” on page 818

---

## PRIVATE

### Purpose

The `PRIVATE` attribute specifies that a module entity is not accessible outside the module through use association.

### Syntax



*access\_id*

is a generic specification or the name of a variable, procedure, derived type, constant, or namelist group

## Rules

The **PRIVATE** attribute can appear only in the scope of a module.

Although multiple **PRIVATE** statements can appear in a module, you can only include one statement that omits an *access\_id\_list*. A **PRIVATE** statement without an *access\_id\_list* sets the default accessibility to private for all potentially accessible entities in the module. If the module contains such a statement, it must not include a **PUBLIC** statement without an *access\_id\_list*. If the module does not contain a **PRIVATE** statement without an *access\_id\_list*, the default accessibility is public. Entities whose accessibility is not explicitly specified have default accessibility.

A procedure that has a generic identifier that is public is accessible through that identifier, even if its specific identifier is private. If a module procedure contains a private dummy argument or function result whose type has private accessibility, the module procedure must be declared to have private accessibility and must not have a generic identifier that has public accessibility. The accessibility of a derived type does not affect, and is not affected by, the accessibility of its components or procedures.

A namelist group must be private if it contains any object that is private or contains private components. A subprogram must be private if any of its arguments are of a derived type that is private. A function must be private if its result variable is of a derived type that is private.

### Attributes compatible with the **PRIVATE** attribute

- ALLOCATABLE
- ASYNCHRONOUS
- DIMENSION
- EXTERNAL
- INTRINSIC
- PARAMETER
- POINTER
- PROTECTED
- SAVE
- STATIC
- TARGET
- VOLATILE

## Examples

```
MODULE MC
  PUBLIC                                ! Default accessibility declared as public
  INTERFACE GEN
    MODULE PROCEDURE SUB1, SUB2
  END INTERFACE
  PRIVATE SUB1                          ! SUB1 declared as private
  CONTAINS
    SUBROUTINE SUB1(I)
      INTEGER I
      I = I + 1
    END SUBROUTINE SUB1
    SUBROUTINE SUB2(I,J)
      I = I + J
    END SUBROUTINE
END MODULE MC

PROGRAM ABC
  USE MC
```

```

K = 5
CALL GEN(K)           ! SUB1 referenced because GEN has public
                     ! accessibility and appropriate argument
                     ! is passed

CALL SUB2(K,4)
PRINT *, K           ! Value printed is 10
END PROGRAM

```

## Related information

- Chapter 4, “Derived Types,” on page 47
- “Modules” on page 171
- F2003 “PROTECTED” on page 422 F2003
- “PUBLIC” on page 424

---

## PROCEDURE

### Purpose

A **PROCEDURE** statement appearing within a generic interface adds the specified procedures to the generic interface.

### Syntax

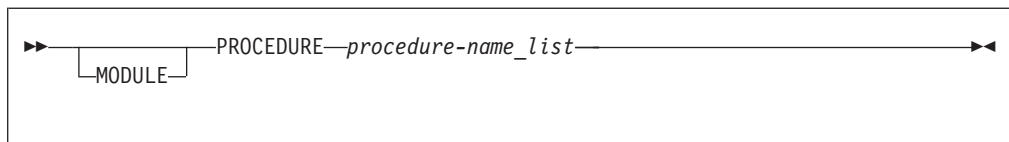

### MODULE

When **MODULE** is specified, *procedure-name\_list* can only contain module procedures. When **MODULE** is not specified, *procedure-name\_list* may contain procedure pointers, external procedures, dummy procedures, or module procedures.

### Rules

---

#### Fortran 95

A **MODULE PROCEDURE** statement can appear anywhere among the interface bodies in an interface block that has a generic specification.

---

#### End of Fortran 95

---

#### Fortran 2003

A **PROCEDURE** statement can only appear in an interface block that has a generic specification.

A *procedure-name* must refer to an accessible procedure pointer, external procedure, dummy procedure, or module procedure and must have an explicit interface.

If the **MODULE** keyword appears, each procedure name has to be a module procedure and has to be accessible in the current scope.

A *procedure-name* must not specify a procedure that is specified previously in any **PROCEDURE** statement in any accessible interface with the same generic identifier.

End of Fortran 2003

## Examples

```

MODULE M
  CONTAINS
  SUBROUTINE S1(IARG)
    IARG=1
    PRINT *, "In S1"
  END SUBROUTINE
  SUBROUTINE S2(RARG)
    RARG=1.1
  END SUBROUTINE
END MODULE

USE M
INTERFACE SS
  SUBROUTINE SS1(IARG,JARG)
  END SUBROUTINE
  MODULE PROCEDURE S1, S2
END INTERFACE
CALL SS(N)           ! Calls subroutine S1 from M
CALL SS(I,J)        ! Calls subroutine SS1
END
SUBROUTINE SS1(IARG,JARG)
  PRINT *, "In SS1"
END SUBROUTINE SS1

```

## Related information

- “Interface blocks” on page 158
- “INTERFACE” on page 389
- “Modules” on page 171

## PROCEDURE declaration

Fortran 2003

### Purpose

A **PROCEDURE** declaration statement declares a dummy procedure, an external procedure, or a procedure pointer. It specifies the **EXTERNAL** attribute for these entities.

### Syntax

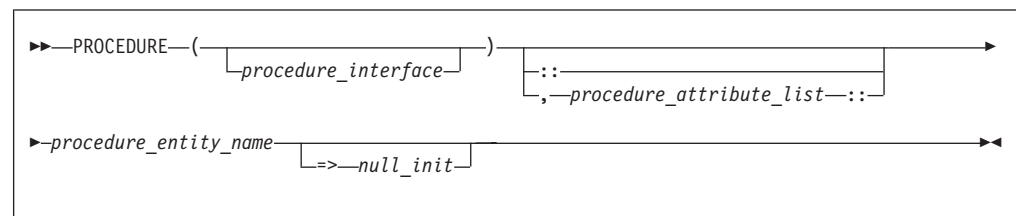

*procedure\_interface*

A declaration type specifier or the name of a procedure that has an explicit interface.

*procedure\_attribute\_list*

A list of attributes from the following list:

- **BIND**
- **INTENT**(*intent\_spec*)
- **OPTIONAL**
- **POINTER**
- **PRIVATE**
- **PUBLIC**
- **SAVE**

*procedure\_entity\_name*

is the name of the procedure or procedure pointer that is being declared.

*null\_init*

is a reference to the NULL intrinsic function.

## Rules

If *procedure\_interface* is the name of a procedure or procedure pointer that has an explicit interface, the declared procedures or procedure pointers have this explicit interface. The *procedure\_interface* must already be declared. The name of the *procedure\_interface* cannot be the same as a keyword that specifies an intrinsic type. The *procedure\_interface* can be an intrinsic procedure as long as the intrinsic procedure can be passed as an actual argument. If the *procedure\_interface* is an elemental procedure, the procedure entity names must consist of external procedures.

If *procedure\_interface* is a declaration type specifier, the declared procedures or procedure pointers are functions with an implicit interface and the specified result type. If these functions are external functions, the function definitions must specify the same result type and type parameters.

If no *procedure\_interface* is specified, the **PROCEDURE** declaration statement specifies that the declared procedures or procedure pointers are either subroutines or functions. If they are functions, the implicit type rule applies to the type of the function.

If you specify procedure language binding using the **BIND** attribute, *procedure\_interface* must be the name of a procedure or procedure pointer that is declared with procedure language binding.

If procedure language binding with **NAME=** is specified, the procedure entity name must consist of only one procedure entity name. This procedure must not be a dummy procedure or have the **POINTER** attribute.

If **OPTIONAL** is specified, the declared procedures or procedure pointers must be dummy procedures or procedure pointers.

You can only specify **PUBLIC** or **PRIVATE** if the statement appears in the specification part of a module.



If **INTENT**, **SAVE**, or *null\_init* is specified, the declared entities must have the **POINTER** attribute.

If *null\_init* is used, it specifies that the initial association status of the corresponding procedure pointer is disassociated. It also implies the **SAVE** attribute, which can be reaffirmed by explicitly using the **SAVE** attribute in the procedure declaration statement or by a **SAVE** statement.

For procedure pointer declarations, you must specify the **POINTER** attribute.

## Examples

### Example 1

The following example shows an external procedure declaration.

```
CONTAINS
SUBROUTINE XXX(PSI)
  PROCEDURE (REAL) :: PSI
  REAL Y1
  Y1 = PSI()
END SUBROUTINE
END
```

### Example 2

The following example shows a procedure pointer declaration and its use.

```
PROGRAM PROC_PTR_EXAMPLE
  REAL :: R1
  INTEGER :: I1
  INTERFACE
    SUBROUTINE SUB(X)
      REAL, INTENT(IN) :: X
    END SUBROUTINE SUB
    FUNCTION REAL_FUNC(Y)
      REAL, INTENT(IN) :: Y
      REAL, REAL_FUNC
    END FUNCTION REAL_FUNC
  END INTERFACE
  PROCEDURE(SUB), POINTER :: PTR_TO_SUB           ! with explicit interface
  PROCEDURE(REAL_FUNC), POINTER :: PTR_TO_REAL_FUNC => NULL() ! with explicit interface
  PROCEDURE(INTEGER), POINTER :: PTR_TO_INT       ! with implicit interface
  PTR_TO_SUB => SUB
  PTR_TO_REAL_FUNC => REAL_FUNC
  CALL PTR_TO_SUB(1.0)
  R1 = PTR_TO_REAL_FUNC(2.0)
  I1 = PTR_TO_INT(M, N)
END PROGRAM PROC_PTR_EXAMPLE
```

## Related information

- “**BIND**” on page 285
- Chapter 14, “Intrinsic procedures,” on page 529
- Chapter 15, “Hardware-specific intrinsic procedures,” on page 671
- “Program units, procedures, and subprograms” on page 154
- “Intrinsic procedures” on page 179
- “**INTERFACE**” on page 389
- “Procedure pointer assignment” on page 126

End of Fortran 2003

---

## PROGRAM

### Purpose

The **PROGRAM** statement specifies that a program unit is a main program, the program unit that receives control from the system when the executable program is invoked at run time.

### Syntax

```
▶▶PROGRAM name◀◀
```

*name* is the name of the main program in which this statement appears

### Rules

The **PROGRAM** statement is optional.

If specified, the **PROGRAM** statement must be the first statement of the main program.

If a program name is specified in the corresponding **END** statement, it must match *name*.

The program name is global to the executable program. This name must not be the same as the name of any common block, external procedure, or any other program unit in that executable program, or as any name that is local to the main program.

The name has no type, and it must not appear in any type declaration or specification statements. You cannot refer to a main program from a subprogram or from itself.

### Examples

```
PROGRAM DISPLAY_NUMBER_2
  INTEGER A
  A = 2
  PRINT *, A
END PROGRAM DISPLAY_NUMBER_2
```

### Related information

- “END” on page 335
- “Main program” on page 170

---

## PROTECTED

Fortran 2003

### Purpose

The **PROTECTED** attribute allows greater control over the modification of module entities. A module procedure can only modify a protected module entity or its subobjects if the same module defines both the procedure and the entity.

## Syntax

The **PROTECTED** attribute must only appear in the specification part of the module.

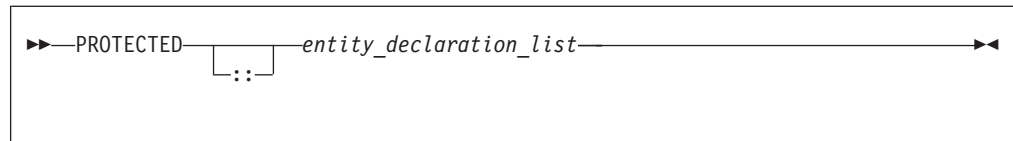

*entity* A named variable not in a common block.

## Rules

If you specify that an object declared by an **EQUIVALENCE** statement has the **PROTECTED** attribute, all objects specified in that **EQUIVALENCE** statement must have the **PROTECTED** attribute.

A nonpointer object with the **PROTECTED** attribute accessed through use association, is not definable.

You must not specify the **PROTECTED** attribute for integer pointers.

A pointer object with the **PROTECTED** attribute accessed through use association, must not appear as any of the following:

- As a pointer object in a **NULLIFY** statement or **POINTER** assignment statement
- As an allocatable object in an **ALLOCATE** or **DEALLOCATE** statement.
- As an actual argument in reference to a procedure, if the associated dummy argument is a pointer with the **INTENT(INOUT)** or **INTENT(OUT)** attribute.

### Attributes compatible with the **PROTECTED** attribute

- **ALLOCATABLE**
- **OPTIONAL**
- **SAVE**
- **ASYNCHRONOUS**
- **POINTER**
- **STATIC**
- **AUTOMATIC**
- **PRIVATE**
- **TARGET**
- **DIMENSION**
- **PUBLIC**
- **VOLATILE**
- **INTENT**

## Examples

In the following example, the values of both *age* and *val* can only be modified by subroutines in the module in which they are declared:

```
module mod1
  integer, protected :: val
  integer :: age
  protected :: age
  contains
    subroutine set_val(arg)
      integer arg
      val = arg
    end subroutine
    subroutine set_age(arg)
      integer arg
      age = arg
    end subroutine
end module
```

```

end module
program dt_init01
  use mod1
  implicit none
  integer :: value, his_age
  call set_val(88)
  call set_age(38)
  value = val
  his_age = age
  print *, value, his_age
end program

```

## Related information

- “Modules” on page 171
- “PRIVATE” on page 416
- “PUBLIC”

End of Fortran 2003

## PUBLIC

### Purpose

The **PUBLIC** attribute specifies that a module entity can be accessed by other program units through use association.

### Syntax

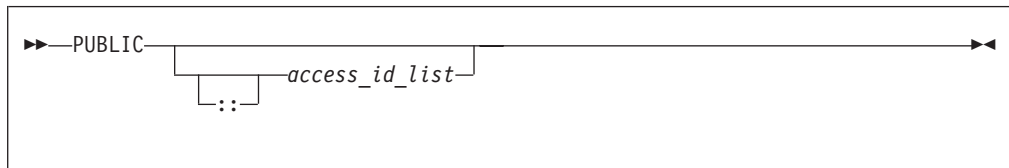

*access\_id*

is a generic specification or the name of a variable, procedure, derived type, constant, or namelist group

### Rules

The **PUBLIC** attribute can appear only in the scope of a module.

Although multiple **PUBLIC** statements can appear in a module, only one statement that omits an *access\_id\_list* is permitted. A **PUBLIC** statement without an *access\_id\_list* sets the default accessibility to public for all potentially accessible entities in the module. If the module contains such a statement, it cannot also include a **PRIVATE** statement without an *access\_id\_list*. If the module does not contain a **PRIVATE** statement without an *access\_id\_list*, the default accessibility is public. Entities whose accessibility is not explicitly specified have default accessibility.

A procedure that has a generic identifier that is public is accessible through that identifier, even if its specific identifier is private. If a module procedure contains a private dummy argument or function result whose type has private accessibility,

the module procedure must be declared to have private accessibility and must not have a generic identifier that has public accessibility.

#### IBM Extension

Although an entity with public accessibility cannot have the **STATIC** attribute, public entities in a module are unaffected by **IMPLICIT STATIC** statements in the module.

#### End of IBM Extension

#### Attributes compatible with the PUBLIC attribute

- ALLOCATABLE
- ASYNCHRONOUS(1)
- DIMENSION
- EXTERNAL
- INTRINSIC
- PARAMETER
- POINTER
- PROTECTED (1)
- SAVE
- TARGET
- VOLATILE (1)

#### Notes:

1. Fortran 2003 Standard

## Examples

```
MODULE MC
  PRIVATE
  PUBLIC GEN
  INTERFACE GEN
    MODULE PROCEDURE SUB1
  END INTERFACE
  CONTAINS
    SUBROUTINE SUB1(I)
      INTEGER I
      I = I + 1
    END SUBROUTINE SUB1
END MODULE MC
PROGRAM ABC
  USE MC
  K = 5
  CALL GEN(K)

  PRINT *, K
END PROGRAM
```

! Default accessibility declared as private  
! GEN declared as public

! SUB1 referenced because GEN has public  
! accessibility and appropriate argument  
! is passed  
! Value printed is 6

## Related information

- “PRIVATE” on page 416
- “PROTECTED” on page 422
- “Modules” on page 171

---

## READ

### Purpose

The **READ** statement is the data transfer input statement.

## Syntax

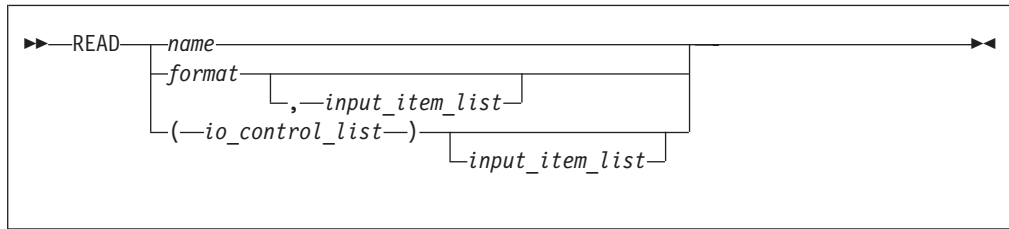

*format* A format identifier that must not be a Hollerith constant. See **FMT=***format* for more information.

*name* A namelist group name.

*input\_item*

An input list item. An input list specifies the data to be transferred. An input list item can be:

- A variable name, but not for an assumed-size array. An array is treated as if all of its elements were specified in the order they are arranged in storage.

A pointer must be associated with a definable target, and an allocatable object must be allocated. A derived-type object cannot have any ultimate component that is outside the scoping unit of this statement. The evaluation of *input\_item* cannot result in a derived-type object that contains a pointer. The structure components of a structure in a formatted statement are treated as if they appear in the order of the derived-type definition; in an unformatted statement, the structure components are treated as a single value in their internal representation (including padding).

- An implied-**DO** list, as described under “Implied-DO List” on page 433.

### Fortran 2003

An *input\_item* must not be a procedure pointer.

### End of Fortran 2003

*io\_control*

is a list that must contain one unit specifier (**UNIT=**) and can also contain one of each of the other valid specifiers described below.

**[UNIT=]** *u*

is a unit specifier that specifies the unit to be used in the input operation. *u* is an external unit identifier or internal file identifier.

### IBM Extension

An external unit identifier refers to an external file. It is one of the following:

- An integer expression whose value is in the range 0 through 2,147,483,647.
- An asterisk, which identifies external unit 5 and is preconnected to standard input.

An internal file identifier refers to an internal file. It is the name of a character variable that cannot be an array section with a vector subscript.

If the optional characters **UNIT=** are omitted, *u* must be the first item in *io\_control\_list*. If the optional characters **UNIT=** are specified, either the optional characters **FMT=** or the optional characters **NML=** must also be present.

**[FMT=]** *format*

is a format specifier that specifies the format to be used in the input operation. *format* is a format identifier that can be:

- The statement label of a **FORMAT** statement. The **FORMAT** statement must be in the same scoping unit.
- The name of a scalar **INTEGER(4)** or **INTEGER(8)** variable that was assigned the statement label of a **FORMAT** statement. The **FORMAT** statement must be in the same scoping unit.

Fortran 95

Fortran 95 does not permit assigning of a statement label.

End of Fortran 95

- A character constant. It must begin with a left parenthesis and end with a right parenthesis. Only the format codes described in the **FORMAT** statement can be used between the parentheses. Blank characters can precede the left parenthesis, or follow the right parenthesis.
- A character variable that contains character data whose leftmost character positions constitute a valid format. A valid format begins with a left parenthesis and ends with a right parenthesis. Only the format codes listed under “FORMAT” on page 360 can be used between the parentheses. Blank characters can precede the left parenthesis or follow the right parenthesis. If *format* is an array element, the format identifier must not exceed the length of the array element.
- An array of noncharacter intrinsic type. The data must be a valid format identifier as described under character array.
- Any character expression, except one involving concatenation of an operand that specifies inherited length, unless the operand is the name of a constant.
- An asterisk, specifying list-directed formatting.
- A namelist specifier that specifies a previously-defined namelist.

If the optional characters **FMT=** are omitted, *format* must be the second item in *io\_control\_list* and the first item must be the unit specifier with the optional characters **UNIT=** omitted. Both **NML=** and **FMT=** cannot be specified in the same input statement.

**ADVANCE=** *char\_expr*

is an advance specifier that determines whether nonadvancing input occurs for this statement. *char\_expr* is a scalar character expression that must evaluate to **YES** or **NO**. If **NO** is specified, nonadvancing input occurs. If **YES** is specified, advancing, formatted sequential or stream input occurs. The default value is **YES**. **ADVANCE=** can be specified only in a formatted

sequential or formatted stream **READ** statement with an explicit format specification that does not specify an internal file unit specifier.

---

**IBM Extension**

---

**ASYNCH=** *char\_expr*

is an asynchronous I/O specifier that indicates whether an explicitly connected unit is to be used for asynchronous I/O.

*char\_expr* is a scalar character expression whose value is either **YES** or **NO**. **YES** specifies that asynchronous data transfer statements are permitted for this connection. **NO** specifies that asynchronous data transfer statements are not permitted for this connection. The value specified will be in the set of transfer methods permitted for the file. If this specifier is omitted, the default value is **NO**.

Preconnected units are connected with an **ASYNCH=** value of **NO**.

The **ASYNCH=** value of an implicitly connected unit is determined by the first data transfer statement performed on the unit. If the first statement performs an asynchronous data transfer and the file being implicitly connected permits asynchronous data transfers, the **ASYNCH=** value is **YES**. Otherwise, the **ASYNCH=** value is **NO**.

---

**End of IBM Extension**

---

---

**Fortran 2003**

---

**ASYNCHRONOUS=***char\_expr*

allows execution to continue without waiting for the data transfer to complete. *char\_expr* is a scalar character expression that must evaluate to **YES** or **NO**. **ASYNCHRONOUS=YES** must not appear unless **UNIT=** specifies a file unit number. If **ID=** appears, an **ASYNCHRONOUS=YES** must also appear.

A statement and the I/O operation are synchronous if **ASYNCHRONOUS=NO** or if both **ASYNCHRONOUS=** and **ID=** are absent. For **ASYNCHRONOUS=YES** or if **ID=** appears, asynchronous I/O is permitted only for external files opened with **ASYNCHRONOUS=YES** in the **OPEN** statement.

If a variable is used in an asynchronous data transfer statement as an item in an I/O list, a group object in a namelist or as a **SIZE=** specifier, the base object of the *data\_ref* is implicitly given the **ASYNCHRONOUS** attribute in the scoping unit of the data transfer statement. For asynchronous nonadvancing input, the storage units specified in the **SIZE=** specifier become defined with the count of the characters transferred when the corresponding wait operation is executed. For asynchronous output, a pending I/O storage sequence affector shall not be redefined, become undefined, or have its pointer association status changed. For asynchronous input, a pending I/O storage sequence affector shall not be referenced, become defined, become undefined, become associated with a dummy argument that has the **VALUE** attribute, or have its pointer association status changed.

When an error, end-of-file or end-of-record condition occurs for a previously executed asynchronous data transfer statement, a wait operation is performed for all pending data transfer operations on that



unit. When a condition occurs during a subsequent statement, any actions specified by **IOSTAT=**, **IOMSG=**, **ERR=**, **END=**, and **EOR=** specifiers for that statement are taken.

A wait operation is performed by a **WAIT**, **CLOSE**, or file positioning statement.

End of Fortran 2003

**END=** *stmt\_label*

is an end-of-file specifier that specifies a statement label at which the program is to continue if an endfile record is encountered and no error occurs. An external file is positioned after the endfile record; the **IOSTAT=** specifier, if present, is assigned a negative value; and the **NUM=** specifier, if present, is assigned an integer value. If an error occurs and the statement contains the **SIZE=** specifier, the specified variable becomes defined with an integer value. Coding the **END=** specifier suppresses the error message for end-of-file. This specifier can be specified for a unit connected for either sequential or direct access.

**EOR=** *stmt\_label*

is an end-of-record specifier. If the specifier is present, an end-of-record condition occurs, and no error condition occurs during execution of the statement. If **PAD=** exists, the following also occur:

1. If the **PAD=** specifier has the value **YES**, the record is padded with blanks to satisfy the input list item and the corresponding data edit descriptor that requires more characters than the record contains.
2. Execution of the **READ** statement terminates.
3. The file specified in the **READ** statement is positioned after the current record.
4. If the **IOSTAT=** specifier is present, the specified variable becomes defined with a negative value different from an end-of-file value.
5. If the **SIZE=** specifier is present, the specified variable becomes defined with an integer value.
6. Execution continues with the statement containing the statement label specified by the **EOR=** specifier.
7. End-of-record messages are suppressed.

Fortran 2003

**BLANK=** *char\_expr*

controls the default interpretation of blanks when you are using a format specification. *char\_expr* is a scalar character expression whose value, when any trailing blanks are removed, is either **NULL** or **ZERO**. If **BLANK=** is specified, you must use **FORM='FORMATTED'**. If **BLANK=** is not specified and you specify **FORM='FORMATTED'**, **NULL** is the default.

End of Fortran 2003

Fortran 2003

**DECIMAL=** *char\_expr*

temporarily changes the default decimal edit mode for the duration of an I/O statement. *char\_expr* is a scalar character expression whose value must evaluate to either **POINT**, or **COMMA**. After each **READ** statement, the

mode defaults to whatever decimal mode was specified (or assumed) on the **OPEN** statement for that unit.

End of Fortran 2003

**ERR=** *stmt\_label*

is an error specifier that specifies the statement label of an executable statement to which control is to transfer in the case of an error. Coding the **ERR=** specifier suppresses error messages.

IBM Extension

**ID=** *integer\_variable*

indicates that the data transfer is to be done asynchronously. The *integer\_variable* is an integer variable. If no error is encountered, the *integer\_variable* is defined with a value after executing the asynchronous data transfer statement. This value must be used in the matching **WAIT** statement.

Fortran 2003

A child data transfer statement must not contain the **ID=** specifier.

End of Fortran 2003

Asynchronous data transfer must either be direct unformatted, sequential unformatted or stream unformatted. Asynchronous I/O to internal files is prohibited. Asynchronous I/O to raw character devices (for example, to tapes or raw logical volumes) is prohibited. The *integer\_variable* must not be associated with any entity in the data transfer I/O list, or with a *do\_variable* of an *io\_implied\_do* in the data transfer I/O list. If the *integer\_variable* is an array element reference, its subscript values must not be affected by the data transfer, the *io\_implied\_do* processing, or the definition or evaluation of any other specifier in the *io\_control\_spec*.

End of IBM Extension

Fortran 2003

**IOMSG=** *iomsg\_variable*

is an input/output status specifier that specifies the message returned by the input/output operation. *iomsg\_variable* is a scalar default character variable. It must not be a use-associated nonpointer protected variable. When the input/output statement containing this specifier finishes execution, *iomsg\_variable* is defined as follows:

- If an error, end-of-file, or end-of-record condition occurs, the variable is assigned an explanatory message as if by assignment.
- If no such condition occurs, the value of the variable is unchanged.

End of Fortran 2003

**IOSTAT=** *ios*

is an input/output status specifier that specifies the status of the input/output operation. *ios* is an integer variable. Coding the **IOSTAT=** specifier suppresses error messages. When the statement finishes execution, *ios* is defined with:

- A zero value if no error condition, end-of-file condition, or end-of-record condition occurs.
- A positive value if an error occurs.
- A negative value if an end-of-file condition is encountered and no error occurs.
- A negative value that is different from the end-of-file value if an end-of-record condition occurs and no error condition or end-of-file condition occurs.

---

**Fortran 2003**

---

**PAD=** *char\_expr*

specifies if input records are padded with blanks. *char\_expr* is a scalar character expression that must evaluate to **YES** or **NO**. If the value is **YES**, a formatted input record is padded with blanks if an input list is specified and the format specification requires more data from a record than the record contains. If **NO** is specified, the input list and format specification must not require more characters from a record than the record contains. The default value is **YES**. The **PAD=** specifier is permitted only for files being connected for formatted input/output, although it is ignored during output of a formatted record.

---

**IBM Extension**

---

If the **-qxlf77** compiler option specifies the **noblankpad** suboption and the file is being connected for formatted direct input/output, the default value is **NO** when the **PAD=** specifier is omitted.

---

**End of IBM Extension**

---



---

**End of Fortran 2003**

---

**[NML=]** *name*

is a namelist specifier that specifies a previously-defined namelist. If the optional characters **NML=** are not specified, the namelist name must appear as the second parameter in the list and the first item must be the unit specifier with **UNIT=** omitted. If both **NML=** and **UNIT=** are specified, all the parameters can appear in any order. The **NML=** specifier is an alternative to **FMT=**; both **NML=** and **FMT=** cannot be specified in the same input statement.

---

**IBM Extension**

---

**NUM=** *integer\_variable*

is a number specifier that specifies the number of bytes of data transmitted between the I/O list and the file. *integer\_variable* is an integer variable. The **NUM=** specifier is only permitted for unformatted output. Coding the **NUM** parameter suppresses the indication of an error that would occur if the number of bytes represented by the output list is greater than the number of bytes that can be written into the record. In this case, *integer\_variable* is set to a value that is the maximum length record that can be written. Data from remaining output list items is not written into subsequent records.

**POS=***integer\_expr*

► **F2003** is an integer expression greater than 0. **POS=** specifies the file position of the file storage unit to be read in a file connected for stream access. You must not use this specifier for a file that cannot be positioned or in a child data transfer statement. ◀ **F2003**

End of Fortran 2003

**REC=** *integer\_expr*

is a record specifier that specifies the number of the record to be read.

► **F2003** If the control information list contains a **REC=** specifier, the statement is a direct access input/output statement. You must not use this specifier in a child data transfer statement. ◀ **F2003**

*integer\_expr* is an integer expression whose value is positive. A record specifier is not valid if list-directed or namelist formatting is used and if the unit specifier specifies an internal file. ► **IBM** The **END=** specifier can appear concurrently. ◀ **IBM** The record specifier represents the relative position of a record within a file. The relative position number of the first record is 1. You must not specify **REC=** in data transfer statements that specify a unit connected for stream access, or use the **POS=** specifier.

**ROUND=** *char\_expr*

temporarily changes the current value of the I/O rounding mode for the duration of this I/O statement. If omitted, then the rounding mode is unchanged. *char\_expr* evaluates to either **UP**, **DOWN**, **ZERO**, **NEAREST**, **COMPATIBLE** or **PROCESSOR\_DEFINED**

The rounding mode helps specify how decimal numbers are converted to an internal representation, (that is, in binary) from a character representation and vice versa during formatted input and output. The rounding modes have the following functions:

- In the **UP** rounding mode the value from the conversion is the smallest value that is greater than or equal to the original value.
- In the **DOWN** rounding mode the value from the conversion is the greatest value that is smaller than or equal to the original value.
- In the **ZERO** rounding mode the value from the conversion is the closest value to the original value, and not greater in magnitude.
- In the **NEAREST** rounding mode the value from the conversion is the closer of the two nearest representable values. If both values are equally close then the even value will be chosen. In IEEE rounding conversions, **NEAREST** corresponds to the `ieee_nearest` rounding mode as specified by the IEEE standard.
- In the **COMPATIBLE** rounding mode the value from the conversion is the closest of the two nearest representable values, or the value further away from zero if halfway between.
- In the **PROCESSOR\_DEFINED** rounding mode the value from the conversion is processor dependent and may correspond to the other

modes. In the **PROCESSOR\_DEFINED** rounding mode the value from the conversion is processor dependent and may correspond to the other modes. In XL Fortran, the **PROCESSOR\_DEFINED** rounding mode will be the rounding mode you choose in the floating-point control register. If you do not set the floating-point control register explicitly, the default rounding mode is **NEAREST**.

End of Fortran 2003

**SIZE=** *count*

A character count specifier that determines how many characters are transferred by data edit descriptors during execution of the current input statement. *count* is an integer variable. Blanks that are inserted as padding are not included in the count.

### Implied-DO List

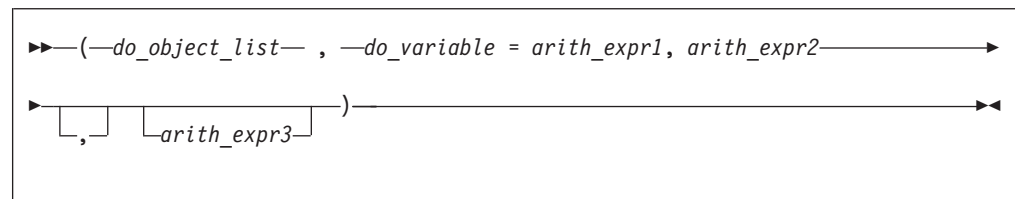

*do\_object*

is an output list item

*do\_variable*

is a named scalar variable of type integer or real

*arith\_expr1*, *arith\_expr2*, and *arith\_expr3*

are scalar numeric expressions

The range of an implied-**DO** list is the list *do\_object\_list*. The iteration count and the values of the **DO** variable are established from *arith\_expr1*, *arith\_expr2*, and *arith\_expr3*, the same as for a **DO** statement. When the implied-**DO** list is executed, the items in the *do\_object\_list* are specified once for each iteration of the implied-**DO** list, with the appropriate substitution of values for any occurrence of the **DO** variable.

The **DO** variable or an associated data item must not appear as an input list item in the *do\_object\_list*, but can be read in the same **READ** statement outside of the implied-**DO** list.

### Rules

Any statement label specified by the **ERR=**, **EOR=** and **END=** specifiers must refer to a branch target statement that appears in the same scoping unit as the **READ** statement.

If either the **EOR=** specifier or the **SIZE=** specifier is present, the **ADVANCE=** specifier must also be present and must have the value **NO**.

IBM Extension

If a **NUM=** specifier is present, neither a format specifier nor a namelist specifier

can be present.

End of IBM Extension

Variables specified for the **IOSTAT=**, **SIZE=** and **NUM=** specifiers must not be associated with any input list item, namelist list item, or the **DO** variable of an implied-**DO** list. If such a specifier variable is an array element, its subscript values must not be affected by the data transfer, any implied-**DO** processing, or the definition or evaluation of any other specifier.

A **READ** statement without *io\_control\_list* specified specifies the same unit as a **READ** statement with *io\_control\_list* specified in which the external unit identifier is an asterisk.

If the **ERR=** and **IOSTAT=** specifiers are set and an error is encountered during a synchronous data transfer, transfer is made to the statement specified by the **ERR=** specifier and a positive integer value is assigned to *ios*.

IBM Extension

If the **ERR=** or **IOSTAT=** specifiers are set and an error is encountered during an asynchronous data transfer, execution of the matching **WAIT** statement is not required.

If the **END=** or **IOSTAT=** specifiers are set and an end-of-file condition is encountered during an asynchronous data transfer, execution of the matching **WAIT** statement is not required.

If a conversion error is encountered and the **CNVERR** run-time option is set to **NO**, **ERR=** is not branched to, although **IOSTAT=** may be set.

If **IOSTAT=** and **ERR=** are not specified,

- The program stops if a severe error is encountered.
- The program continues to the next statement if a recoverable error is encountered and the **ERR\_RECOVERY** run-time option is set to **YES**. If the option is set to **NO**, the program stops.
- The program continues to the next statement when a conversion error is encountered if the **ERR\_RECOVERY** run-time option is set to **YES**. If the **CNVERR** run-time option is set to **YES**, conversion errors are treated as recoverable errors; if **CNVERR=NO**, they are treated as conversion errors.

End of IBM Extension

## Examples

```
INTEGER A(100)
CHARACTER*4 B
READ *, A(LBOUND(A,1):UBOUND(A,1))
READ (7,FMT='(A3)',ADVANCE='NO',EOR=100) B
...
100 PRINT *, 'end of record reached'
END
```

## Related information

- “Asynchronous Input/Output” on page 207

- *Implementation details of XL Fortran Input/Output* in the *XL Fortran Optimization and Programming Guide*
- “Conditions and IOSTAT values” on page 214
- “WRITE” on page 481
- “WAIT” on page 476
- Chapter 9, “XL Fortran Input/Output,” on page 201
- *Setting run-time options* in the *XL Fortran Compiler Reference*
- “Deleted features” on page 818

## REAL

### Purpose

A **REAL** type declaration statement specifies the length and attributes of objects and functions of type real. Initial values can be assigned to objects.

### Syntax

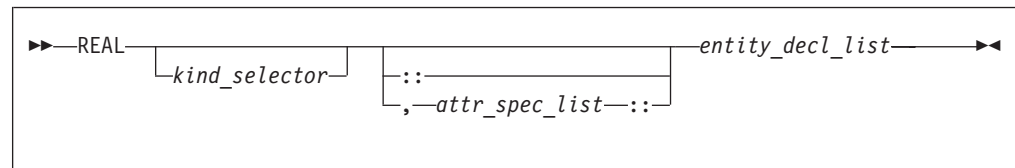

where:

<i>attr_spec</i>
<b>ALLOCATABLE</b>
<b>ASYNCHRONOUS</b>
<b>AUTOMATIC</b>
<b>BIND</b>
<b>DIMENSION</b> ( <i>array_spec</i> )
<b>EXTERNAL</b>
<b>INTENT</b> ( <i>intent_spec</i> )
<b>INTRINSIC</b>
<b>OPTIONAL</b>
<b>PARAMETER</b>
<b>POINTER</b>
<b>PRIVATE</b>
<b>PROTECTED</b>
<b>PUBLIC</b>
<b>SAVE</b>
<b>STATIC</b>
<b>TARGET</b>
<b>VALUE</b>
<b>VOLATILE</b>

*kind\_selector*

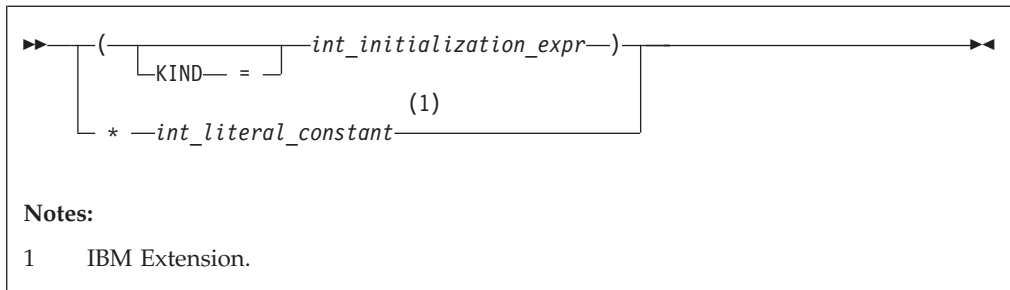

**IBM Extension**

specifies the length of real entities: 4, 8 or 16. *int\_literal\_constant* cannot specify a kind type parameter.

**End of IBM Extension**

*attr\_spec*

For detailed information on rules about a particular attribute, refer to the statement of the same name.

*intent\_spec*

is either **IN**, **OUT**, or **INOUT**

:: is the double colon separator. Use the double colon separator when you specify attributes, =*initialization\_expr*, **F95** or => **NULL0** **F95**.

*array\_spec*

is a list of dimension bounds

*entity\_decl*

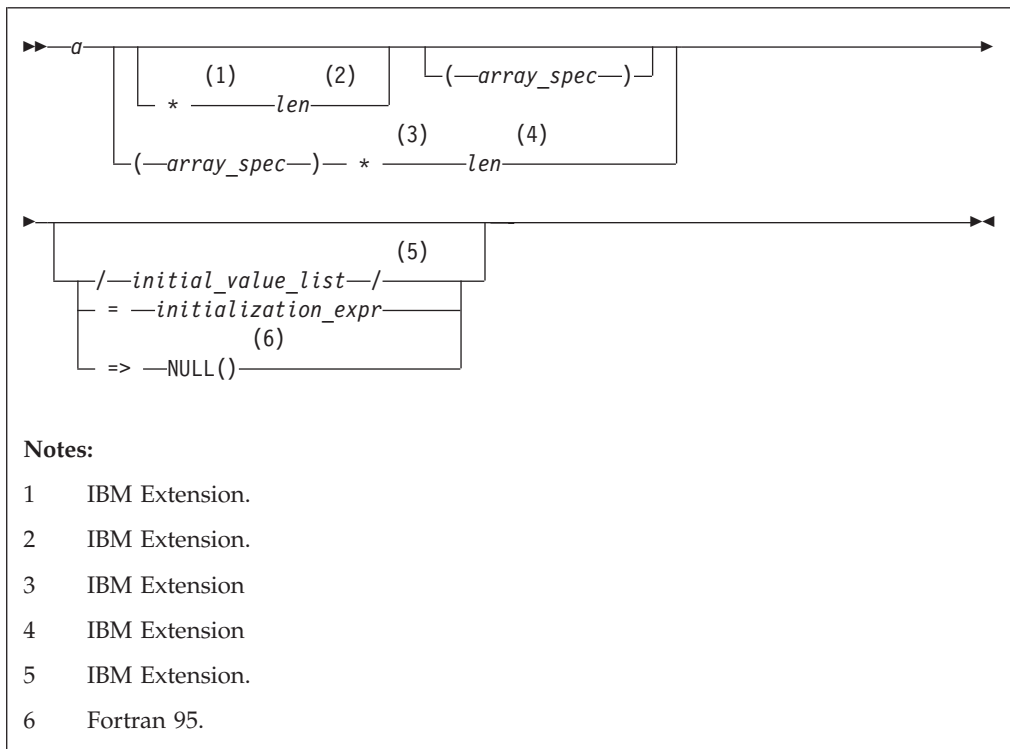



*a* is an object name or function name. *array\_spec* cannot be specified for a function name with an implicit interface.

IBM Extension

*len* overrides the length as specified in *kind\_selector*, and cannot specify a kind type parameter. The entity length must be an integer literal constant that represents one of the permissible length specifications.

End of IBM Extension

IBM Extension

*initial\_value* provides an initial value for the entity specified by the immediately preceding name.

End of IBM Extension

*initialization\_expr* provides an initial value, by means of an initialization expression, for the entity specified by the immediately preceding name

Fortran 95

=> **NULL()**  
provides the initial value for the pointer object

End of Fortran 95

## Rules

Fortran 95

Within the context of a derived type definition:

- If => appears in a component initialization, the **POINTER** attribute must appear in the *attr\_spec\_list*.
- If = appears in a component initialization, the **POINTER** attribute cannot appear in the component *attr\_spec\_list*.
- The compiler will evaluate *initialization\_expr* within the scoping unit of the type definition.

If => appears for a variable, the object must have the **POINTER** attribute.

End of Fortran 95

If *initialization\_expr* appears for a variable, the object cannot have the **POINTER** attribute.

Entities in type declaration statements are constrained by the rules of any attributes specified for the entities, as detailed in the corresponding attribute statements.

The type declaration statement overrides the implicit type rules in effect. You can use a type declaration statement that confirms the type of an intrinsic function. The appearance of a generic or specific intrinsic function name in a type declaration statement does not cause the name to lose its intrinsic property.

An object cannot be initialized in a type declaration statement if it is a dummy argument, an allocatable object, a function result, an object in a blank common block, an integer pointer, an external name, an intrinsic name, or an automatic object. Nor can an object be initialized if it has the **AUTOMATIC** attribute. The object may be initialized if it appears in a named common block in a block data program unit.

IBM Extension

The object also may be initialized if it appears in a named common block in a module.

End of IBM Extension

Fortran 95

In Fortran 95, a pointer can be initialized. Pointers can only be initialized by the use of `=> NULL()`.

End of Fortran 95

The specification expression of an *array\_spec* can be a nonconstant expression if the specification expression appears in an interface body or in the specification part of a subprogram. Any object being declared that uses this nonconstant expression and is not a dummy argument or a pointee is called an *automatic object*.

An attribute cannot be repeated in a given type declaration statement, nor can an entity be explicitly given the same attribute more than once in a scoping unit.

*initialization\_expr* must be specified if the statement contains the **PARAMETER** attribute. If the entity you are declaring is a variable, and *initialization\_expr* F95 or `NULL()` F95 is specified, the variable is initially defined.

Fortran 95

If the entity you are declaring is a derived type component, and *initialization\_expr* or `NULL()` is specified, the derived type has default initialization.

End of Fortran 95

*a* becomes defined with the value determined by *initialization\_expr*, in accordance with the rules for intrinsic assignment. If the entity is an array, its shape must be specified either in the type declaration statement or in a previous specification statement in the same scoping unit. A variable or variable subobject cannot be initialized more than once. If *a* is a variable, the presence of *initialization\_expr* F95 or `NULL()` F95 implies that *a* is a saved object, except for an object in a named common block. The initialization of an object could affect the fundamental storage class of an object.

An *array\_spec* specified in the *entity\_decl* takes precedence over the *array\_spec* in the **DIMENSION** attribute.

An array function result that does not have the **F2003** **ALLOCATABLE** or **F2003** **POINTER** attribute must have an explicit-shape array specification.

If the entity declared is a function, it must not have an accessible explicit interface unless it is an intrinsic function.

IBM Extension

If T or F, defined previously as the name of a constant, appears in a type declaration statement, it is no longer an abbreviated logical constant but the name of the named constant.

End of IBM Extension

## Examples

```
REAL(8), POINTER :: RPTR  
REAL(8), TARGET  :: RTAR
```

## Related information

- “Real” on page 36
- “Initialization expressions” on page 95
- “Determining Type” on page 17, for details on the implicit typing rules
- “Array declarators” on page 73
- “Automatic objects” on page 18
- “Storage classes for variables” on page 26
- “DATA” on page 314, for details on initial values

---

## RECORD

IBM Extension

### Purpose

The **RECORD** statement is a special form of type declaration statement. Unlike other type declaration statements, attributes for entities declared on the **RECORD** statement cannot be specified on the statement itself.

## Syntax

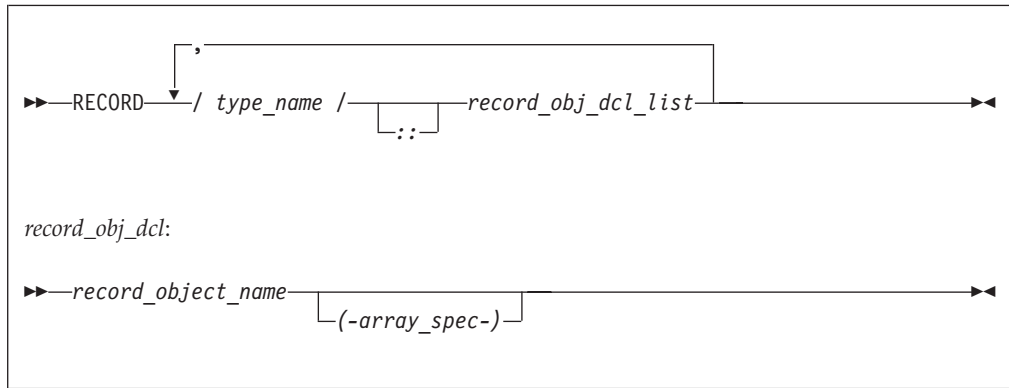

*record\_stmt:*

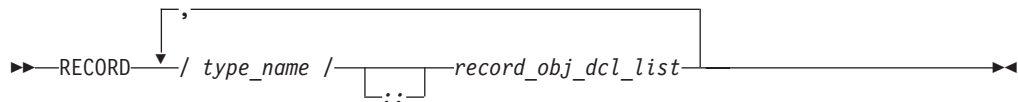

*record\_obj\_dcl:*

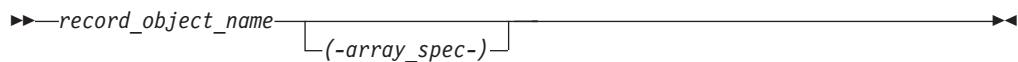

where *type\_name* must be the name of a derived type that is accessible in the scoping unit.

## Rules

Entities can not be initialized in a **RECORD** statement.

A *record\_stmt* declares an entity to be of the derived type, specified by the *type\_name* that most immediately precedes it.

The *RECORD* keyword must not appear as the *type\_spec* of an **IMPLICIT** or **FUNCTION** statement.

A derived type with the **BIND** attribute must not be specified in a **RECORD** statement.

## Examples

In the following example, a **RECORD** statement is used to declare a derived type variable.

```
STRUCTURE /S/  
  INTEGER I  
END STRUCTURE  
STRUCTURE /DT/  
  INTEGER I  
END STRUCTURE  
RECORD/DT/REC1,REC2,/S/REC3,REC4
```

## Related information

- For further information on record structures and derived types, see Chapter 4, “Derived Types,” on page 47

End of IBM Extension

## RETURN

### Purpose

The **RETURN** statement:

- In a function subprogram, ends the execution of the subprogram and returns control to the referencing statement. The value of the function is available to the referencing procedure.
- In a subroutine subprogram, ends the subprogram and transfers control to the first executable statement after the procedure reference or to an alternate return point, if one is specified.

IBM Extension

- In the main program, ends execution of the executable program.

End of IBM Extension

### Syntax

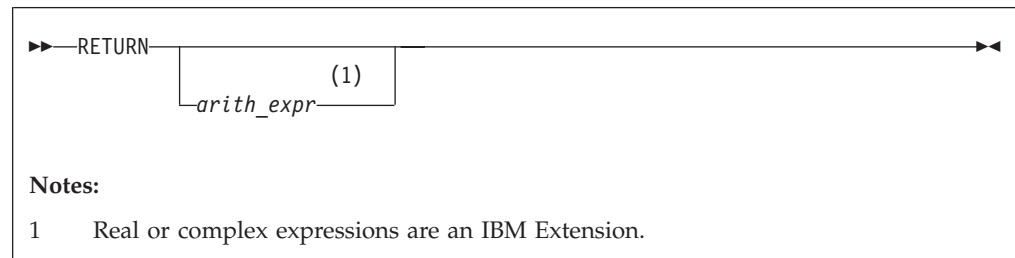

*arith\_expr*

A scalar integer, real, or complex expression. If the value of the expression is noninteger, it is converted to **INTEGER(4)** before use. *arith\_expr* must not be a Hollerith constant.

### Rules

*arith\_expr* can be specified in a subroutine subprogram only, and it specifies an alternate return point. Letting *m* be the value of *arith\_expr*, if  $1 \leq m \leq$  the number of asterisks in the **SUBROUTINE** or **ENTRY** statement, the *m*th asterisk in the dummy argument list is selected. Control then returns to the invoking procedure at the statement whose statement label is specified as the *m*th alternate return specifier in the **CALL** statement. For example, if the value of *m* is 5, control returns to the statement whose statement label is specified as the fifth alternate return specifier in the **CALL** statement.

If *arith\_expr* is omitted or if its value (*m*) is not in the range 1 through the number of asterisks in the **SUBROUTINE** or **ENTRY** statement, a normal return is executed. Control returns to the invoking procedure at the statement following the **CALL** statement.

Executing a **RETURN** statement terminates the association between the dummy arguments of the subprogram and the actual arguments supplied to that instance of the subprogram. All entities local to the subprogram become undefined, except as noted under “Events causing undefinition” on page 23.

A subprogram can contain more than one **RETURN** statement, but it does not require one. An **END** statement in a function or subroutine subprogram has the same effect as a **RETURN** statement.

## Examples

```
CALL SUB(A,B)
CONTAINS
  SUBROUTINE SUB(A,B)
    INTEGER :: A,B
    IF (A.LT.B)
      RETURN           ! Control returns to the calling procedure
    ELSE
      ...
    END IF
  END SUBROUTINE
END
```

## Related information

- “Asterisks as dummy arguments” on page 193
- “Actual argument specification” on page 180 for a description of alternate return points
- “Events causing undefinition” on page 23

---

## REWIND

### Purpose

The **REWIND** statement positions an external file connected for sequential access at the beginning of the first record of the file. F2003 For stream access, the **REWIND** statement positions a file at its initial point. F2003

Fortran 2003

Execution of a **REWIND** statement performs a wait operation for any pending asynchronous data transfer operations for the specified unit.

End of Fortran 2003

### Syntax

```
REWIND u [(position_list)]
```

*u* An external unit identifier that must not be an asterisk or a Hollerith constant.

*position\_list*

A list that must contain one unit specifier ([UNIT=]*u*) and can also contain one of each of the other valid specifiers. The valid specifiers are:

[UNIT=] *u*

A unit specifier in which *u* must be an external unit identifier whose value is not an asterisk. An external unit identifier refers to an external file that is represented by an integer expression, whose value is in the range 1 through 2,147,483,647. If the optional characters **UNIT=** are omitted, *u* must be the first item in *position\_list*.

**ERR=** *stmt\_label*

An error specifier that specifies the statement label of an executable statement in the same scoping unit to which control is to transfer in the case of an error. Coding the **ERR=** specifier suppresses error messages.

---

**Fortran 2003**

---

**IOMSG=** *iormsg\_variable*

An input/output status specifier that specifies the message returned by the input/output operation. *iormsg\_variable* is a scalar default character variable. It must not be a use-associated nonpointer protected variable. When the input/output statement containing this specifier finishes execution, *iormsg\_variable* is defined as follows:

- If an error, end-of-file, or end-of-record condition occurs, the variable is assigned an explanatory message as if by assignment.
- If no such condition occurs, the value of the variable is unchanged.

---

**End of Fortran 2003**

---

**IOSTAT=** *ios*

An input/output status specifier for the status of the input/output operation. *ios* is a scalar integer variable. When the **REWIND** statement finishes executing, *ios* is defined with:

- A zero value if no error condition occurs
- A positive value if an error occurs.

## Rules

If the unit is not connected, an implicit **OPEN** specifying sequential access is performed to a default file named **fort.n**, where *n* is the value of *u* with leading zeros removed. If the external file connected to the specified unit does not exist, the **REWIND** statement has no effect. If it exists, an end-of-file marker is created, if necessary, and the file is positioned at the beginning of the first record. If the file is already positioned at its initial point, the **REWIND** statement has no effect. The **REWIND** statement causes a subsequent **READ** or **WRITE** statement referring to *u* to read data from or write data to the first record of the external file associated with *u*.

If the **ERR=** and **IOSTAT=** specifiers are set and an error is encountered, transfer is made to the statement specified by the **ERR=** specifier and a positive integer value is assigned to *ios*.

IBM Extension

If **IOSTAT=** and **ERR=** are not specified,

- the program stops if a severe error is encountered.
- the program continues to the next statement if a recoverable error is encountered and the **ERR\_RECOVERY** run-time option is set to **YES**. If the option is set to **NO**, the program stops.

End of IBM Extension

## Examples

```
REWIND (9, IOSTAT=IOSS)
```

## Related information

- “Conditions and IOSTAT values” on page 214
- Chapter 9, “XL Fortran Input/Output,” on page 201
- *Setting run-time Options in the XL Fortran Compiler Reference*

---

## SAVE

### Purpose

The **SAVE** attribute specifies the names of objects and named common blocks whose definition status you want to retain after control returns from the subprogram where you define the variables and named common blocks.

### Syntax

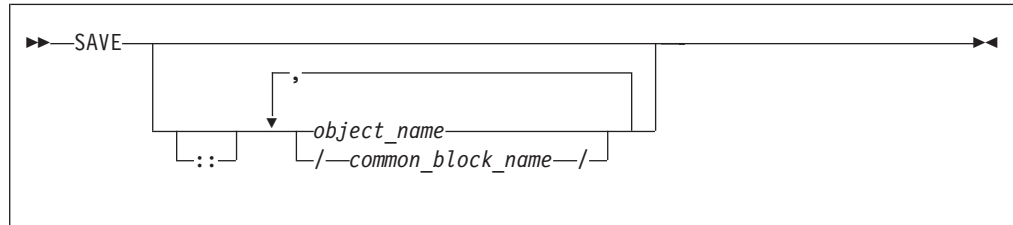

### Rules

A **SAVE** statement without a list is treated as though it contains the names of all common items and local variables in the scoping unit. A common block name having the **SAVE** attribute has the effect of specifying all the entities in that named common block.

Within a function or subroutine subprogram, a variable whose name you specify with the **SAVE** attribute does not become undefined as a result of a **RETURN** or **END** statement in the subprogram.

*object\_name* cannot be the name of a dummy argument, pointee, procedure, automatic object, or common block entity.

If a local entity specified with the **SAVE** attribute (and not in a common block) is in a defined state at the time that a **RETURN** or **END** statement is encountered in a subprogram, that entity is defined with the same value at the next reference of



that subprogram. Saved objects are shared by all instances of the subprogram.

---

**IBM Extension**

---

XL Fortran permits function results to have the **SAVE** attribute. To indicate that a function result is to have the **SAVE** attribute, the function result name must be explicitly specified with the **SAVE** attribute. That is, a **SAVE** statement without a list does not provide the **SAVE** attribute for the function result.

Variables declared as **SAVE** are shared amongst threads. To thread-safe an application that contains shared variables, you must either serialize access to the static data using locks, or make the data thread-specific. One method of making the data thread-specific is to move the static data into a named **COMMON** block that has been declared **THREADLOCAL**. The **Pthreads** library module provides mutexes to allow you to serialize access to the data using locks. See **Pthreads** library module in the *XL Fortran Optimization and Programming Guide* for more information. The *lock\_name* attribute on the **CRITICAL** directive also provides the ability to serialize access to data. See **CRITICAL/END CRITICAL** in the *XL Fortran Optimization and Programming Guide* for more information. The **THREADLOCAL** directive ensures that common blocks are local to each thread. See **THREADLOCAL** in the *XL Fortran Optimization and Programming Guide* for more information.

---

**End of IBM Extension**

---

### Attributes compatible with the SAVE attribute

- ALLOCATABLE
- ASYNCHRONOUS
- DIMENSION
- POINTER
- PRIVATE
- PROTECTED
- PUBLIC
- STATIC
- TARGET
- VOLATILE

## Examples

```
LOGICAL :: CALLED=.FALSE.
CALL SUB(CALLED)
CALLED=.TRUE.
CALL SUB(CALLED)
CONTAINS
  SUBROUTINE SUB(CALLED)
    INTEGER, SAVE :: J
    LOGICAL :: CALLED
    IF (CALLED.EQV..FALSE.) THEN
      J=2
    ELSE
      J=J+1
    ENDIF
    PRINT *, J
  END SUBROUTINE
END
```

! Output on first call is 2  
! Output on second call is 3

## Related information

- “COMMON” on page 303
- **THREADLOCAL** in the *XL Fortran Optimization and Programming Guide*
- “Definition status of variables” on page 19
- “Storage classes for variables” on page 26
- Item 2 under Appendix A, “Compatibility across standards,” on page 815

---

## SELECT CASE

### Purpose

The **SELECT CASE** statement is the first statement of a **CASE** construct. It provides a concise syntax for selecting, at most, one of a number of statement blocks for execution.

### Syntax

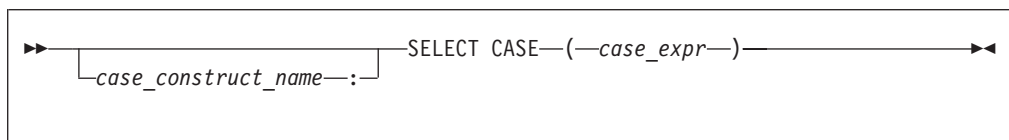

*case\_construct\_name*

A name that identifies the **CASE** construct

*case\_expr*

A scalar expression of type integer, character or logical

## Rules

When a **SELECT CASE** statement is executed, the *case\_expr* is evaluated. The resulting value is called the case index, which is used for evaluating control flow within the case construct.

If the *case\_construct\_name* is specified, it must appear on the **END CASE** statement and optionally on any **CASE** statements within the construct.

### IBM Extension

The *case\_expr* must not be a typeless constant or a **BYTE** data object.

### End of IBM Extension

## Examples

```
ZERO: SELECT CASE(N)           ! start of CASE construct ZERO
      CASE DEFAULT ZERO
      OTHER: SELECT CASE(N) ! start of CASE construct OTHER
      CASE(:-1)
      SIGNUM = -1
      CASE(1:) OTHER
      SIGNUM = 1
      END SELECT OTHER
      CASE (0)
      SIGNUM = 0
END SELECT ZERO
```

## Related information

- “SELECT CASE construct” on page 137
- “CASE” on page 292
- “END (Construct)” on page 336, for details on the **END SELECT** statement

## SELECT TYPE

### Fortran 2003

## Purpose

The **SELECT TYPE** statement is the first statement in a **SELECT TYPE** construct. The construct can have any number of statement blocks, only one of which is selected for execution. The selection is based on the dynamic type of an expression which you specify in the *selector*, and the type of each type guard statement.

## Syntax

```
↳ select_construct_name : SELECT TYPE ( associate_name => selector ) ↳
```

*select\_construct\_name*

A name that identifies the **SELECT TYPE** construct.

*associate\_name*

A name that is associated with the *selector* when executing the **SELECT TYPE** statement.

*selector* An expression, evaluated when executing the **SELECT TYPE** statement. The result must be polymorphic.

## Rules

If the *selector* is not a named variable, *associate\_name* must appear. If the *selector* is not a definable variable or is a variable that has a vector subscript, *associate\_name* must not appear in a variable definition context.

The selector must be polymorphic.

If the *select\_construct\_name* is specified, it must appear on the **END SELECT** statement and optionally on any type guard statements within the construct.

## Related information

- “SELECT TYPE construct” on page 139
- “Type Guard” on page 467
- “END (Construct)” on page 336, for details on the **END SELECT** statement

End of Fortran 2003

---

## SEQUENCE

### Purpose

The **SEQUENCE** statement specifies that the order of the components in a derived-type definition establishes the storage sequence for objects of that type. Such a type becomes a *sequence derived type*.

### Syntax

▶▶—SEQUENCE—▶▶

### Rules

The **SEQUENCE** statement can be specified only once in a derived-type definition.

If a component of a sequence derived type is of derived type, that derived type must also be a sequence derived type.

IBM Extension

The size of a sequence derived type is equal to the number of bytes of storage needed to hold all of the components of that derived type.

End of IBM Extension

Use of sequence derived types can lead to misaligned data, which can adversely affect the performance of a program.

If a derived type definition has procedures or the **BIND** attribute, the **SEQUENCE** statement cannot be specified. Also, **SEQUENCE** cannot be specified for an extended type.

## Examples

```

TYPE PERSON
  SEQUENCE
  CHARACTER*1 GENDER      ! Offset 0
  INTEGER(4) AGE          ! Offset 1
  CHARACTER(30) NAME      ! Offset 5
END TYPE PERSON

```

## Related information

- Chapter 4, “Derived Types,” on page 47
- “Derived Type” on page 320
- “END TYPE” on page 341

---

## Statement Function

### Purpose

A statement function defines a function in a single statement.

### Syntax

```

▶▶ name ( dummy_argument_list ) = scalar_expression ▶▶

```

*name* is the name of the statement function. It must not be supplied as a procedure argument and cannot be the target of a procedure pointer.

*dummy\_argument*

can only appear once in the dummy argument list of any statement function. The dummy arguments have the scope of the statement function statement, and the same types and type parameters as the entities of the same names in the scoping unit containing the statement function.

### Rules

A statement function is local to the scoping unit in which it is defined. It must not be defined in the scope of a module.

*name* determines the data type of the value returned from the statement function. If the data type of *name* does not match that of the scalar expression, the value of the scalar expression is converted to the type of *name* in accordance with the rules for assignment statements.

The names of the function and all the dummy arguments must be specified, explicitly or implicitly, to be scalar data objects.

The scalar expression can be composed of constants, references to variables, references to functions and function dummy procedures, and intrinsic operations. If the expression contains a reference to a function or function dummy procedure, the reference must not require an explicit interface, the function must not require an explicit interface or be a transformational intrinsic, and the result must be scalar. If an argument to a function or function dummy procedure is array-valued, it must be an array name.

#### IBM Extension

With XL Fortran, the scalar expression can also reference a structure constructor.

#### End of IBM Extension

The scalar expression can reference another statement function that is either:

- Declared previously in the same scoping unit, or
- Declared in the host scoping unit.

Named constants and arrays whose elements are referenced in the expression must be declared earlier in the scoping unit or be made accessible by use or host association.

Variables that are referenced in the expression must be either:

- Dummy arguments of the statement function, or
- Accessible in the scoping unit

If an entity in the expression is typed by the implicit typing rules, its type must agree with the type and type parameters given in any subsequent type declaration statement.

An external function reference in the scalar expression must not cause any dummy arguments of the statement function to become undefined or redefined.

If the statement function is defined in an internal subprogram and if it has the same name as an accessible entity from the host, precede the statement function definition with an explicit declaration of the statement function name. For example, use a type declaration statement.

The length specification for a statement function of type character or a statement function dummy argument of type character must be a constant specification expression.

## Examples

```
PARAMETER (PI = 3.14159)
REAL AREA,CIRCUM,R,RADIUS
AREA(R) = PI * (R**2)           ! Define statement functions
CIRCUM(R) = 2 * PI * R         ! AREA and CIRCUM

! Reference the statement functions
PRINT *, 'The area is: ', AREA(RADIUS)
PRINT *, 'The circumference is: ', CIRCUM(RADIUS)
```

## Related information

- “Dummy arguments” on page 182
- “Function reference” on page 177

- “Determining Type” on page 17, for information on how the type of the statement function is determined

## STATIC

### IBM Extension

### Purpose

The **STATIC** attribute specifies that a variable has a storage class of static; that is, the variable remains in memory for the duration of the program and its value is retained between calls to the procedure.

### Syntax

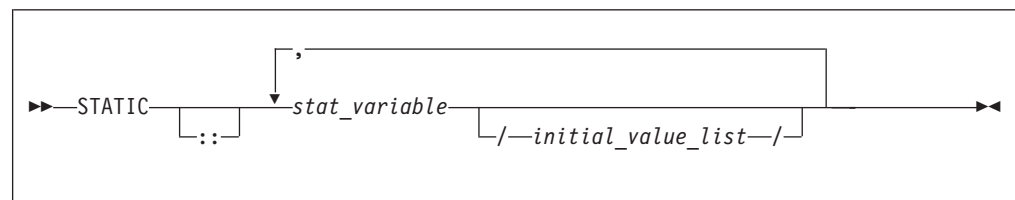

*stat\_variable*

is a variable name or an array declarator that can specify an *explicit\_shape\_spec\_list* or a *deferred\_shape\_spec\_list*.

*initial\_value*

provides an initial value for the variable specified by the immediately preceding name. Initialization occurs as described in “DATA” on page 314.

### Rules

If *stat\_variable* is a result variable, it must not be of type character or of derived type. Dummy arguments, automatic objects and pointees must not have the **STATIC** attribute. A variable that is explicitly declared with the **STATIC** attribute cannot be a common block item.

A variable must not have the **STATIC** attribute specified more than once in the same scoping unit.

Local variables have a default storage class of automatic. See the **-qsave** option in the *XL Fortran Compiler Reference* for details on the default settings with regard to the invocation commands.

Variables declared as **STATIC** are shared amongst threads. To thread-safe an application that contains shared variables, you must either serialize access to the static data using locks, or make the data thread-specific. One method of making the data thread-specific is to move the static data into a **COMMON** block that has been declared **THREADLOCAL**. The **Pthreads** library module provides mutexes to allow you to serialize access to the data using locks. See Pthreads library module in the *XL Fortran Optimization and Programming Guide* for more information. The *lock\_name* attribute on the **CRITICAL/END CRITICAL** in the *XL Fortran Optimization and Programming Guide* for more information. The **THREADLOCAL** directive ensures that common blocks are local to each thread. See **THREADLOCAL** in the *XL Fortran Optimization and Programming Guide* for more information.

### Attributes compatible with the **STATIC** attribute

- ALLOCATABLE
- ASYNCHRONOUS
- DIMENSION
- POINTER
- PRIVATE
- PROTECTED
- SAVE
- TARGET
- VOLATILE

## Examples

```
LOGICAL :: CALLED=.FALSE.
CALL SUB(CALLED)
CALLED=.TRUE.
CALL SUB(CALLED)
CONTAINS
  SUBROUTINE SUB(CALLED)
    INTEGER, STATIC :: J
    LOGICAL :: CALLED
    IF (CALLED.EQV..FALSE.) THEN
      J=2
    ELSE
      J=J+1
    ENDIF
    PRINT *, J
  END SUBROUTINE
END
```

! Output on first call is 2  
! Output on second call is 3

## Related information

- “Storage classes for variables” on page 26
- “COMMON” on page 303
- **THREADLOCAL** in the *XL Fortran Optimization and Programming Guide*

End of IBM Extension

---

## STOP

### Purpose

When the **STOP** statement is executed, the program stops executing and, if a character constant or digit string is specified, prints the keyword **STOP** followed by the constant or digit string to unit 0.

### Syntax

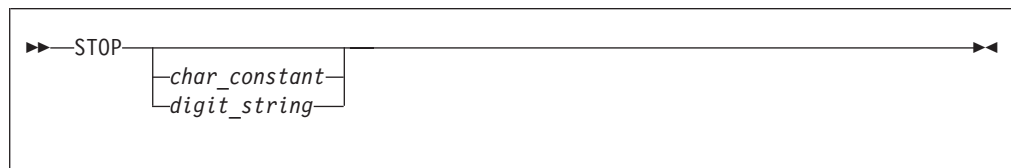

*char\_constant*

is a scalar character constant that is not a Hollerith constant



*digit\_string*  
is a string of one through five digits

## Rules

### IBM Extension

If neither *char\_constant* nor *digit\_string* are specified, nothing is printed to standard error (unit 0).

If you specify *digit\_string*, XL Fortran sets the system return code to **MOD** (*digit\_string*,256). The system return code is available in the Korn shell command variable \$?.

### End of IBM Extension

A **STOP** statement cannot terminate the range of a **DO** or **DO WHILE** construct.

### Fortran 2003

If you compile your application with **-qxlf2003=stopexcept**, informational messages are displayed when IEEE floating-point exceptions are signalled by a **STOP** statement.

### End of Fortran 2003

## Examples

```
STOP 'Abnormal Termination'    ! Output: STOP Abnormal Termination
END

STOP                             ! No output
END
```

---

## SUBROUTINE

### Purpose

The **SUBROUTINE** statement is the first statement of a subroutine subprogram.

### Syntax

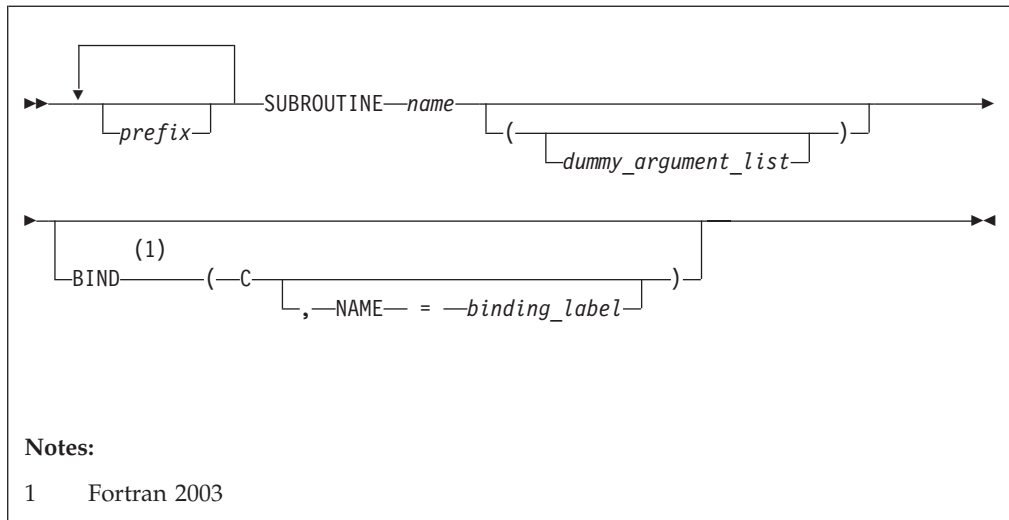

*prefix* is one of the following:

- F95 ELEMENTAL  F95
- F95 PURE  F95
- RECURSIVE

**Note:** *type\_spec* is not permitted as a prefix in a subroutine.

*name* The name of the subroutine subprogram.

Fortran 2003

*binding\_label*

A scalar character initialization expression.

End of Fortran 2003

## Rules

At most one of each kind of *prefix* can be specified.

The subroutine name cannot appear in any other statement in the scope of the subroutine, unless recursion has been specified.

The **RECURSIVE** keyword must be specified if, directly or indirectly,

- The subroutine invokes itself.
- The subroutine invokes a procedure defined by an **ENTRY** statement in the same subprogram.
- An entry procedure in the same subprogram invokes itself.
- An entry procedure in the same subprogram invokes another entry procedure in the same subprogram.
- An entry procedure in the same subprogram invokes the subprogram defined by the **SUBROUTINE** statement.

If the **RECURSIVE** keyword is specified, the procedure interface is explicit within the subprogram.

### Fortran 95

Using the **PURE** or **ELEMENTAL** prefix indicates that the subroutine may be invoked by the compiler in any order as it is free of side effects. For elemental procedures, the keyword **ELEMENTAL** must be specified. If the **ELEMENTAL** keyword is specified, the **RECURSIVE** keyword cannot be specified.

End of Fortran 95

### IBM Extension

You can also call external procedures recursively when you specify the **-qrecur** compiler option, although XL Fortran disregards this option if the **SUBROUTINE** statement specifies the **RECURSIVE** keyword.

End of IBM Extension

### Fortran 2003

The **BIND** keyword implicitly or explicitly defines a binding label by which a procedure is accessed from the C programming language. A dummy argument cannot be zero-sized. A dummy argument for a procedure with the **BIND** attribute must have interoperable types and type parameters, and cannot have the **ALLOCATABLE**, **OPTIONAL**, or **POINTER** attribute.

The **BIND** attribute must not be specified for an internal procedure. If the **SUBROUTINE** statement appears as part of an interface body that describes a dummy procedure, the **NAME=** specifier must not appear. An elemental procedure cannot have the **BIND** attribute.

End of Fortran 2003

## Examples

```
RECURSIVE SUBROUTINE SUB(X,Y)
  INTEGER X,Y
  IF (X.LT.Y) THEN
    RETURN
  ELSE
    CALL SUB(X,Y+1)
  END IF
END SUBROUTINE SUB
```

## Related information

- “Function and subroutine subprograms” on page 175
- “Dummy arguments” on page 182
- “Recursion” on page 195
- “CALL” on page 290
- “ENTRY” on page 343
- “Statement Function” on page 449
- “BIND” on page 285
- “RETURN” on page 441
- “Definition status of variables” on page 19
- “Pure procedures” on page 196
- **-qrecur** option in the *XL Fortran Compiler Reference*

# TARGET

## Purpose

The **TARGET** statement specifies the **TARGET** attribute of an entity. An object with the **TARGET** attribute may have a pointer associated with it.

## Syntax

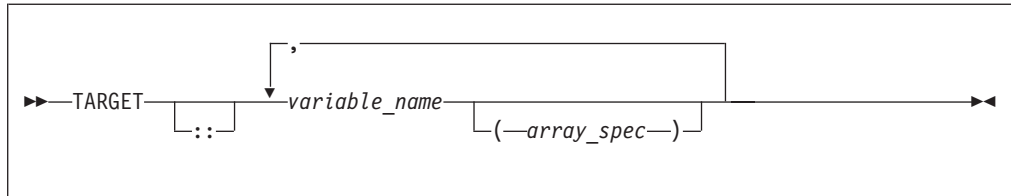

## Rules

If a data object has the **TARGET** attribute, then all of the data object's nonpointer subobjects will also have the **TARGET** attribute.

A data object that does not have the **TARGET** attribute cannot be associated with an accessible pointer.

A target cannot appear in an **EQUIVALENCE** statement.

### IBM Extension

A target cannot be an integer pointer or a pointee.

### End of IBM Extension

### Attributes compatible with the TARGET attribute

- ALLOCATABLE
- ASYNCHRONOUS
- AUTOMATIC
- DIMENSION
- INTENT
- OPTIONAL
- PRIVATE
- PROTECTED
- PUBLIC
- SAVE
- STATIC
- VALUE
- VOLATILE

## Examples

```

REAL, POINTER :: A,B
REAL, TARGET :: C = 3.14
B => C
A => B      ! A points to C

```

## Related information

- "POINTER (Fortran 90)" on page 410
- "ALLOCATED(X)" on page 541
- "DEALLOCATE" on page 318
- "Data pointer assignment" on page 123
- "Pointer association" on page 152

# TYPE

## Purpose

A **TYPE** type declaration statement specifies the type and attributes of objects and functions of derived type. Initial values can be assigned to objects.

## Syntax

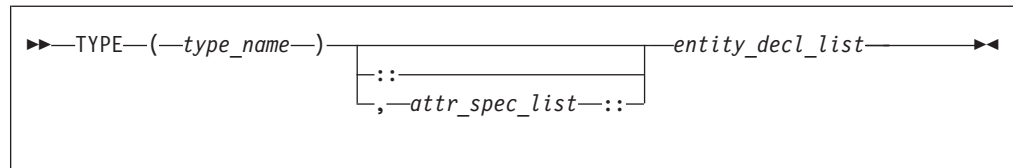

where:

<i>attr_spec</i>
<b>ALLOCATABLE</b>
<b>ASYNCHRONOUS</b>
<b>AUTOMATIC</b>
<b>BIND</b>
<b>DIMENSION</b> ( <i>array_spec</i> )
<b>EXTERNAL</b>
<b>INTENT</b> ( <i>intent_spec</i> )
<b>INTRINSIC</b>
<b>OPTIONAL</b>
<b>PARAMETER</b>
<b>POINTER</b>
<b>PRIVATE</b>
<b>PROTECTED</b>
<b>PUBLIC</b>
<b>SAVE</b>
<b>STATIC</b>
<b>TARGET</b>
<b>VALUE</b>
<b>VOLATILE</b>

*type\_name*

is the name of a derived type.

Fortran 2003

The derived type must not be abstract.

End of Fortran 2003

*attr\_spec*

For detailed information on rules about a particular attribute, refer to the statement of the same name.

*intent\_spec*

is either **IN**, **OUT**, or **INOUT**

**::** is the double colon separator. It is required if attributes are specified, = *initialization\_expr* is used, **F95** or =>**NULL0** **F95** appears as part of any *entity\_decl*.

*array\_spec*  
is a list of dimension bounds

*entity\_decl*

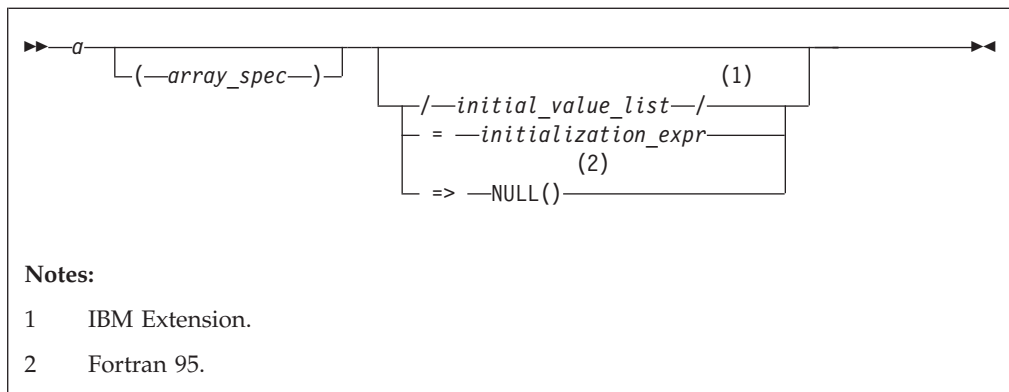

*a* is an object name or function name. *array\_spec* cannot be specified for a function with an implicit interface.

**IBM Extension**

*initial\_value*  
provides an initial value for the entity specified by the immediately preceding name. Initialization occurs as described in “DATA” on page 314.

**End of IBM Extension**

*initialization\_expr*  
provides an initial value, by means of an initialization expression, for the entity specified by the immediately preceding name

**Fortran 95**

**=> NULL()**  
provides the initial value for a pointer object

**End of Fortran 95**

## Rules

**Fortran 95**

Within the context of a derived type definition:

- If => appears in a component initialization, the **POINTER** attribute must appear in the *attr\_spec\_list*.
- If = appears in a component initialization, the **POINTER** attribute cannot appear in the component *attr\_spec\_list*.
- The compiler will evaluate *initialization\_expr* within the scoping unit of the type definition.

If => appears for a variable, the object must have the **POINTER** attribute.

**End of Fortran 95**

If *initialization\_expr* appears for a variable, the object cannot have the **POINTER** attribute.

Entities in type declaration statements are constrained by the rules of any attributes specified for the entities, as detailed in the corresponding attribute statements.

Once a derived type has been defined, you can use it to define your data items using the **TYPE** type declaration statement. When an entity is explicitly declared to be of a derived type, that derived type must have been previously defined in the scoping unit or is accessible by use or host association.

The data object becomes an *object of derived type* or a *structure*. Each *structure component* is a subobject of the object of derived type.



If you specify the **DIMENSION** attribute, you are creating an array whose elements have a data type of that derived type.

Other than in specification statements, you can use objects of derived type as actual and dummy arguments, and they can also appear as items in input/output lists (unless the object has a component with the **POINTER** attribute), assignment statements, structure constructors, and the right side of a statement function definition. If a structure component is not accessible, a derived-type object cannot be used in an input/output list or as a structure constructor.

Objects of nonsequence derived type cannot be used as data items in **EQUIVALENCE** and **COMMON** statements. Objects of nonsequence data types cannot be integer pointees.

A nonsequence derived-type dummy argument must specify a derived type that is accessible through use or host association to ensure that the same derived-type definition defines both the actual and dummy arguments.

The type declaration statement overrides the implicit type rules in effect.

An object cannot be initialized in a type declaration statement if it is a dummy argument, allocatable object, function result, object in a blank common block, integer pointer, external name, intrinsic name, or automatic object. Nor can an object be initialized if it has the **AUTOMATIC** attribute. The object may be initialized if it appears in a named common block in a block data program unit  or if it appears in a named common block in a module. 

#### Fortran 95

In Fortran 95, a pointer can be initialized. Pointers can only be initialized by the use of **=> NULL()**.

#### End of Fortran 95

The specification expression of an *array\_spec* can be a nonconstant expression if the specification expression appears in an interface body or in the specification part of a subprogram. Any object being declared that uses this nonconstant expression and is not a dummy argument or a pointee is called an *automatic object*.

An attribute cannot be repeated in a given type declaration statement, nor can an entity be explicitly given the same attribute more than once in a scoping unit.

*initialization\_expr* must be specified if the statement contains the **PARAMETER** attribute. If the entity you are declaring is a variable, and *initialization\_expr* **F95** or **NULL()** **F95** is specified, the variable is initially defined.

---

**Fortran 95**

---

If the entity you are declaring is a derived type component, and *initialization\_expr* or **NULL()** is specified, the derived type has default initialization.

---

**End of Fortran 95**

---

*a* becomes defined with the value determined by *initialization\_expr*, in accordance with the rules for intrinsic assignment. If the entity is an array, its shape must be specified either in the type declaration statement or in a previous specification statement in the same scoping unit. A variable or variable subobject cannot be initialized more than once. If *a* is a variable, the presence of *initialization\_expr* **F95** or **NULL()** **F95** implies that *a* is a saved object, except for an object in a named common block. The initialization of an object could affect the fundamental storage class of an object.

An *array\_spec* specified in the *entity\_decl* takes precedence over the *array\_spec* in the **DIMENSION** attribute.

An array function result that does not have the **ALLOCATABLE** or **POINTER** attribute must have an explicit-shape array specification.

If the entity declared is a function, it must not have an accessible explicit interface unless it is an intrinsic function. The derived type can be specified on the **FUNCTION** statement, provided the derived type is defined within the body of the function or is accessible via host or use association.

---

**IBM Extension**

---

If **T** or **F**, defined previously as the name of a constant, appears in a type declaration statement, it is no longer an abbreviated logical constant but the name of the named constant.

---

**End of IBM Extension**

---

## Examples

```
TYPE PEOPLE                                ! Defining derived type PEOPLE
  INTEGER AGE
  CHARACTER*20 NAME
END TYPE PEOPLE
TYPE(PEOPLE) :: SMITH = PEOPLE(25,'John Smith')
END
```

## Related information

- Chapter 4, “Derived Types,” on page 47
- “Derived Type” on page 320
- “Initialization expressions” on page 95
- “Determining Type” on page 17, for details on the implicit typing rules
- “Array declarators” on page 73
- “Automatic objects” on page 18





*attr\_spec*

is any of the following:

<b>ALLOCATABLE</b>	<b>INTRINSIC</b>	<b>PUBLIC</b>
<b>ASYNCHRONOUS</b>	<b>OPTIONAL</b>	<b>SAVE</b>
<b>AUTOMATIC</b>	<b>PARAMETER</b>	<b>STATIC</b>
<b>BIND</b> (C[, NAME= <i>binding_label</i> ])	<b>POINTER</b>	<b>TARGET</b>
<b>DIMENSION</b> ( <i>array_spec</i> )	<b>PRIVATE</b>	<b>VALUE</b>
<b>EXTERNAL</b>	<b>PROTECTED</b>	<b>VOLATILE</b>
<b>INTENT</b> ( <i>intent_spec</i> )		

*kind\_selector*

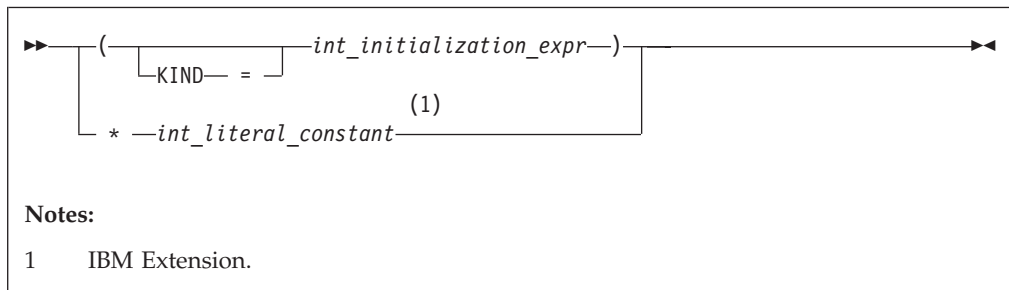

represents one of the permissible length specifications for its associated type.

**IBM Extension**

*int\_literal\_constant* cannot specify a kind type parameter.

**End of IBM Extension**

*type\_spec*

must specify **PIXEL**, **REAL** of kind 4, or **INTEGER** or **UNSIGNED** of kind 1, 2, or 4.

*char\_selector*

specifies the character length

**IBM Extension**

In XL Fortran, this is the number of characters between 0 and 256 MB. Values exceeding 256 MB are set to 256 MB, while negative values result in a length of zero. If not specified, the default length is 1. The kind type parameter, if specified, must be 1, which specifies the ASCII character representation.

**End of IBM Extension**

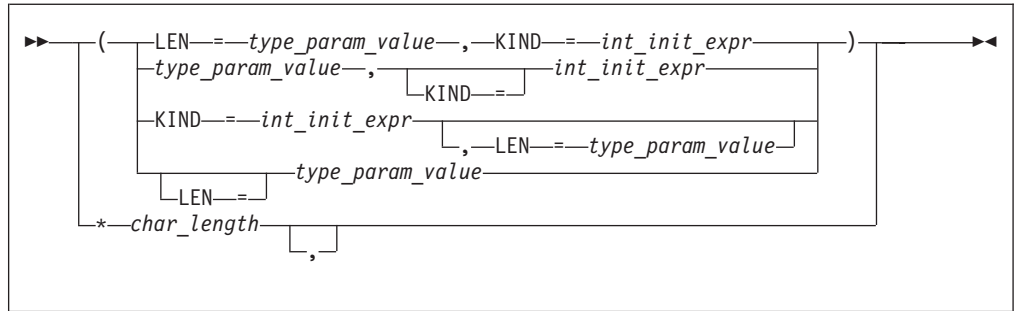

*type\_param\_value*

is a specification expression or an asterisk (\*)

*int\_init\_expr*

is a scalar integer initialization expression that must evaluate to 1

*char\_length*

is either a scalar integer literal constant (which cannot specify a kind type parameter) or a *type\_param\_value* enclosed in parentheses

*attr\_spec*

For detailed information on rules about a particular attribute, refer to the statement of the same name.

*intent\_spec*

is either **IN**, **OUT**, or **INOUT**

:: is the double colon separator. Use the double colon separator when you specify attributes, =*initialization\_expr*, **F95** or => **NULL()** **F95**.

*array\_spec*

is a list of dimension bounds.

*entity\_decl*

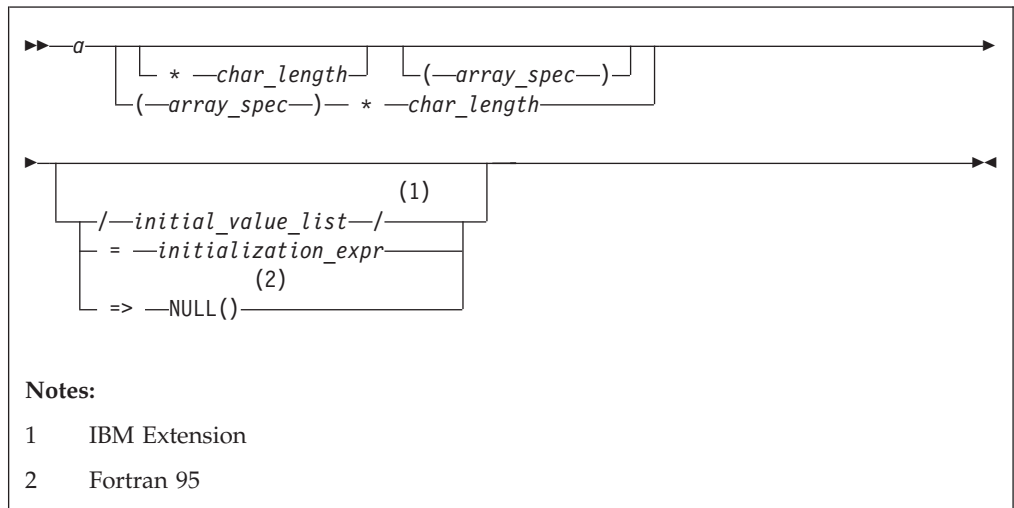

*a* is an object name or function name. *array\_spec* cannot be specified

for a function with an implicit interface.

————— **IBM Extension** —————

*char\_length*

overrides the length as specified in *kind\_selector* and *char\_selector*, and is only permitted in statements where the length can be specified with the initial keyword. A character entity can specify *char\_length*, as defined above. A noncharacter entity can only specify an integer literal constant that represents one of the permissible length specifications for its associated type.

————— **End of IBM Extension** —————

————— **IBM Extension** —————

*initial\_value*

provides an initial value for the entity specified by the immediately preceding name.

————— **End of IBM Extension** —————

*initialization\_expr*

provides an initial value, by mean of an initialization expression, for the entity specified by the immediately preceding name.

————— **Fortran 95** —————

=> **NULL()**

provides the initial value for the pointer object.

————— **End of Fortran 95** —————

## Rules

————— **Fortran 95** —————

Within the context of a derived type definition:

- If => appears in a component initialization, the **POINTER** attribute must appear in the *attr\_spec\_list*.
- If = appears in a component initialization, the **POINTER** attribute cannot appear in the component *attr\_spec\_list*.
- The compiler will evaluate *initialization\_expr* within the scoping unit of the type definition.



If => appears for a variable, the object must have the **POINTER** attribute.

————— **End of Fortran 95** —————

If *initialization\_expr* appears for a variable, the object cannot have the **POINTER** attribute.

Entities in type declaration statements are constrained by the rules of any attributes specified for the entities, as detailed in the corresponding attribute statements.

The type declaration statement overrides the implicit type rules in effect. You can use a type declaration statement that confirms the type of an intrinsic function. The appearance of a generic or specific intrinsic function name in a type declaration statement does not cause the name to lose its intrinsic property.

An object cannot be initialized in a type declaration statement if it is a dummy argument, allocatable object, function result, object in a blank common block, integer pointer, external name, intrinsic name, or automatic object. Nor can an object be initialized if it has the **AUTOMATIC** attribute. The object may be initialized if it appears in a named common block in a block data program unit  or if it appears in a named common block in a module. 

---

**Fortran 95**

---

In Fortran 95, a pointer can be initialized. Pointers can only be initialized by the use of `=> NULL()`.



---

**End of Fortran 95**

---

The specification expression of a *type\_param\_value* or an *array\_spec* can be a nonconstant expression if the specification expression appears in an interface body or in the specification part of a subprogram. Any object being declared that uses this nonconstant expression and is not a dummy argument or a pointee is called an *automatic object*.

An attribute cannot be repeated in a given type declaration statement, nor can an entity be explicitly given the same attribute more than once in a scoping unit.

*initialization\_expr* must be specified if the statement contains the **PARAMETER** attribute. If the entity you are declaring is a variable, and *initialization\_expr*  or `NULL()`  is specified, the variable is initially defined.

---

**Fortran 95**



---

If the entity you are declaring is a derived type component, and *initialization\_expr* or `NULL()` is specified, the derived type has default initialization.



---

**End of Fortran 95**

---

*a* becomes defined with the value determined by *initialization\_expr*, in accordance with the rules for intrinsic assignment. If the entity is an array, its shape must be specified either in the type declaration statement or in a previous specification statement in the same scoping unit. A variable or variable subobject cannot be initialized more than once. If *a* is a variable, the presence of *initialization\_expr*  or `NULL()`  implies that *a* is a saved object, except for an object in a named common block. The initialization of an object could affect the fundamental storage class of an object.

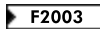
An *array\_spec* specified in an *entity\_decl* takes precedence over the *array\_spec* in the **DIMENSION** attribute.

An array function result that does not have the  **ALLOCATABLE** or  **POINTER** attribute must have an explicit-shape array specification.

If the entity declared is a function, it must not have an accessible explicit interface unless it is an intrinsic function.

### IBM Extension

If T or F, defined previously as the name of a constant, appears in a type declaration statement, it is no longer an abbreviated logical constant but the name of the named constant.

### End of IBM Extension

The optional comma after *char\_length* in a **CHARACTER** type declaration statement is permitted only if no double colon separator (::) appears in the statement.

### Fortran 2003

If the **CHARACTER** type declaration statement specifies a length of a colon, the length type parameter is a *deferred type parameter*. An entity or component with a deferred type parameter must specify the **ALLOCATABLE** or **POINTER** attribute. A deferred type parameter is a length type parameter whose value can change during the execution of the program.

### End of Fortran 2003

If the **CHARACTER** type declaration statement is in the scope of a module, block data program unit, or main program, and you specify the length of the entity as an inherited length, the entity must be the name of a named character constant. The character constant assumes the length of its corresponding expression defined by the **PARAMETER** attribute.

If the **CHARACTER** type declaration statement is in the scope of a procedure and the length of the entity is inherited, the entity name must be the name of a dummy argument or a named character constant. If the statement is in the scope of an external function, it can also be the function or entry name in a **FUNCTION** or **ENTRY** statement in the same program unit. If the entity name is the name of a dummy argument, the dummy argument assumes the length of the associated actual argument for each reference to the procedure. If the entity name is the name of a character constant, the character constant assumes the length of its corresponding expression defined by the **PARAMETER** attribute. If the entity name is a function or entry name, the entity assumes the length specified in the calling scoping unit.

The length of a character function can be a specification expression (which must be a constant expression if the function type is not declared in an interface block) or it is a colon, or an asterisk, indicating the length of a dummy procedure name. The length cannot be an asterisk if the function is an internal or module function, if it is recursive, or if it returns array or pointer values.

## Examples

```
CHARACTER(KIND=1,LEN=6) APPLES /'APPLES'/  
CHARACTER*7, TARGET :: ORANGES = 'ORANGES'  
CALL TEST(APPLES)  
END
```

```
SUBROUTINE TEST(VARBL)  
  CHARACTER*(*), OPTIONAL :: VARBL ! VARBL inherits a length of 6  
  
  COMPLEX, DIMENSION (2,3) :: ABC(3) ! ABC has 3 (not 6) array elements  
  REAL, POINTER :: XCONST
```

```

TYPE PEOPLE                                ! Defining derived type PEOPLE
  INTEGER AGE
  CHARACTER*20 NAME
END TYPE PEOPLE
TYPE(PEOPLE) :: SMITH = PEOPLE(25,'John Smith')
END

```

## Related information

- “Initialization expressions” on page 95
- “Determining Type” on page 17, for details on the implicit typing rules
- “Array declarators” on page 73
- “Automatic objects” on page 18
- “Storage classes for variables” on page 26
- “DATA” on page 314, for details on initial values
- “Polymorphic entities” on page 18
- “CLASS” on page 299

---

## Type Guard

Fortran 2003

### Purpose

A type guard statement initiates a type guard statement block in a **SELECT TYPE** construct. A **SELECT TYPE** construct can have any number of statement blocks, only one of which is selected for execution. The selection is based on the dynamic type of an expression — the *selector* — in a **SELECT TYPE** statement, and the type of each type guard statement.

### Syntax

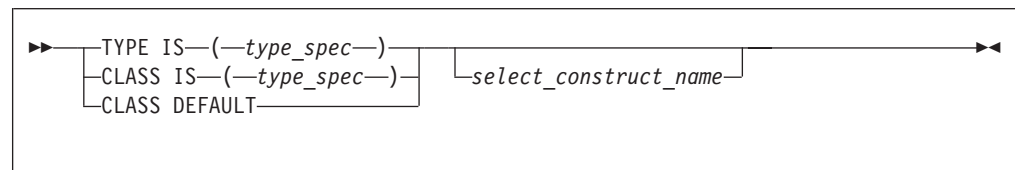

*type\_spec*

must be an extensible or intrinsic type. The length type parameter on character types must be assumed.

*select\_construct\_name*

is a name that identifies the **SELECT TYPE** construct

### Rules

If the selector of the **SELECT TYPE** statement is not unlimited polymorphic, the *type\_spec* must specify an extension of the declared type of the selector.

For a single **SELECT TYPE** construct, the same type and kind type parameter values must not be specified in more than one **TYPE IS** type guard statement and must not be specified in more than one **CLASS IS** type guard statement.

The **CLASS DEFAULT** type guard statement can only occur once in a **SELECT TYPE** construct.

If the *select\_construct\_name* is specified, it must match the name specified on the **SELECT TYPE** and **END SELECT** statements.

**Related information**

- “SELECT TYPE construct” on page 139
- “SELECT TYPE” on page 447
- “END (Construct)” on page 336, for details on the **END SELECT** statement

End of Fortran 2003

# USE

## Purpose

The **USE** statement is a module reference that provides local access to the public entities of a module.

## Syntax

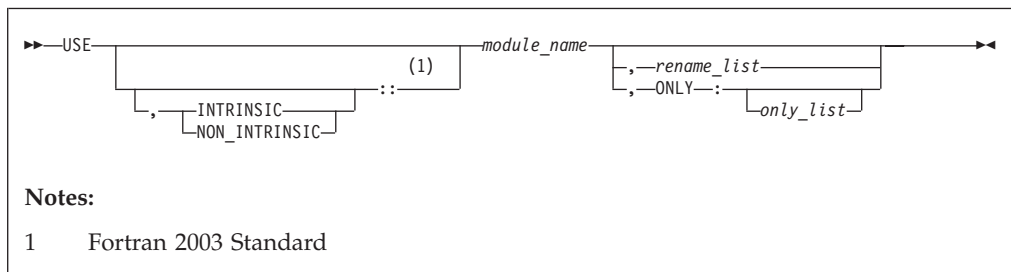

*rename* is

- the assignment of a local name to an accessible data entity: *local-name* => *use-name*

Fortran 2003

- renaming a use-defined operator to a local-defined operator:  
`OPERATOR(local-defined-operator) => OPERATOR(use-defined-operator)`

End of Fortran 2003

*only* is a *rename*, a generic specification, or the name of a variable, procedure, derived type, named constant, or namelist group

## Rules

The **USE** statement can only appear prior to all other statements in *specification\_part*. Multiple **USE** statements may appear within a scoping unit.

IBM Extension

At the time the file containing the **USE** statement is being compiled, the specified module must precede the **USE** statement in the file or the module must have been already compiled in another file. Each referenced entity must be the name of a



public entity in the module.

End of IBM Extension

Entities in the scoping unit become *use-associated* with the module entities, and the local entities have the attributes of the corresponding module entities.

Fortran 2003

By default, either an intrinsic module or a non-intrinsic module with the specified name is accessed. If both an intrinsic module and a non-intrinsic module have this name, the non-intrinsic module is accessed. If you specify **INTRINSIC** or **NON\_INTRINSIC**, only an intrinsic module or only a non-intrinsic module can be accessed.

When you rename an operator in a *rename-list* or an *only-list*, the *use-defined-operator* is identified by the *local-defined-operator* for the scoping unit that contains the **USE** statement. That operator must be a public entity that is not a generic binding within the module you specify in the **USE** statement.

End of Fortran 2003

In addition to the **PRIVATE** attribute, the **ONLY** clause of the **USE** statement provides further constraint on which module entities can be accessed. If the **ONLY** clause is specified, only entities named in the *only\_list* are accessible. If no list follows the keyword, no module entities are accessible. If the **ONLY** clause is absent, all public entities are accessible.

If a scoping unit contains multiple **USE** statements, all specifying the same module, and one of the statements does not include the **ONLY** clause, all public entities are accessible. If each **USE** statement includes the **ONLY** clause, only those entities named in one or more of the *only\_lists* are accessible.

You can rename an accessible entity for local use. A module entity can be accessed by more than one local name. If no renaming is specified, the name of the use-associated entity becomes the local name. The local name of a use-associated entity cannot be redeclared. However, if the **USE** statement appears in the scoping unit of a module, the local name can appear in a **PUBLIC** or **PRIVATE** statement.

If multiple generic interfaces that are accessible to a scoping unit have the same local name, operator, or assignment, they are treated as a single generic interface. In such a case, one of the generic interfaces can contain an interface body to an accessible procedure with the same name. Otherwise, any two different use-associated entities can only have the same name if the name is not used to refer to an entity in the scoping unit. If a use-associated entity and host entity share the same name, the host entity becomes inaccessible through host association by that name.

The accessed entities have the attributes specified in the module, except that an entity may have a different accessibility attribute or it can have the **VOLATILE** attribute in the local scoping unit even if the associated module entity does not.

A module must not reference itself, either directly or indirectly. For example, module X cannot reference module Y if module Y references module X.

Consider the situation where a module (for example, module B) has access through use association to the public entities of another module (for example, module A). The accessibility of module B's local entities (which includes those entities that are use-associated with entities from module A) to other program units is determined by the **PRIVATE** and **PUBLIC** attributes, or, if absent, through the default accessibility of module B. Of course, other program units can access the public entities of module A directly.

## Examples

```

MODULE A
  REAL :: X=5.0
END MODULE A
MODULE B
  USE A
  PRIVATE :: X           ! X cannot be accessed through module B
  REAL :: C=80, D=50
END MODULE B
PROGRAM TEST
  INTEGER :: TX=7
  CALL SUB
CONTAINS

  SUBROUTINE SUB
  USE B, ONLY : C
  USE B, T1 => C
  USE B, TX => C         ! C is given another local name
  USE A
  PRINT *, TX           ! Value written is 80 because use-associated
                       ! entity overrides host entity
  END SUBROUTINE
END

```

---

### Fortran 2003

---

Example: Renaming a defined operator

```

module temp
  type real_num
  real :: x
  end type

  interface operator (.add.)
  module procedure real_add
  end interface

  contains
  function real_add(a,b)
  type(real_num) :: real_add
  type(real_num), intent(in) :: a,b
  real_add%x = a%x+b%x
  end function real_add

end module

program main
  use temp , operator(.plus.) => operator(.add.)
  type(real_num) :: a,b,c
  c=a.plus.b
end program

```

Example: Invalid because operator has a private attribute

```

module temp
  type real_num

```

```

real :: x
end type

interface operator (.add.)
module procedure real_add
end interface

private :: operator(.add.) !operator is given the private attribute

contains
function real_add(a,b)
type(real_num) :: real_add
type(real_num), intent(in) :: a,b
real_add%x = a%x+b%x
end function real_add

contains

end module

program main
!operator cannot be renamed because it has a private attribute.
use temp , operator(.plus.) => operator(.add.)
type(real_num) :: a,b,c
c=a.plus.b
end program

```

The following example is invalid:

```

Module mod1
  use, intrinsic :: ieee_exceptions
end Module

Module mod2
  use, non_intrinsic :: ieee_exceptions
end Module

Program invalid_example
  use mod1
  use mod2
! ERROR: a scoping unit must not access an
! intrinsic module and a non-intrinsic module
! with the same name.

end program

```

---

End of Fortran 2003

## Related information

- “Modules” on page 171
- “PRIVATE” on page 416
- “VOLATILE” on page 474
- “PUBLIC” on page 424
- “Order of statements and execution sequence” on page 14

## Purpose

The **VALUE** attribute specifies an argument association between a dummy and an actual argument. This association allows you to pass the dummy argument with the value of the actual argument. This Fortran 2003 pass by value implementation provides a standard conforming option to the **%VAL** built-in function.

An actual argument and the associated dummy argument can change independently. Changes to the value or definition status of the dummy argument do not affect the actual argument. A dummy argument with the **VALUE** attribute becomes associated with a temporary variable with an initial value identical to the value of the actual argument.

## Syntax

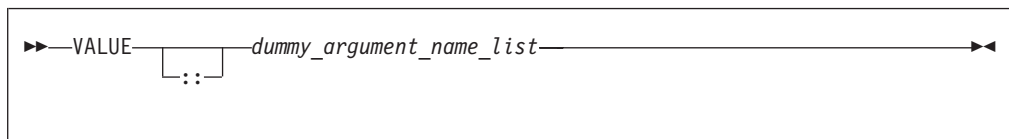

## Rules

You must specify the **VALUE** attribute for dummy arguments only.

You must not use the **%VAL** or **%REF** built-in functions to reference a dummy argument with the **VALUE** attribute, or the associated actual argument.

A referenced procedure that has a dummy argument with the **VALUE** attribute must have an explicit interface.

A dummy argument with the **VALUE** attribute can be of character type .

You must not specify the **VALUE** attribute with the following:

- Arrays
- Dummy procedures
- Polymorphic items

### Attributes compatible with the VALUE attribute

- INTENT(IN)
- OPTIONAL
- TARGET

If a dummy argument has both the **VALUE** and **TARGET** attributes, any pointers associated with that dummy argument become undefined after the execution of the procedure.

## Examples

```
Program validexml
  integer :: x = 10, y = 20
  print *, 'before calling: ', x, y
  call intersub(x, y)
  print *, 'after calling: ', x, y

  contains
  subroutine intersub(x,y)
    integer, value :: x
    integer y
    x = x + y
    y = x*y
    print *, 'in subroutine after changing: ', x, y
  end subroutine
end program validexml
```

Expected output:

```
before calling: 10 20
in subroutine after changing: 30 600
after calling: 10 600
```

## Related information

For more information, see the %VAL built-in function.

End of Fortran 2003

---

## VECTOR

IBM Extension

### Purpose

A **VECTOR** type declaration statement specifies that one or more entities have a vector type.

### Syntax

You can declare a vector using **VECTOR**(*type\_spec*) as part of a type declaration statement. The type declaration statement contains the complete syntax for declaring a vector data type. In a **VECTOR**(*type\_spec*), *type\_spec* must specify **PIXEL**, **REAL** of kind 4, or **INTEGER** or **UNSIGNED** of kind 1, 2, or 4.

End of IBM Extension

---

## VIRTUAL

IBM Extension

### Purpose

The **VIRTUAL** statement specifies the name and dimensions of an array. It is an alternative form of the **DIMENSION** statement, although there is no **VIRTUAL** attribute.

### Syntax

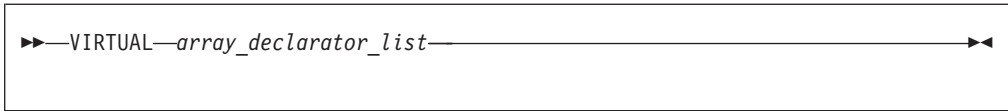

## Rules

You can specify arrays with a maximum of 20 dimensions

Only one array specification for an array name can appear in a scoping unit.

## Examples

```
VIRTUAL A(10), ARRAY(5,5,5), LIST(10,100)
VIRTUAL ARRAY2(1:5,1:5,1:5), LIST2(I,M) ! adjustable array
VIRTUAL B(0:24), C(-4:2), DATA(0:9,-5:4,10)
VIRTUAL ARRAY (M*N*J,*) ! assumed-size array
```

## Related information

- Chapter 5, “Array concepts,” on page 71
- “DIMENSION” on page 322

End of IBM Extension

## VOLATILE

### Purpose

The **VOLATILE** attribute is used to designate a data object as being mapped to memory that can be accessed by independent input/output processes and independent, asynchronously interrupting processes. Code that manipulates volatile data objects is not optimized.

### Syntax

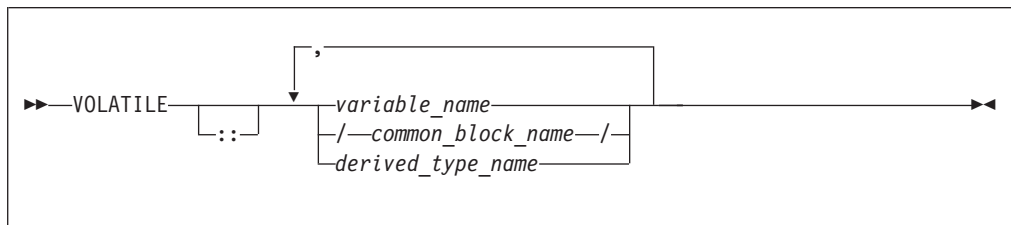

### Rules

If an array name is declared volatile, each element of the array is considered volatile. If a common block is declared volatile, each variable in the common block is considered volatile. An element of a common block can be declared volatile without affecting the status of the other elements in the common block.

If a common block is declared in multiple scopes, and if it (or one or more of its elements) is declared volatile in one of those scopes, you must specify the **VOLATILE** attribute in each scope where you require the common block (or one or more of its elements) to be considered volatile.

If a derived type name is declared volatile, all variables declared with that type are considered volatile. If an object of derived type is declared volatile, all of its components are considered volatile. If a component of a derived type is itself derived, the component does not inherit the volatile attribute from its type. A derived type name that is declared volatile must have had the **VOLATILE** attribute prior to any use of the type name in a type declaration statement.

If a pointer is declared volatile, the storage of the pointer itself is considered volatile. The **VOLATILE** attribute has no effect on any associated pointer targets.

If you declare an object to be volatile and then use it in an **EQUIVALENCE** statement, all of the objects that are associated with the volatile object through equivalence association are considered volatile.

Any data object that is shared across threads and is stored and read by multiple threads must be declared as **VOLATILE**. If, however, your program only uses the automatic or directive-based parallelization facilities of the compiler, variables that have the **SHARED** attribute need not be declared **VOLATILE**.

If the actual argument associated with a dummy argument is a variable that is declared volatile, you must declare the dummy argument volatile if you require the dummy argument to be considered volatile. If a dummy argument is declared volatile, and you require the associated actual argument to be considered volatile, you must declare the actual argument as volatile.

Declaring a statement function as volatile has no effect on the statement function.

Within a function subprogram, the function result variable can be declared volatile. Any entry result variables will be considered volatile. An **ENTRY** name must not be specified with the **VOLATILE** attribute.

---

### Fortran 2003

---

#### Using **-qxf2003=volatile**

If an actual argument is an array section or an assumed-shape array, and the corresponding dummy argument has the **VOLATILE** attribute, that dummy argument shall be an assumed-shape array.

If an actual argument is a pointer array, and the corresponding dummy argument has the **VOLATILE** attribute, that dummy argument shall be an assumed-shape array or a pointer array.

If the actual argument is an array section having a vector subscript, the dummy argument is not definable and shall not have the **VOLATILE** attribute.

Host associated entities are known by the same name and have the same attributes as in the host, except that an accessed entity may have the **VOLATILE** attribute even if the host entity does not.

In an internal or module procedure, if a variable that is accessible via host association is specified in a **VOLATILE** statement, that host variable is given the **VOLATILE** attribute in the local scope.

A use associated entity may have the **VOLATILE** attribute in the local scoping unit even if the associated module entity does not.

End of Fortran 2003

#### Attributes compatible with the **VOLATILE** attribute

- ALLOCATABLE
- ASYNCHRONOUS
- AUTOMATIC
- DIMENSION
- INTENT **1**
- OPTIONAL
- POINTER
- PRIVATE
- PROTECTED
- PUBLIC
- SAVE
- STATIC
- TARGET

#### Notes:

1. IBM Extension

Specifying **INTENT(IN)** with **VOLATILE** is an IBM Extension.

## Examples

```
FUNCTION TEST ()
  REAL ONE, TWO, THREE
  COMMON /BLOCK1/A, B, C
  ...
  VOLATILE /BLOCK1/, ONE, TEST
! Common block elements A, B and C are considered volatile
! since common block BLOCK1 is declared volatile.
  ...
  EQUIVALENCE (ONE, TWO), (TWO, THREE)
! Variables TWO and THREE are volatile as they are equivalenced
! with variable ONE which is declared volatile.
END FUNCTION
```

## Related information

- “Direct access” on page 203

## WAIT

#### IBM Extension

### Purpose

The **WAIT** statement may be used to wait for an asynchronous data transfer to complete or it may be used to detect the completion status of an asynchronous data transfer statement.

### Syntax

```
▶▶—WAIT—(—wait_list—)————▶▶
```

*wait\_list*

is a list that must contain one **ID=** specifier and at most one of each of the



other valid specifiers. The valid specifiers are:

---

**Fortran 2003**

---

**ASYNCHRONOUS=***char\_expr*

allows execution to continue without waiting for the data transfer to complete. *char\_expr* is a scalar character expression that must evaluate to **YES** or **NO**.

If a **DONE=** specifier appears, an **ID=** specifier must also appear. If the **ID=** specifier appears, a wait operation for the specified data transfer operation is performed. If there is no **ID=** specifier then wait operations for all pending data transfers for the specified unit are performed. Execution of a file positioning statement performs a wait operation for all pending asynchronous data transfer operations for the specified unit.

---

**End of Fortran 2003**

---

**DONE=** *logical\_variable*

specifies whether or not the asynchronous I/O statement is complete. If the **DONE=** specifier is present, the *logical\_variable* is set to true if the asynchronous I/O is complete and is set to false if it is not complete. If the returned value is false, then one or more **WAIT** statements must be executed until either the **DONE=** specifier is not present, or its returned value is true. A **WAIT** statement without the **DONE=** specifier, or a **WAIT** statement that sets the *logical\_variable* value to true, is the matching **WAIT** statement to the data transfer statement identified by the same **ID=** value.

**END=** *stmt\_label*

is an end-of-file specifier that specifies a statement label at which the program is to continue if an endfile record is encountered and no error occurs. If an external file is positioned after the endfile record, the **IOSTAT=** specifier, if present, is assigned a negative value, and the **NUM=** specifier, if present, is assigned an integer value. Coding the **END=** specifier suppresses the error message for end-of-file. This specifier can be specified for a unit connected for either sequential or direct access.

The *stmt\_label* defined for the **END=** specifier of the asynchronous data transfer statement need not be identical to the *stmt\_label* defined for the **END=** specifier of the matching **WAIT** statement.

**ERR=** *stmt\_label*

is an error specifier that specifies the statement label of an executable statement in the same scoping unit to which control is to transfer in case of an error. Coding the **ERR=** specifier suppresses error messages.

The *stmt\_label* defined for the **ERR=** specifier of the asynchronous data transfer statement need not be identical to the *stmt\_label* defined for the **ERR=** specifier of the matching **WAIT** statement.

**ID=** *integer\_expr*

indicates the data transfer with which this **WAIT** statement is identified. The *integer\_expr* is an integer expression of type **INTEGER(4)** or default integer. To initiate an asynchronous data transfer, the **ID=** specifier is used on a **READ** or **WRITE** statement.

**IOMSG=** *iomsg\_variable*

is an input/output status specifier that specifies the message returned by the input/output operation. *iomsg\_variable* is a scalar default character variable. It must not be a use-associated nonpointer protected variable.

When the input/output statement containing this specifier finishes execution, *iormsg\_variable* is defined as follows:

- If an error, end-of-file, or end-of-record condition occurs, the variable is assigned an explanatory message as if by assignment.
- If no such condition occurs, the value of the variable is unchanged.

**IOSTAT=** *ios*

is an input/output status specifier that specifies the status of the input/output operation. *ios* is an integer variable. When the input/output statement containing this specifier finishes execution, *ios* is defined with:

- A zero value if no error condition occurs.
- A positive value if an error occurs.
- A negative value if an end-of-file condition is encountered and no error occurs.

The *ios* defined for the **IOSTAT=** specifier of the asynchronous data transfer statement is not required to be identical to the *ios* defined for the **IOSTAT=** specifier of the matching **WAIT** statement.

## Rules

The matching **WAIT** statement must be in the same scoping unit as the corresponding asynchronous data transfer statement. Within the instance of that scoping unit, the program must not execute a **RETURN**, **END**, or **STOP** statement before the matching **WAIT** statement is executed.

## Related information

- “Asynchronous Input/Output” on page 207
- *Implementation details of XL Fortran Input/Output in the XL Fortran Optimization and Programming Guide*

End of IBM Extension

## WHERE

### Purpose

The **WHERE** statement masks the evaluation of expressions and assignments of values in array assignment statements. It does this according to the value of a logical array expression. The **WHERE** statement can be the initial statement of the **WHERE** construct.

### Syntax

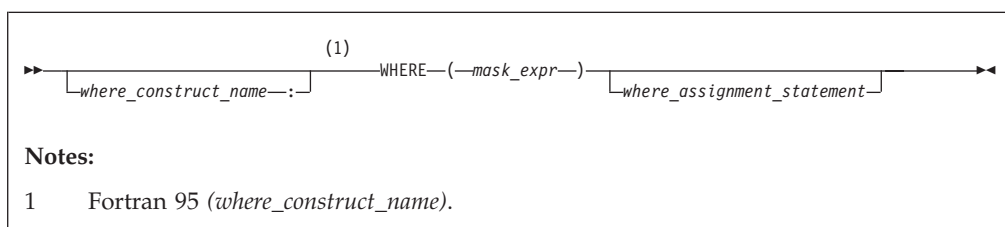

*mask\_expr*  
is a logical array expression

Fortran 95

*where\_construct\_name*  
is a name that identifies the **WHERE** construct

End of Fortran 95

## Rules

If a *where\_assignment\_statement* is present, the **WHERE** statement is not the first statement of a **WHERE** construct. If a *where\_assignment\_statement* is absent, the **WHERE** statement is the first statement of the **WHERE** construct, and is referred to as a **WHERE** construct statement. An **END WHERE** statement must follow. See “WHERE construct” on page 113 for more information.

If the **WHERE** statement is not the first statement of a **WHERE** construct, you can use it as the terminal statement of a **DO** or **DO WHILE** construct.

Fortran 95

You can nest **WHERE** statements within a **WHERE** construct. A *where\_assignment\_statement* that is a defined assignment must be an elemental defined assignment.

End of Fortran 95

In each *where\_assignment\_statement*, the *mask\_expr* and the *variable* being defined must be arrays of the same shape. Each *mask\_expr* in a **WHERE** construct must have the same shape.

Fortran 95

A **WHERE** statement that is part of a *where\_body\_construct* must not be a branch target statement.

End of Fortran 95

The execution of a function reference in the *mask\_expr* of a **WHERE** statement can affect entities in the *where\_assignment\_statement*.

See “Interpreting masked array assignments” on page 115 for information on interpreting mask expressions.

Fortran 95

If a *where\_construct\_name* appears on a **WHERE** construct statement, it must also appear on the corresponding **END WHERE** statement. A construct name is optional on any masked **ELSEWHERE** and **ELSEWHERE** statements in the **WHERE** construct.

A *where\_construct\_name* can only appear on a **WHERE** construct statement.

End of Fortran 95

## Examples

```
REAL, DIMENSION(10) :: A,B,C

! In the following WHERE statement, the LOG of an element of A
! is assigned to the corresponding element of B only if that
! element of A is a positive value.

WHERE (A>0.0) B = LOG(A)

:
END
```

### Fortran 95

The following example shows an elemental defined assignment in a **WHERE** statement:

```
INTERFACE ASSIGNMENT(=)
  ELEMENTAL SUBROUTINE MY_ASSIGNMENT(X, Y)
    LOGICAL, INTENT(OUT) :: X
    REAL, INTENT(IN) :: Y
  END SUBROUTINE MY_ASSIGNMENT
END INTERFACE

INTEGER A(10)
REAL C(10)
LOGICAL L_ARR(10)

C = (/ -10., 15.2, 25.5, -37.8, 274.8, 1.1, -37.8, -36.2, 140.1, 127.4 /)
A = (/ 1, 2, 7, 8, 3, 4, 9, 10, 5, 6 /)
L_ARR = .FALSE.

WHERE (A < 5) L_ARR = C

! DATA IN ARRAY L_ARR AT THIS POINT:
!
! L_ARR = F, T, F, F, T, T, F, F, F, F

END

ELEMENTAL SUBROUTINE MY_ASSIGNMENT(X, Y)
  LOGICAL, INTENT(OUT) :: X
  REAL, INTENT(IN) :: Y

  IF (Y < 0.0) THEN
    X = .FALSE.
  ELSE
    X = .TRUE.
  ENDIF
END SUBROUTINE MY_ASSIGNMENT
```

### End of Fortran 95

## Related information

- “WHERE construct” on page 113
- “ELSEWHERE” on page 333
- “END (Construct)” on page 336, for details on the **END WHERE** statement

# WRITE

## Purpose

The **WRITE** statement is a data transfer output statement.

## Syntax

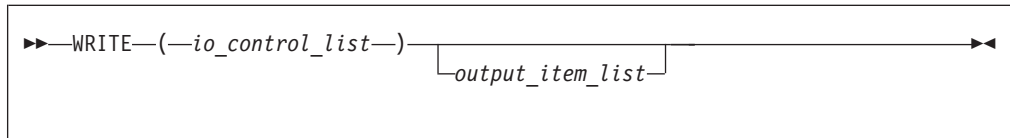

### *output\_item*

is an output list item. An output list specifies the data to be transferred. An output list item can be:

- A variable name. An array is treated as if all of its elements were specified in the order in which they are arranged in storage. A pointer must be associated with a target, and an allocatable object must be allocated. A derived-type object cannot have any ultimate component that is outside the scoping unit of this statement. The evaluation of *output\_item* cannot result in a derived-type object that contains a pointer. The structure components of a structure in a formatted statement are treated as if they appear in the order of the derived-type definition; in an unformatted statement, the structure components are treated as a single value in their internal representation (including padding).
- An expression
- An implied-**DO** list, as described under “Implied-DO List” on page 487

### Fortran 2003

An *output\_item* must not be a procedure pointer.

### End of Fortran 2003

### *io\_control*

is a list that must contain one unit specifier (**UNIT=**), and can also contain one of each of the other valid specifiers:

### **[UNIT=]** *u*

is a unit specifier that specifies the unit to be used in the output operation. *u* is an external unit identifier or internal file identifier.

### IBM Extension

An external unit identifier refers to an external file. It is one of the following:

- An integer expression whose value is in the range 0 through 2,147,483,647.
- An asterisk, which identifies external unit 6 and is preconnected to standard output.

### End of IBM Extension

An internal file identifier refers to an internal file. It is the name of a character variable, which cannot be an array section with a vector subscript.

If the optional characters **UNIT=** are omitted, *u* must be the first item in *io\_control\_list*. If **UNIT=** is specified, **FMT=** must also be specified.

**[FMT=]** *format*

is a format specifier that specifies the format to be used in the output operation. *format* is a format identifier that can be:

- The statement label of a **FORMAT** statement. The **FORMAT** statement must be in the same scoping unit.
- The name of a scalar **INTEGER(4)** or **INTEGER(8)** variable that was assigned the statement label of a **FORMAT** statement. The **FORMAT** statement must be in the same scoping unit.

---

**Fortran 95**

Fortran 95 does not permit assigning of a statement label.

---

**End of Fortran 95**

- A character constant enclosed in parentheses. Only the format codes listed under “**FORMAT**” on page 360 can be used between the parentheses. Blank characters can precede the left parenthesis or follow the right parenthesis.
- A character variable that contains character data whose leftmost character positions constitute a valid format. A valid format begins with a left parenthesis and ends with a right parenthesis. Only the format codes described in the **FORMAT** statement can be used between the parentheses. Blank characters can precede the left parenthesis or follow the right parenthesis. If *format* is an array element, the format identifier must not exceed the length of the array element.
- An array of noncharacter intrinsic type. The data must be a valid format identifier as described under character array.
- Any character expression, except one involving concatenation of an operand that specifies inherited length, unless the operand is the name of a constant.
- An asterisk, specifying list-directed formatting.
- A namelist specifier that specifies the name of a namelist list that you have previously defined.

If the optional characters **FMT=** are omitted, *format* must be the second item in *io\_control\_list*, and the first item must be the unit specifier with **UNIT=** omitted. **NML=** and **FMT=** cannot both be specified in the same output statement.

---

**IBM Extension**

**ASYNCH=** *char\_expr*

is an asynchronous I/O specifier that indicates whether an explicitly connected unit is to be used for asynchronous I/O.

*char\_expr* is a scalar character expression whose value is either **YES** or **NO**. **YES** specifies that asynchronous data transfer statements are permitted for this connection. **NO** specifies that asynchronous data transfer statements

are not permitted for this connection. The value specified will be in the set of transfer methods permitted for the file. If this specifier is omitted, the default value is **NO**.

Preconnected units are connected with an **ASYNCH=** value of **NO**.

The **ASYNCH=** value of an implicitly connected unit is determined by the first data transfer statement performed on the unit. If the first statement performs an asynchronous data transfer and the file being implicitly connected permits asynchronous data transfers, the **ASYNCH=** value is **YES**. Otherwise, the **ASYNCH=** value is **NO**.

---

End of IBM Extension

---

---

Fortran 2003

---

**ASYNCHRONOUS=***char\_expr*

allows execution to continue without waiting for the data transfer to complete. *char\_expr* is a scalar character expression that must evaluate to **YES** or **NO**. **ASYNCHRONOUS=YES** must not appear unless **UNIT=** specifies a file unit number. If **ID=** appears, an **ASYNCHRONOUS=YES** must also appear.

A statement and the I/O operation are synchronous if **ASYNCHRONOUS=NO** or if both **ASYNCHRONOUS=** and **ID=** are absent. For **ASYNCHRONOUS=YES** or if **ID=** appears, asynchronous I/O is permitted only for external files opened with **ASYNCHRONOUS=YES** in the **OPEN** statement.

If a variable is used in an asynchronous data transfer statement as an item in an I/O list, a group object in a namelist or as a **SIZE=** specifier, the base object of the *data\_ref* is implicitly given the **ASYNCHRONOUS** attribute in the scoping unit of the data transfer statement. For asynchronous nonadvancing input, the storage units specified in the **SIZE=** specifier become defined with the count of the characters transferred when the corresponding wait operation is executed. For asynchronous output, a pending I/O storage sequence affector shall not be redefined, become undefined, or have its pointer association status changed. For asynchronous input, a pending I/O storage sequence affector shall not be referenced, become defined, become undefined, become associated with a dummy argument that has the **VALUE** attribute, or have its pointer association status changed.

When an error, end-of-file or end-of-record condition occurs for a previously executed asynchronous data transfer statement, a wait operation is performed for all pending data transfer operations on that unit. When a condition occurs during a subsequent statement, any actions specified by **IOSTAT=**, **IOMSG=**, **ERR=**, **END=**, and **EOR=** specifiers for that statement are taken.

A wait operation is performed by a **WAIT**, **CLOSE**, or file positioning statement.

---

End of Fortran 2003

---

---

Fortran 2003

---

**DECIMAL=** *char\_expr*

temporarily changes the default *decimal edit mode* for the duration of an I/O statement. *char\_expr* is a scalar character expression whose value must evaluate to either **POINT**, or **COMMA**. After each **WRITE** statement, the mode defaults to whatever decimal mode was specified (or assumed) on the **OPEN** statement for that unit.

End of Fortran 2003

Fortran 2003

**POS=***integer\_expr*

*integer\_expr* is an integer expression greater than 0. **POS=** specifies the file position of the file storage unit to be written in a file connected for stream access. You must not use **POS=** for a file that cannot be positioned.

End of Fortran 2003

**REC=** *integer\_expr*

is a record specifier that specifies the number of the record to be written in a file connected for direct access. The **REC=** specifier is only permitted for direct output. *integer\_expr* is an integer expression whose value is positive. A record specifier is not valid if formatting is list-directed or if the unit specifier specifies an internal file. The record specifier represents the relative position of a record within a file. The relative position number of the first record is 1. You must not specify **REC=** in data transfer statements that specify a unit connected for stream access, or use the **POS=** specifier.

Fortran 2003

**ROUND=** *char-expr*

temporarily changes the current value of the I/O rounding mode for the duration of this I/O statement. If omitted, then the rounding mode is unchanged. *char-expr* evaluates to either **UP**, **DOWN**, **ZERO**, **NEAREST**, **COMPATIBLE** or **PROCESSOR\_DEFINED**

The rounding mode helps specify how decimal numbers are converted to an internal representation, (that is, in binary) from a character representation and vice versa during formatted input and output. The rounding modes have the following functions:

- In the **UP** rounding mode the value from the conversion is the smallest value that is greater than or equal to the original value.
- In the **DOWN** rounding mode the value from the conversion is the greatest value that is smaller than or equal to the original value.
- In the **ZERO** rounding mode the value from the conversion is the closest value to the original value, and not greater in magnitude.
- In the **NEAREST** rounding mode the value from the conversion is the closer of the two nearest representable values. If both values are equally close then the even value will be chosen. In IEEE rounding conversions, **NEAREST** corresponds to the `ieee_nearest` rounding mode as specified by the IEEE standard.
- In the **COMPATIBLE** rounding mode the value from the conversion is the closest of the two nearest representable values, or the value further away from zero if halfway between.



- In the **PROCESSOR\_DEFINED** rounding mode the value from the conversion is processor dependent and may correspond to the other modes. In the **PROCESSOR\_DEFINED** rounding mode the value from the conversion is processor dependent and may correspond to the other modes. In XL Fortran, the **PROCESSOR\_DEFINED** rounding mode will be the rounding mode you choose in the floating-point control register. If you do not set the floating-point control register explicitly, the default rounding mode is **NEAREST**.

End of Fortran 2003

Fortran 2003

**SIGN=** *char\_expr*

indicates the sign mode in effect for a connection for formatted input/output. If *char\_expr* is assigned the value **PLUS**, the processor shall produce a plus sign in any position that normally contains an optional plus sign and suppresses plus signs in these positions if *char\_expr* is assigned the value **SUPPRESS**. *char\_expr* can also be assigned the value **PROCESSOR\_DEFINED** which is the default sign mode and acts the same as **SUPPRESS**. If there is no connection, or if the connection is not for formatted input/output, *char\_expr* is assigned the value **UNDEFINED**.

End of Fortran 2003

Fortran 2003

**IOMSG=** *iomsg\_variable*

is an input/output status specifier that specifies the message returned by the input/output operation. *iomsg\_variable* is a scalar default character variable. It must not be a use-associated nonpointer protected variable. When the input/output statement containing this specifier finishes execution, *iomsg\_variable* is defined as follows:

- If an error, end-of-file, or end-of-record condition occurs, the variable is assigned an explanatory message as if by assignment.
- If no such condition occurs, the value of the variable is unchanged.

End of Fortran 2003

**IOSTAT=** *ios*

is an input/output status specifier that specifies the status of the input/output operation. *ios* is an integer variable. Coding the **IOSTAT=** specifier suppresses error messages. When the statement finishes execution, *ios* is defined with:

- A zero value if no error condition occurs
- A positive value if an error occurs.

IBM Extension

**ID=** *integer\_variable*

indicates that the data transfer is to be done asynchronously. The *integer\_variable* is an integer variable. If no error is encountered, the

*integer\_variable* is defined with a value after executing the asynchronous data transfer statement. This value must be used in the matching **WAIT** statement.

Asynchronous data transfer must either be direct unformatted, sequential unformatted, or stream unformatted. Asynchronous I/O to internal files is prohibited. Asynchronous I/O to raw character devices (for example, tapes or raw logical volumes) is prohibited. The *integer\_variable* must not be associated with any entity in the data transfer I/O list, or with a *do\_variable* of an *io\_implied\_do* in the data transfer I/O list. If the *integer\_variable* is an array element reference, its subscript values must not be affected by the data transfer, the *io\_implied\_do* processing, or the definition or evaluation of any other specifier in the *io\_control\_spec*.

End of IBM Extension

### Fortran 2003

**DELIM=** *char\_expr*

specifies what delimiter, if any, is used to delimit character constants written with list-directed or namelist formatting. *char\_expr* is a scalar character expression whose value must evaluate to **APOSTROPHE**, **QUOTE**, or **NONE**. If the value is **APOSTROPHE**, apostrophes delimit character constants and all apostrophes within character constants are doubled. If the value is **QUOTE**, double quotation marks delimit character constants and all double quotation marks within character constants are doubled. If the value is **NONE**, character constants are not delimited and no characters are doubled. The default value is **NONE**. The **DELIM=** specifier is permitted only for files being connected for formatted input/output, although it is ignored during input of a formatted record.

End of Fortran 2003

**ERR=** *stmt\_label*

is an error specifier that specifies the statement label of an executable statement in the same scoping unit to which control is to transfer in the case of an error. Coding the **ERR=** specifier suppresses error messages.

### IBM Extension

**NUM=** *integer\_variable*

is a number specifier that specifies the number of bytes of data transmitted between the I/O list and the file. *integer\_variable* is an integer variable. The **NUM=** specifier is only permitted for unformatted output. Coding the **NUM** parameter suppresses the indication of an error that would occur if the number of bytes represented by the output list is greater than the number of bytes that can be written into the record. In this case, *integer\_variable* is set to a value that is the maximum length record that can be written. Data from remaining output list items is not written into subsequent records. In the portion of the program that executes between the asynchronous data transfer statement and the matching **WAIT** statement, the *integer\_variable* in the **NUM=** specifier or any variable associated with it must not be referenced, become defined, or become undefined.

End of IBM Extension

[NML=] *name*

is a namelist specifier that specifies the name of a namelist list that you have previously defined. If the optional characters **NML=** are not specified, the namelist name must appear as the second parameter in the list, and the first item must be the unit specifier with **UNIT=** omitted. If both **NML=** and **UNIT=** are specified, all the parameters can appear in any order. The **NML=** specifier is an alternative to **FMT=**. Both **NML=** and **FMT=** cannot be specified in the same output statement.

**ADVANCE=** *char\_expr*

is an advance specifier that determines whether nonadvancing output occurs for this statement. *char\_expr* is a character expression that must evaluate to **YES** or **NO**. If **NO** is specified, nonadvancing output occurs. If **YES** is specified, advancing, formatted sequential or formatted stream output occurs. The default value is **YES**. **ADVANCE=** can be specified only in a formatted sequential **WRITE** statement with an explicit format specification that does not specify an internal file unit specifier.

## Implied-DO List

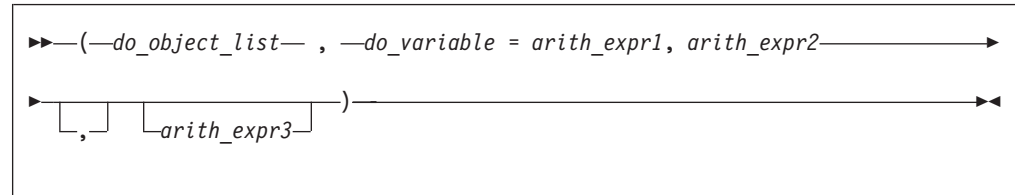

*do\_object*

is an output list item

*do\_variable*

is a named scalar variable of type integer or real

*arith\_expr1*, *arith\_expr2*, and *arith\_expr3*

are scalar numeric expressions

The range of an implied-**DO** list is the list *do\_object\_list*. The iteration count and values of the **DO** variable are established from *arith\_expr1*, *arith\_expr2*, and *arith\_expr3*, the same as for a **DO** statement. When the implied-**DO** list is executed, the items in the *do\_object\_list* are specified once for each iteration of the implied-**DO** list, with the appropriate substitution of values for any occurrence of the **DO** variable.

## Rules

### IBM Extension

If a **NUM=** specifier is present, neither a format specifier nor a namelist specifier can be present.

### End of IBM Extension

Variables specified for the **IOSTAT=** and **NUM=** specifiers must not be associated with any output list item, namelist list item, or **DO** variable of an implied-**DO** list. If such a specifier variable is an array element, its subscript values must not be affected by the data transfer, any implied-**DO** processing, or the definition or evaluation of any other specifier.

If the **ERR=** and **IOSTAT=** specifiers are set and an error is encountered during a synchronous data transfer, transfer is made to the statement specified by the **ERR=** specifier and a positive integer value is assigned to *ios*.

#### IBM Extension

If the **ERR=** or **IOSTAT=** specifiers are set and an error is encountered during an asynchronous data transfer, execution of the matching **WAIT** statement is not required.

If a conversion error is encountered and the **CNVERR** run-time option is set to **NO**, **ERR=** is not branched to, although **IOSTAT=** may be set.

If **IOSTAT=** and **ERR=** are not specified,

- The program stops if a severe error is encountered.
- The program continues to the next statement if a recoverable error is encountered and the **ERR\_RECOVERY** run-time option is set to **YES**. If the option is set to **NO**, the program stops.
- The program continues to the next statement when a conversion error is encountered if the **ERR\_RECOVERY** run-time option is set to **YES**. If the **CNVERR** run-time option is set to **YES**, conversion errors are treated as recoverable errors; when **CNVERR=NO**, they are treated as conversion errors.

#### End of IBM Extension

**PRINT** format has the same effect as **WRITE(\*,format)**.

## Examples

```
WRITE (6,FMT='(10F8.2)') (LOG(A(I)),I=1,N+9,K),G
```

## Related information

- “Asynchronous Input/Output” on page 207
- *Implementation details of XL Fortran Input/Output in the XL Fortran Optimization and Programming Guide*
- “Conditions and IOSTAT values” on page 214
- Chapter 9, “XL Fortran Input/Output,” on page 201
- “READ” on page 425
- “WAIT” on page 476
- *Setting run-time options for Input/Output in the XL Fortran Compiler Reference*
- “Deleted features” on page 818

---

## Chapter 12. Directives

### IBM Extension

This section provides an alphabetical reference to non-SMP directives that apply to all platforms. For a complete listing and description of SMP and thread-safe directives, see the detailed directive descriptions in the *XL Fortran Optimization and Programming Guide*. For a detailed description of directives exclusive to the PowerPC® platform, see Chapter 13, “Hardware-specific directives,” on page 519. This section contains the following:

- Comment and Noncomment Form Directives
- Directives and Optimization
- Detailed Directive Descriptions

---

### Comment and noncomment form directives

XL Fortran directives belong to one of two groups: comment form directives and noncomment form directives.

#### Comment form directives

This section describes the format of comment form directives. The non-SMP comment form directives include the following:

COLLAPSE	SNAPSHOT
SOURCEFORM	SUBSCRIPTORDER

Additional comment form directives can be found in “Directives and optimization” on page 492.

#### Format

▶▶—*trigger\_head*—*trigger\_constant*—*directive*—▶▶

*trigger\_head*

is one of **!**, **\***, **C**, or **c** for fixed source form and **!** for free source form.

*trigger\_constant*

is **IBM\*** by default.

#### Rules

The default value for the *trigger\_constant* is **IBM\***.

By default, if you use the **-qsmp** compiler option in conjunction with one of these invocation commands, the option **-qdirective=IBM\*:SMP\$:SOMP:IBMP:IBMT** will be on. If you specify the **-qsmp=omp** option this will be as if you set the option **-qdirective=\$OMP** on by default. You can specify an alternate or additional *trigger\_constant* with the **-qdirective** compiler option. See the **-qdirective** compiler option in the *XL Fortran Compiler Reference* for more details.

The compiler treats all comment form directives, with the exception of those using the default *trigger\_constant*, as comments, unless you define the appropriate *trigger\_constant* using the **-qdirective** compiler option. As a result, code containing these directives is portable to non-SMP environments.

XL Fortran supports the OpenMP specification, as understood and interpreted by IBM. To ensure the greatest portability of code, we recommend that you use these directives whenever possible. You should use them with the OpenMP *trigger\_constant*, **\$OMP**; but you should not use this *trigger\_constant* with any other directive.

XL Fortran also includes the *trigger\_constants* **IBMP** and **IBMT**. The compiler recognizes **IBMP** if you compile using the **-qsmp** compiler option. You should use **IBMP** with the **SCHEDULE** directive, and IBM extensions to OpenMP directives. The compiler recognizes **IBMT** if you compile using the **-qthreaded** compiler option. **IBMT** is the default for the **xlfr\_r**, **xlfr\_r7**, **xlfr90\_r**, **xlfr90\_r7**, **xlfr95\_r** or **xlfr95\_r7** invocation commands; we recommend its use with the **THREADLOCAL** directive.

XL Fortran directives include directives that are common to other vendors. If you use these directives in your code, you can enable whichever *trigger\_constant* that vendor has selected. Specifying the trigger constant by using the **-qdirective** compiler option will enable the *trigger\_constant* the vendor has selected. Refer to the **-qdirective** compiler option in the *XL Fortran Compiler Reference* for details on specifying alternative *trigger\_constants*.

The *trigger\_head* follows the rules of comment lines either in Fortran 90 free source form or fixed source form. If the *trigger\_head* is **!**, it does not have to be in column 1. There must be no blanks between the *trigger\_head* and the *trigger\_constant*.

You can specify the *directive\_trigger* (defined as the *trigger\_head* combined with the *trigger\_constant*, **!IBM\*** for example) and any directive keywords in uppercase, lowercase, or mixed case.

You can specify inline comments on directive lines.

```
!IBM* INDEPENDENT, NEW(i)    !This is a comment
```

A directive cannot follow another statement or another directive on the same line.

All comment form directives can be continued. You cannot embed a directive within a continued statement, nor can you embed a statement within a continued directive.

You must specify the *directive\_trigger* on all continuation lines. However, the *directive\_trigger* on a continuation line need not be identical to the *directive\_trigger* that is used in the continued line. For example:

```
!IBM* INDEPENDENT &  
!TRIGGER& , REDUCTION (X)           &  
!IBM*& , NEW (I)
```

The above is equivalent to:

```
!IBM* INDEPENDENT, REDUCTION (X), NEW (I)
```

provided both **IBM\*** and **TRIGGER** are active *trigger\_constants*.

For more information, see “Lines and source formats” on page 7.

You can specify a directive as a free source form or fixed source form comment, depending on the current source form.

**Fixed source form rules:** If the *trigger\_head* is one of **C**, **c**, or **\***, it must be in column 1.

The maximum length of the *trigger\_constant* in fixed source form is 4 for directives that are continued on one or more lines. This rule applies to the continued lines only, not to the initial line. Otherwise, the maximum length of the *trigger\_constant* is 15. We recommend that initial line triggers have a maximum length of 4. The maximum allowable length of 15 is permitted for the purposes of backwards compatibility.

If the *trigger\_constant* has a length of 4 or less, the first line of a comment directive must have either white space or a zero in column 6. Otherwise, the character in column 6 is part of the *trigger\_constant*.

The *directive\_trigger* of a continuation line of a comment directive must appear in columns 1-5. Column 6 of a continuation line must have a character that is neither white space nor a zero.

For more information, see “Fixed source form” on page 8.

**Free source form rules:** The *trigger\_head* is **!**. The maximum length of the *trigger\_constant* is 15.

An ampersand (&) at the end of a line indicates that the directive will continue. When you continue a directive line, a *directive\_trigger* must appear at the beginning of all continuation lines. If you are beginning a continuation line with an ampersand, the *directive\_trigger* must precede the ampersand. For example:

```
!IBM* INDEPENDENT &
!IBM*& , REDUCTION (X)      &
!IBM*& , NEW (I)
```

For more information, see “Free source form” on page 11.

## Noncomment form directives

This section describes the format of noncomment form directives, which include the following:

<b>EJECT</b>	<b>INCLUDE</b>
<b>#LINE</b>	<b>@PROCESS</b>

### Format

▶▶—*directive*—▶▶

### Rules

The compiler always recognizes noncomment form directives.

Noncomment form directives cannot be continued.

Additional statements cannot be included on the same line as a directive.

Source format rules concerning white space apply to directive lines.

---

## Directives and optimization

The following are comment form directives useful for optimizing programs. See *Optimizing XL compiler programs* in the *XL Fortran Optimization and Programming Guide* and the compiler options that affect performance.

### Assertive directives

Assertive directives gather information about source code that is otherwise unavailable to the compiler. Providing this information can increase performance.

ASSERT	CNCALL
INDEPENDENT	MEM_DELAY
PERMUTATION	

### Directives for Loop Optimization

The following directives provide different methods for loop optimization:

BLOCK_LOOP	LOOPID
STREAM_UNROLL	UNROLL
UNROLL_AND_FUSE	PREFETCH directives

---

## Detailed directive descriptions

### ASSERT

#### Purpose

The **ASSERT** directive provides the compiler with the characteristics of **DO** loops that can assist in optimizing source code.

The **ASSERT** directive takes effect when you specify the **-qhot** or **-qsmp** compiler options.

#### Syntax

```
▶▶—ASSERT—(—assertion_list—)————▶▶
```

*assertion*

is **ITERCNT**(*n*) or **NODEPS**. **ITERCNT**(*n*) and **NODEPS** are not mutually exclusive, and you can specify both for the same **DO** loop. You can use at most one of each argument for the same **DO** loop.

**ITERCNT**(*n*)

where *n* specifies the number of iterations for a given **DO** loop. *n* must be a positive, scalar, integer initialization expression.



## NODEPS

specifies that no loop-carried dependencies exist within a given **DO** loop.

### Rules

The first noncomment line (not including other directives) following the **ASSERT** directive must be a **DO** loop. This line cannot be an infinite **DO** or **DO WHILE** loop. The **ASSERT** directive applies only to the **DO** loop immediately following the directive, and not to any nested **DO** loops.

**ITERCNT** provides an estimate to the optimizer about roughly how many iterations the **DO** loop will typically run. There is no requirement that the value be accurate; **ITERCNT** will only affect performance, never correctness.

When **NODEPS** is specified, the user is explicitly declaring to the compiler that no loop-carried dependencies exist within the **DO** loop or any procedures invoked from within the **DO** loop. A loop-carried dependency involves two iterations within a **DO** loop interfering with one another. Interference occurs in the following situations:

- Two operations that define, undefine, or redefine the same atomic object (data that has no subobjects) interfere.
- Definition, undefinition, or redefinition of an atomic object interferes with any use of the value of the object.
- Any operation that causes the association status of a pointer to become defined or undefined interferes with any reference to the pointer or any other operation that causes the association status to become defined or undefined.
- Transfer of control outside the **DO** loop or execution of an **EXIT**, **STOP**, or **PAUSE** statement interferes with all other iterations.
- If any two input/output (I/O) operations associated with the same file or external unit interfere with each other. The exceptions to this rule are:
  - If the two I/O operations are two **INQUIRE** statements; or
  - **F2003** If the two I/O operations are accessing distinct areas of a stream access file; or **F2003**
  - If the two I/O operations are accessing distinct records of a direct access file.
- A change in the allocation status of an allocatable object between iterations causes interference.

It is possible for two complementary **ASSERT** directives to apply to any given **DO** loop. However, an **ASSERT** directive cannot be followed by a contradicting **ASSERT** directive for a given **DO** loop:

```
!IBM* ASSERT (ITERCNT(10))
!IBM* INDEPENDENT, REDUCTION (A)
!IBM* ASSERT (ITERCNT(20))      ! invalid
      DO I = 1, N
          A(I) = A(I) * I
      END DO
```

In the example above, the **ASSERT(ITERCNT(20))** directive contradicts the **ASSERT(ITERCNT(10))** directive and is invalid.

The **ASSERT** directive overrides the **-qassert** compiler option for the **DO** loop on which the **ASSERT** directive is specified.

### Examples

#### Example 1:

```

! An example of the ASSERT directive with NODEPS.
PROGRAM EX1
  INTEGER A(100)
  !IBM*  ASSERT (NODEPS)
  DO I = 1, 100
    A(I) = A(I) * FNC1(I)
  END DO
END PROGRAM EX1

FUNCTION FNC1(I)
  FNC1 = I * I
END FUNCTION FNC1

```

### Example 2:

```

! An example of the ASSERT directive with NODEPS and ITERCNT.
SUBROUTINE SUB2 (N)
  INTEGER A(N)
  !IBM*  ASSERT (NODEPS,ITERCNT(100))
  DO I = 1, N
    A(I) = A(I) * FNC2(I)
  END DO
END SUBROUTINE SUB2

FUNCTION FNC2 (I)
  FNC2 = I * I
END FUNCTION FNC2

```

### Related information

- **-qassert** option in the *XL Fortran Compiler Reference*
- **-qdirective** option in the *XL Fortran Compiler Reference*
- “Loop parallelization” on page 357

## BLOCK\_LOOP

### Purpose

The **BLOCK\_LOOP** directive allows you to exert greater control over optimizations on a specific **DO** loop inside a loop nest. Using a technique called blocking, the **BLOCK\_LOOP** directive separates large iteration count **DO** loops into smaller iteration groups. Execution of these smaller groups can increase the efficiency of cache space use and augment performance.

Applying **BLOCK\_LOOP** to a loop with dependencies, or a loop with alternate entry or exit points will produce unexpected results.

The **BLOCK\_LOOP** directive takes effect only when the **-qhot**, **-qipa**, or **-qsmp** compiler option is specified.

### Syntax

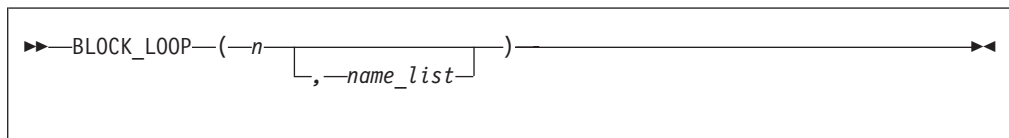

**n** is a positive integer expression as the size of the iteration group.

**name** a unique identifier in the same scoping unit as **BLOCK\_LOOP**, that you can create using the **LOOPID** directive.

If you do not specify *name*, blocking occurs on the first **DO** loop immediately following the **BLOCK\_LOOP** directive.

## Rules

For loop blocking to occur, a **BLOCK\_LOOP** directive must immediately precede a **DO** loop.

You must not specify the **BLOCK\_LOOP** directive more than once.

You must not specify the **BLOCK\_LOOP** directive for a **DO WHILE** loop or an infinite **DO** loop.

## Examples

```
! Loop Tiling for Multi-level Memory Heirarchy
  INTEGER :: M, N, i, j, k
  M = 1000
  N = 1000

  !IBM* BLOCK_LOOP(L3_cache_size, L3_cache_block)
  do i = 1, N

    !IBM* LOOPID(L3_cache_block)
    !IBM* BLOCK_LOOP(L2_cache_size, L2_cache_block)
    do j = 1, N

      !IBM* LOOPID(L2_cache_block)
      do k = 1, M
        do l = 1, M
          .
          .
          .
        end do
      end do
    end do
  end do

end
```

! The compiler generated code would be equivalent to:

```
do index1 = 1, M, L3_cache_size
  do i = 1, N
    do index2 = index1, min(index1 + L3_cache_size, M), L2_cache_size
      do j = 1, N
        do k = index2, min(index2 + L2_cache_size, M)
          do l = 1, M
            .
            .
            .
          end do
        end do
      end do
    end do
  end do
end do
```

## Related information

- For additional methods of optimizing loops, see the **STREAM UNROLL** and the **UNROLL** and **UNROLL\_AND\_FUSE** directives.

# CNCALL

## Purpose

When the **CNCALL** directive is placed before a **DO** loop, you are explicitly declaring to the compiler that no loop-carried dependencies exist within any procedure called from the **DO** loop.

This directive only takes effect if you specify either the **-qsmp** or **-qhot** compiler option.

## Syntax

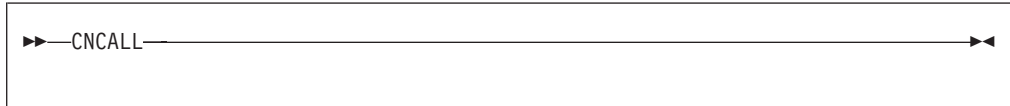

## Rules

The first noncomment line (not including other directives) that is following the **CNCALL** directive must be a **DO** loop. This line cannot be an infinite **DO** or **DO WHILE** loop. The **CNCALL** directive applies only to the **DO** loop that is immediately following the directive and not to any nested **DO** loops.

When specifying the **CNCALL** directive, you are explicitly declaring to the compiler that no procedures invoked within the **DO** loop have any loop-carried dependencies. If the **DO** loop invokes a procedure, separate iterations of the loop must be able to concurrently call that procedure. The **CNCALL** directive does not assert that other operations in the loop do not have dependencies, it is only an assertion about procedure references.

A loop-carried dependency occurs when two iterations within a **DO** loop interfere with one another. See the **ASSERT** directive for the definition of interference.

## Examples

```
! An example of CNCALL where the procedure invoked has
! no loop-carried dependency but the code within the
! DO loop itself has a loop-carried dependency.
PROGRAM EX3
  INTEGER A(100)
  !IBM* CNCALL
  DO I = 1, N
    A(I) = A(I) * FNC3(I)
    A(I) = A(I) + A(I-1)    ! This has loop-carried dependency
  END DO
END PROGRAM EX3

FUNCTION FNC3 (I)
  FNC3 = I * I
END FUNCTION FNC3
```

## Related information

- “INDEPENDENT ” on page 500
- **-qdirective** in the *XL Fortran Compiler Reference*
- **-qhot** Option in the *XL Fortran Compiler Reference*
- **-qsmp** Option in the *XL Fortran Compiler Reference*
- “DO” on page 323
- “Loop parallelization” on page 357

# COLLAPSE

## Purpose

The **COLLAPSE** directive reduces an entire array dimension to a single element by specifying that only the element in the lower bound of an array dimension is accessible. If you do not specify a lower bound, the default lower bound is one.

Used with discretion, the **COLLAPSE** directive can facilitate an increase in performance by reducing repetitive memory access associated with multiple-dimension arrays.

## Syntax

```
▶▶—COLLAPSE—(—collapse_array_list—)————▶▶
```

where *collapse\_array* is:

```
▶▶—array_name—(—expression_list—)————▶▶
```

where *expression\_list* is a comma separated list of *expression*.

*array name*

is the array name.

*expression*

is a constant scalar integer expression. You may only specify positive integer values.

## Rules

The **COLLAPSE** directive must contain at least one array.

The **COLLAPSE** directive applies only to the scoping unit in which it is specified. The declarations of arrays contained in a **COLLAPSE** directive must appear in the same scoping unit as the directive. An array that is accessible in a scoping unit by use or host association must not be specified in a **COLLAPSE** directive in that scoping unit.

The lowest value you can specify in *expression\_list* is one. The highest value must not be greater than the number of dimensions in the corresponding array.

A single scoping unit can contain multiple **COLLAPSE** declarations, though you can only specify an array once for a particular scoping unit.

You can not specify an array in both a **COLLAPSE** directive and an **EQUIVALENCE** statement.

You can not use the **COLLAPSE** directive with arrays that are components of derived types.

If you apply both the **COLLAPSE** and **SUBSCRIPTORDER** directives to an array, you must specify the **SUBSCRIPTORDER** directive first.

The **COLLAPSE** directive applies to:

- Assumed-shape arrays in which all lower bounds must be constant expressions.
- Explicit-shape arrays in which all lower bounds must be constant expressions.

## Examples

**Example 1:** In the following example, the **COLLAPSE** directive is applied to the explicit-shape arrays *A* and *B*. Referencing *A(m,2:100,2:100)* and *B(m,2:100,2:100)* in the inner loops, become *A(m,1,1)* and *B(m,1,1)*.

```
!IBM* COLLAPSE(A(2,3),B(2,3))
      REAL*8 A(5,100,100), B(5,100,100), c(5,100,100)

      DO I=1,100
        DO J=1,100
          DO M=1,5
            A(M,J,I) = SIN(C(M,J,I))
            B(M,J,I) = COS(C(M,J,I))
          END DO
          DO M=1,5
            DO N=1,M
              C(M,J,I) = C(M,J,I) + A(N,J,I)*B(6-N,J,I)
            END DO
          END DO
        END DO
      END DO
      END
```

## Related information

For more information on the **SUBSCRIPTORDER** directive, see “SUBSCRIPTORDER” on page 513

## EJECT

### Purpose

**EJECT** directs the compiler to start a new full page of the source listing. If there has been no source listing requested, the compiler will ignore this directive.

### Syntax

▶—EJECT—▶
-----------

### Rules

The **EJECT** compiler directive can have an inline comment and a label. However, if you specify a statement label, the compiler discards it. Therefore, you must not reference any label on an **EJECT** directive. An example of using the directive would be placing it before a **DO** loop that you do not want split across pages in the listing. If you send the source listing to a printer, the **EJECT** directive provides a page break.

## INCLUDE

### Purpose

The **INCLUDE** compiler directive inserts a specified statement or a group of statements into a program unit.

## Syntax

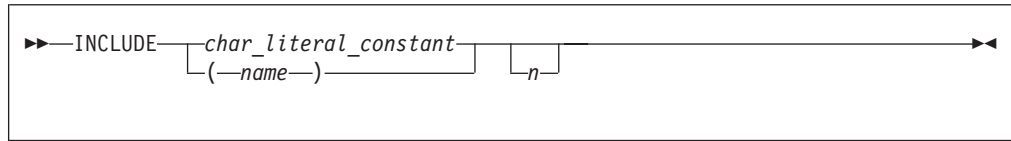

*name*, *char\_literal\_constant* (delimiters are optional)  
specifies *filename*, the name of an include file

You are not required to specify the full path of the desired file, but must specify the file extension if one exists.

*name* must contain only characters allowable in the XL Fortran character set. See “Characters” on page 5 for the character set supported by XL Fortran.

*char\_literal\_constant* is a character literal constant.

*n* is the value the compiler uses to decide whether to include the file during compilation. It can be any number from 1 through 255, and cannot specify a kind type parameter. If you specify *n*, the compiler includes the file only if the number appears as a suboption in the **-qci** (conditional include) compiler option. If you do not specify *n*, the compiler always includes the file.

Conditional include allows you to selectively activate **INCLUDE** directives within Fortran source during compilation. Specify the files to include using the **-qci** compiler option.

In fixed source form, the **INCLUDE** compiler directive must start after column 6, and can have a label.

You can add an inline comment to the **INCLUDE** line.

### Rules

An included file can contain any complete Fortran source statements and compiler directives, including other **INCLUDE** compiler directives. Recursive **INCLUDE** compiler directives are not allowed. An **END** statement can be part of the included group. The first and last included lines must not be continuation lines. The statements in the include file are processed with the source form of the including file.

If the **SOURCEFORM** directive appears in an include file, the source form reverts to that of the including file once processing of the include file is complete. After the inclusion of all groups, the resulting Fortran program must follow all of the Fortran rules for statement order.

For an **INCLUDE** compiler directive with the left and right parentheses syntax, XL Fortran translates the file name to lowercase unless the **-qmixed** compiler option is on.

The file system locates the specified *filename* as follows:

- If the first nonblank character of *filename* is */*, *filename* specifies an absolute file name.
- If the first nonblank character is not */*, the operating system searches directories in order of decreasing priority:

- If you specify any **-I** compiler option, *filename* is searched for in the directories specified.
- If the operating system cannot find *filename* then it searches:
  - the current directory for file *filename*.
  - the resident directory of the compiling source file for file *filename*.
  - directory `/usr/include` for file *filename*.

### Examples

```
INCLUDE '/u/userid/dc101'      ! full absolute file name specified
INCLUDE '/u/userid/dc102.inc' ! INCLUDE file name has an extension
INCLUDE 'userid/dc103'       ! relative path name specified
INCLUDE (ABCdef)             ! includes file abcdef
INCLUDE '../Abc'             ! includes file Abc from parent directory
                             ! of directory being searched
```

### Related information

**-qci** Option in the *XL Fortran Compiler Reference*

## INDEPENDENT

### Purpose

The **INDEPENDENT** directive, if used, must precede a **DO** loop, **FORALL** statement, or **FORALL** construct. It specifies that each operation in the **FORALL** statement or **FORALL** construct, can be executed in any order without affecting the semantics of the program. It also specifies each iteration of the **DO** loop, can be executed without affecting the semantics of the program.

### Type

This directive only takes effect if you specify either the **-qsmp** or **-qhot** compiler option.

### Syntax

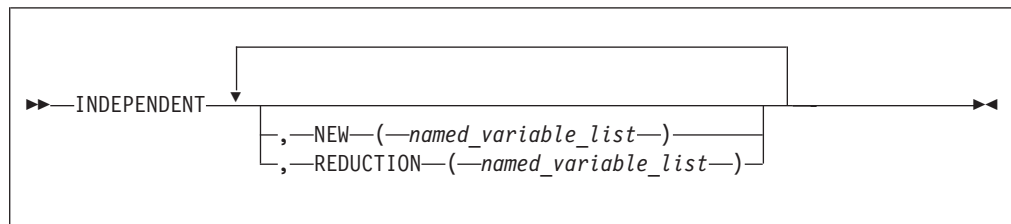



### Rules

The first noncomment line (not including other directives) following the **INDEPENDENT** directive must be a **DO** loop, **FORALL** statement, or the first statement of a **FORALL** construct. This line cannot be an infinite **DO** or **DO WHILE** loop. The **INDEPENDENT** directive applies only to the **DO** loop that is immediately following the directive and not to any nested **DO** loops.

An **INDEPENDENT** directive can have at most one **NEW** clause and at most one **REDUCTION** clause.

If the directive applies to a **DO** loop, no iteration of the loop can interfere with any other iteration. Interference occurs in the following situations:



- Two operations that define, undefine, or redefine the same atomic object (data that has no subobjects) interfere, unless the parent object appears in the **NEW** clause or **REDUCTION** clause. You must define nested **DO** loop index variables in the **NEW** clause.
- Definition, undefinition, or redefinition of an atomic object interferes with any use of the value of the object. The exception is if the parent object appeared in the **NEW** clause or **REDUCTION** clause.
- Any operation that causes the association status of a pointer to become defined or undefined interferes with any reference to the pointer or any other operation that causes the association status to become defined or undefined.
- Transfer of control outside the **DO** loop or execution of an **EXIT**, **STOP**, or **PAUSE** statement interferes with all other iterations.
- If any two I/O operations associated with the same file or external unit interfere with each other. The exceptions to this rule are:
  - If the two I/O operations are two **INQUIRE** statements; or
  -  If the two I/O operations are accessing distinct areas of a stream access file; or  If the two I/O operations are accessing distinct records of a direct access file.
  - If the two I/O operations are accessing distinct records of a direct access file.
- A change in the allocation status of an allocatable object between iterations causes interference.

If the **NEW** clause is specified, the directive must apply to a **DO** loop. The **NEW** clause modifies the directive and any surrounding **INDEPENDENT** directives by accepting any assertions made by such directive(s) as true. It does this *even if* the variables specified in the **NEW** clause are modified by each iteration of the loop. Variables specified in the **NEW** clause behave as if they are private to the body of the **DO** loop. That is, the program is unaffected if these variables (and any variables associated with them) were to become undefined both before and after each iteration of the loop.

Any variable you specify in the **NEW** clause or **REDUCTION** clause must not:

- Be a dummy argument
- Be a pointee
- Be use-associated or host-associated
- Be a common block variable
- Have either the **SAVE** or **STATIC** attribute
- Have either the **POINTER** or **TARGET** attribute
- Appear in an **EQUIVALENCE** statement

For **FORALL**, no combination of index values affected by the **INDEPENDENT** directive assigns to an atomic storage unit that is required by another combination. If a **DO** loop, **FORALL** statement, or **FORALL** construct all have the same body and each is preceded by an **INDEPENDENT** directive, they behave the same way.

The **REDUCTION** clause asserts that updates to named variables will occur within **REDUCTION** statements in the **INDEPENDENT** loop. Furthermore, the intermediate values of the **REDUCTION** variables are not used within the parallel section, other than in the updates themselves. Thus, the value of the **REDUCTION** variable after the construct is the result of a reduction tree.

If you specify the **REDUCTION** clause, the directive must apply to a **DO** loop. The only reference to a **REDUCTION** variable in an **INDEPENDENT DO** loop must be within a reduction statement.

A **REDUCTION** variable must be of intrinsic type, but must not be of type character. A **REDUCTION** variable must not be an allocatable array.

A **REDUCTION** variable must not occur in:

- A **NEW** clause in the same **INDEPENDENT** directive
- A **NEW** or **REDUCTION** clause in an **INDEPENDENT** directive in the body of the following **DO** loop
- A **FIRSTPRIVATE**, **PRIVATE** or **LASTPRIVATE** clause in a **PARALLEL DO** directive in the body of the following **DO** loop
- A **PRIVATE** clause in a **PARALLEL SECTIONS** directive in the body of the following **DO** loop

A **REDUCTION** statement can have one of the following forms:

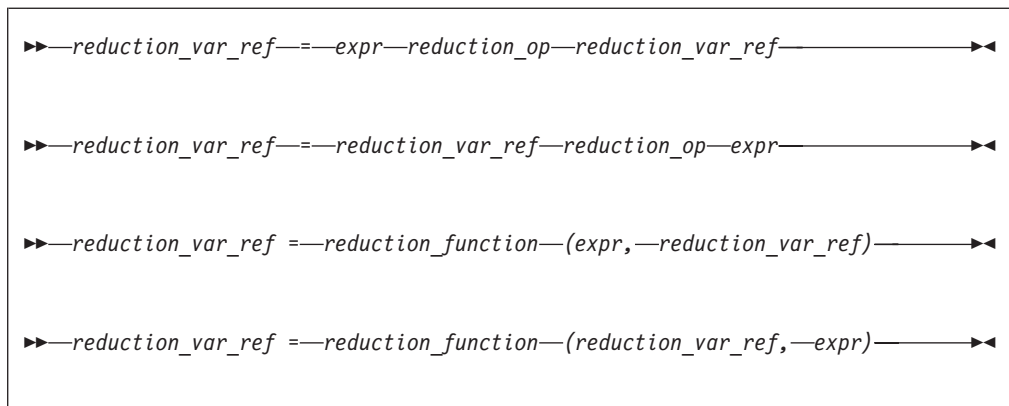

where:

*reduction\_var\_ref*

is a variable or subobject of a variable that appears in a **REDUCTION** clause

*reduction\_op*

is one of: **+**, **-**, **\***, **.AND.**, **.OR.**, **.EQV.**, **.NEQV.**, or **.XOR.**

*reduction\_function*

is one of: **MAX**, **MIN**, **IAND**, **IOR**, or **IEOR**

The following rules apply to **REDUCTION** statements:

1. A reduction statement is an assignment statement that occurs in the range of an **INDEPENDENT DO** loop. A variable in the **REDUCTION** clause must only occur in a **REDUCTION** statement within the **INDEPENDENT DO** loop.
2. The two *reduction\_var\_refs* that appear in a **REDUCTION** statement must be lexically identical.
3. The syntax of the **INDEPENDENT** directive does not allow you to designate an array element or array section as a **REDUCTION** variable in the **REDUCTION** clause. Although such a subobject may occur in a **REDUCTION** statement, it is the entire array that is treated as a **REDUCTION** variable.

4. You cannot use the following form of the **REDUCTION** statement:

```
►—reduction_var_ref— = —expr— - —reduction_var_ref—◄
```

## Examples

### Example 1:

```
INTEGER A(10),B(10,12),F
!IBM* INDEPENDENT                ! The NEW clause cannot be
FORALL (I=1:9:2) A(I)=A(I+1)    ! specified before a FORALL
!IBM* INDEPENDENT, NEW(J)
DO M=1,10
  J=F(M)                        ! 'J' is used as a scratch
  A(M)=J*J                      ! variable in the loop
!IBM* INDEPENDENT, NEW(N)
DO N=1,12                        ! The first executable statement
  B(M,N)=M*N*N                  ! following the INDEPENDENT must
END DO                          ! be either a DO or FORALL
END DO
END
```

### Example 2:

```
X=0
!IBM* INDEPENDENT, REDUCTION(X)
DO J = 1, M
  X = X + J**2
END DO
```

### Example 3:

```
INTEGER A(100), B(100, 100)
!IBM* INDEPENDENT, REDUCTION(A), NEW(J) ! Example showing an array used
DO I=1,100                               ! for a reduction variable
DO J=1, 100
  A(I)=A(I)+B(J, I)
END DO
END DO
```

## Related information

- “Loop parallelization” on page 357
- “DO construct” on page 131
- “FORALL” on page 355
- **-qdirective** in the *XL Fortran Compiler Reference*
- **-qhot** Option in the *XL Fortran Compiler Reference*
- **-qsmp** Option in the *XL Fortran Compiler Reference*

## #LINE

### Purpose

The **#line** directive associates code that is created by `cpp` or any other Fortran source code generator with input code created by the programmer. Because the preprocessor may cause lines of code to be inserted or deleted, the **#line** directive can be useful in error reporting and debugging because it identifies which lines in the original source caused the preprocessor to generate the corresponding lines in the intermediate file.

## Syntax

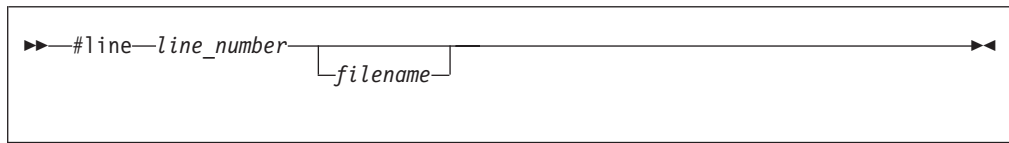

The **#line** directive is a noncomment directive and follows the syntax rules for this type of directive.

*line\_number*

is a positive, unsigned integer literal constant without a **KIND** parameter. You must specify *line\_number*.

*filename*

is a character literal constant, with no kind type parameter. The *filename* may specify a full or relative path. The *filename* as specified will be recorded for use later. If you specify a relative path, when you debug the program the debugger will use its directory search list to resolve the *filename*.

## Rules

The **#line** directive follows the same rules as other noncomment directives, with the following exceptions:

- You cannot have Inline comments on the same line as the **#line** directive.
- White space is optional between the **#** character and **line** in free source form.
- White space may not be embedded between the characters of the word **line** in fixed or free source forms.
- The **#line** directive can start anywhere on the line in fixed source form.

The **#line** directive indicates the origin of all code following the directive in the current file. Another **#line** directive will override a previous one.

If you supply a *filename*, the subsequent code in the current file will be as if it originated from that *filename*. If you omit the *filename*, and no previous **#line** directive with a specified *filename* exists in the current file, the code in the current file is treated as if it originated from the current file at the line number specified. If a previous **#line** directive with a specified *filename* does exist in the current file, the *filename* from the previous directive is used.

*line\_number* indicates the position, in the appropriate file, of the line of code following the directive. Subsequent lines in that file are assumed to have a one to one correspondence with subsequent lines in the source file until another **#line** directive is specified or the file ends.

When XL Fortran invokes `cpp` for a file, the preprocessor will emit **#line** directives unless you also specify the **-d** option.

## Examples

The file `test.F` contains:

```
! File test.F, Line 1
#include "test.h"
PRINT*, "test.F Line 3"
...
```

```

PRINT*, "test.F Line 6"
#include "test.h"
PRINT*, "test.F Line 8"
END

```

The file test.h contains:

```

! File test.h line 1
RRINT*,1          ! Syntax Error
PRINT*,2

```

After the C preprocessor processes the file test.F with the default options:

```

#line 1 "test.F"
! File test.F, Line 1
#line 1 "test.h"
! File test.h Line 1
RRINT*,1          ! Syntax Error
PRINT*,2
#line 3 "test.F"
PRINT*, "test.F Line 3"
...
#line 6
PRINT*, "test.F Line 6"
#line 1 "test.h"
! File test.h Line 1
RRINT*,1          ! Syntax Error
PRINT*,2
#line 8 "test.F"
PRINT*, "test.F Line 8"
END

```

The compiler displays the following messages after it processes the file that is created by the C preprocessor:

```

2      2 |RRINT*,1
!Syntax error
          .....a.....
a - "test.h", line 2.6: 1515-019 (S) Syntax is incorrect.

4      2 |RRINT*,1          !Syntax error
          .....a.....
a - "test.h", line 2.6: 1515-019 (S) Syntax is incorrect.

```

## Related information

- **-d** Option in the *XL Fortran Compiler Reference*
- *Passing Fortran Files through the C Preprocessor in the XL Fortran Compiler Reference*

## LOOPID

### Purpose

The **LOOPID** directive allows you to assign a unique identifier to loop within a scoping unit. You can use the identifier to direct loop transformations. The **-qreport** compiler option can use the identifier you create to provide reports on loop transformations.

### Syntax

```

▶▶—LOOPID—(—name—)————▶▶

```

**name** is an identifier that must be unique within the scoping unit.

### Rules

The **LOOPID** directive must immediately precede a **BLOCK\_LOOP** directive or **DO** construct.

You must not specify a **LOOPID** directive more than once for a given loop.

You must not specify a **LOOPID** directive for **DO** constructs without control statements, **DO WHILE** constructs, or an infinite **DO**.

### Related information

- For additional methods of optimizing loops, see the **BLOCK\_LOOP**, **STREAM UNROLL**, **UNROLL** and the **UNROLL\_AND\_FUSE** directives.

## MEM\_DELAY

### Purpose

The **MEM\_DELAY** directive specifies how many delay cycles there will be for specific loads, these specific loads are a delinquent loads.

A delinquent load has a long memory access latency due to cache misses.

When you specify which load is a delinquent load with **MEM\_DELAY** the compiler may take that information and carry out optimizations such as data prefetch.

### Syntax

►► **NEW**—(*delinquent\_variable*—, *cycles*—)—————►►

### *delinquent\_variable*

Any data item that can legally be passed by reference to a subprogram.

**cycles** 32-bit literal integer value or equivalent **PARAMETER**.

### Rules

The **MEM\_DELAY** directive is placed immediately before a statement which contains a specified memory reference.

*cycles* must be a compile time constant, typically either L1 miss latency or L2 miss latency.

### Examples

```
DO I=1,N
  !IBM* MEM_DELAY(B[N*I],10)
  A[I]=B[N*I];
END DO
```

## NEW

### Purpose

Use the **NEW** directive to specify which variables should be local in a **PARALLEL DO** loop or a **PARALLEL SECTIONS** construct. This directive performs the same function as the **PRIVATE** clause of the **PARALLEL DO** directive and **PARALLEL SECTIONS** directive.

## Class

The **NEW** directive only takes effect if you specify the **-qsmp** compiler option.

## Syntax

▶▶—NEW—*named\_variable\_list*—▶▶

## Rules

The **NEW** directive must immediately follow either a **PARALLEL DO** directive or a **PARALLEL SECTIONS** directive.

If you specify the **NEW** directive, you must specify the corresponding **PARALLEL DO** or **PARALLEL SECTIONS** directive with no clauses.

If the **NEW** directive follows the **PARALLEL DO** directive, the first noncomment line (not including other directives) following the **NEW** directive must be a **DO** loop. This line cannot be an infinite **DO** or **DO WHILE** loop.

A variable name in the *named\_variable\_list* of the **NEW** directive has the same restrictions as a variable name appearing in the **PRIVATE** clause of the **PARALLEL DO** directive or a **PRIVATE** clause of the **PARALLEL SECTIONS** directive. See the sections on the **PARALLEL DO** directive and the **PARALLEL SECTIONS** construct in the *XL Fortran Optimization and Programming Guide*.

## Examples

```
INTEGER A(10), C(10)
REAL B(10)
INTEGER FUNC(100)
!SMP$ PARALLEL DO
!SMP$ NEW I, TMP
  DO I = 1, 10
    TMP = A(I) + COS(B(I))
    C(I) = TMP + FUNC(I)
  END DO
```

## NOVECTOR

### Purpose

The **NOVECTOR** directive prohibits the compiler from auto-vectorizing the loop immediately following the directive. Auto-vectorization involves converting certain operations performed in a loop and on successive array elements into a call to a routine that computes several results simultaneously.

### Syntax

▶▶—NOVECTOR—▶▶

### Rules

The first noncomment line (not including other directives) following the **NOVECTOR** directive must be a **DO** loop, **FORALL** statement, or a **FORALL** construct. This line cannot be an infinite **DO** or **DO WHILE** loop. The **NOVECTOR** directive applies only to the **DO** loop, **FORALL** statement or the

**FORALL** construct that is immediately following the directive and does not apply to any nested **DO** loops, or nested **FORALL** construct or statement.

You can use the **NOVECTOR** directive together with loop optimization and SMP directives.

### Examples

```
SUBROUTINE VEC (A, B)
  REAL*8 A(200), B(200)
  !IBM* NOVECTOR
  DO N = 1, 200
    B(N) = B(N) / A(N)
  END DO
END SUBROUTINE
```

### Related information

Refer to the **-qhot=vector** compiler option for information on controlling auto-vectorization for an entire application.

## PERMUTATION

### Purpose

The **PERMUTATION** directive specifies that the elements of each array that is listed in the *integer\_array\_name\_list* have no repeated values. This directive is useful when you use array elements as subscripts for other array references.

The **PERMUTATION** directive only takes effect if you specify either the **-qsmp** or **-qhot** compiler option.

### Syntax

```
▶▶—PERMUTATION—(—integer_array_name_list—)————▶▶
```

*integer\_array\_name*  
is an integer array with no repeated values.

### Rules

The first noncomment line (not including other directives) that is following the **PERMUTATION** directive must be a **DO** loop. This line cannot be an infinite **DO** or **DO WHILE** loop. The **PERMUTATION** directive applies only to the **DO** loop that is immediately following the directive, and not to any nested **DO** loops.

### Examples

```
PROGRAM EX3
  INTEGER A(100), B(100)
  !IBM* PERMUTATION (A)
  DO I = 1, 100
    A(I) = I
    B(A(I)) = B(A(I)) + A(I)
  END DO
END PROGRAM EX3
```

### Related information

- **-qhot** Option in the *XL Fortran Compiler Reference*
- **-qsmp** Option in the *XL Fortran Compiler Reference*



- DO

## @PROCESS

### Purpose

The **@PROCESS** directive allows you to specify at the source level that a compiler option affects only an individual compilation unit. The directive can override options that you include in the configuration file, in the default settings, or on the command line. Refer to the *XL Fortran Compiler Reference* for information on limitations or restrictions for specifying a particular compiler option at the source level.

### Syntax

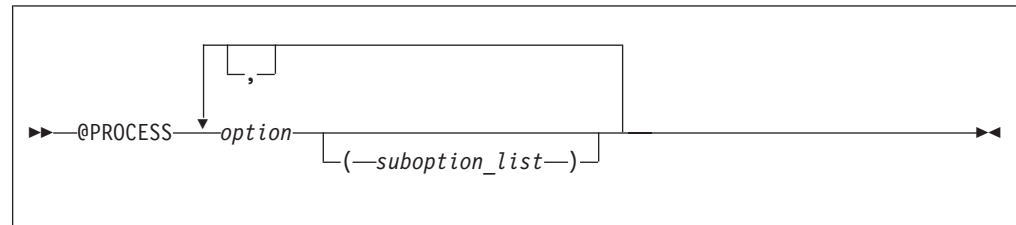

*option* is the name of a compiler option, without **-q**

*suboption*

is a suboption of a compiler option

### Rules

In fixed source form, the **@PROCESS** directive can start in column 1 or after column 6. In free source form, the **@PROCESS** directive can start in any column.

You cannot place a statement label or inline comment on the same line as an **@PROCESS** compiler directive.

By default, any option settings you designate with the **@PROCESS** compiler directive are effective only for the compilation unit in which the statement appears. If the file has more than one compilation unit, the option returns to the original setting before compilation of the text unit. Trigger constants you specify using the **DIRECTIVE** option are in effect until the end of the file, or until processing **NODIRECTIVE**.

The **@PROCESS** compiler directive must appear before the first statement of a compilation unit. The only exceptions are for **SOURCE** and **NOSOURCE** compiler options, which you can specify in **@PROCESS** directives anywhere within the compilation unit.

### Related information

See *Compiler Option Details* in the *XL Fortran Compiler Reference* for details on compiler options.

## SNAPSHOT

### Purpose

You can use the **SNAPSHOT** directive to specify a safe location where a breakpoint can be set with a debug program, and provide a set of variables that

must remain visible to the debug program. The **SNAPSHOT** directive provides support for the **-qsmp** compiler option, though you can use it in a non-multi-threaded program.

There can be a small reduction in performance at the point where the **SNAPSHOT** directive is set, because the variables must be kept in memory for the debug program to access. Variables made visible by the **SNAPSHOT** directive are read-only. Undefined behavior will occur if these variables are modified through the debugger. Use with discretion.

At high optimization levels, the **SNAPSHOT** directive does not consistently preserve the contents of variables with a static storage class.

## Syntax

```
▶▶—SNAPSHOT—(—named_variable_list—)————▶▶
```

*named\_variable*

is a named variable that must be accessible in the current scope.

## Rules

To use the **SNAPSHOT** directive, you must specify the **-qdbg** compiler option at compilation.

## Examples

**Example 1:** In the following example, the **SNAPSHOT** directive is used to monitor the value of private variables.

```

    INTEGER :: IDX
    INTEGER :: OMP_GET_NUM_THREADS, OMP_GET_THREAD_NUM
    INTEGER, ALLOCATABLE :: ARR(:)
!
    ...

!$OMP PARALLEL, PRIVATE(IDX)
!$OMP MASTER
    ALLOCATE(ARR(OMP_GET_NUM_THREADS()))
!$OMP END MASTER
!$OMP BARRIER

    IDX = OMP_GET_THREAD_NUM() + 1

!IBM* SNAPSHOT(IDX)                ! The PRIVATE variable IDX is made visible
                                   ! to the debugger.

    ARR(IDX) = 2*IDX + 1

!$OMP END PARALLEL

```

**Example 2:** In the following example, the **SNAPSHOT** directive is used to monitor the intermediate values in debugging the program.

```

SUBROUTINE SHUFFLE(NTH, XDAT)
    INTEGER, INTENT(IN) :: NTH
    REAL, INTENT(INOUT) :: XDAT(:)
    INTEGER :: I_TH, IDX, PART(1), I, J, LB, UB
    INTEGER :: OMP_GET_THREAD_NUM
    INTEGER(8) :: Y=1
    REAL :: TEMP

    CALL OMP_SET_NUM_THREADS(NTH)

```

```

PART = UBOUND(XDAT)/NTH

!$OMP PARALLEL, PRIVATE(NUM_TH, I, J, LB, UB, IDX, TEMP), SHARED(XDAT)
NUM_TH = OMP_GET_THREAD_NUM() + 1
LB = (NUM_TH - 1)*PART(1) + 1
UB = NUM_TH*PART(1)

DO I=LB, UB
!$OMP CRITICAL
Y = MOD(65539_8*y, 2_8**31)
IDX = INT(REAL(Y)/REAL(2_8**31))*(UB - LB) + LB

!SMP$ SNAPSHOT(i, y, idx, num_th, lb, ub)

!$OMP END CRITICAL
TEMP = XDAT(I)
XDAT(I) = XDAT(IDX)
XDAT(IDX) = TEMP
ENDDO

!SMP$ SNAPSHOT(TEMP) ! The user can examine the value
! of the TEMP variable

!$OMP END PARALLEL
END

```

## Related information

See the *XL Fortran Compiler Reference* for details on the **-qdbg** compiler option.

## SOURCEFORM

### Purpose

The **SOURCEFORM** compiler directive indicates that all subsequent lines are to be processed in the specified source form until the end of the file is reached or until an **@PROCESS** directive or another **SOURCEFORM** directive specifies a different source form.

### Syntax

▶—SOURCEFORM—(—*source*—)————▶

*source* is one of the following: **FIXED**, **FIXED(right\_margin)**, **FREE(F90)**, **FREE(IBM)**, or **FREE**. **FREE** defaults to **FREE(F90)**.

*right\_margin*

is an unsigned integer specifying the column position of the right margin. The default is 72. The maximum is 132.

### Rules

The **SOURCEFORM** directive can appear anywhere within a file. An include file is compiled with the source form of the including file. If the **SOURCEFORM** directive appears in an include file, the source form reverts to that of the including file once processing of the include file is complete.

The **SOURCEFORM** directive cannot specify a label.



## Rules

You must specify one of the following compiler options to enable loop unrolling:

- **-O3** or higher optimization level
- **-qhot**
- **-qsmp**

Note that if the **-qstrict** option is in effect, no stream unrolling will occur. If you want to enable stream unrolling with the **-qhot** option alone, you must also specify **-qnostrict**.

The **STREAM\_UNROLL** directive must immediately precede a **DO** loop.

You must not specify the **STREAM\_UNROLL** directive more than once, or combine the directive with **UNROLL**, **NOUNROLL**, **UNROLL\_AND\_FUSE**, or **NOUNROLL\_AND\_FUSE** directives for the same **DO** construct.

You must not specify the **STREAM\_UNROLL** directive for a **DO WHILE** loop or an infinite **DO** loop.

## Examples

The following is an example of how **STREAM\_UNROLL** can increase performance.

```
integer, dimension(1000) :: a, b, c
integer i, m, n

!IBM* stream_unroll(4)
do i = 1, n
  a(i) = b(i) + c(i)
enddo
end
```

An *unroll factor* reduces the number of iterations from  $n$  to  $n/4$ , as follows:

```
m = n/4
do i = 1, n/4
  a(i) = b(i) + c(i)
  a(i+m) = b(i+m) + c(i+m)
  a(i+2*m) = b(i+2*m) + c(i+2*m)
  a(i+3*m) = b(i+3*m) + c(i+3*m)
enddo
```

The increased number of read and store operations are distributed among a number of streams determined by the compiler, reducing computation time and boosting performance.

## Related information

- For further information on using prefetch techniques in XL Fortran see the **PREFETCH** directive set.
- For additional methods on optimizing loops, see the **BLOCK\_LOOP**, **LOOPID**, **UNROLL** and the **UNROLL\_AND FUSE** directives.

## SUBSCRIPTORDER

### Purpose

The **SUBSCRIPTORDER** directive rearranges the subscripts of an array. This results in a new array shape, since the directive changes the order of array dimensions in the declaration. All references to the array are correspondingly rearranged to match the new array shape.

Used with discretion, the **SUBSCRIPTORDER** directive may improve performance by increasing the number of cache hits and the amount of data prefetching. You may have to experiment with this directive until you find the arrangement that yields the most performance benefits. You may find **SUBSCRIPTORDER** especially useful when porting code originally intended for a non-cached hardware architecture.

In a cached hardware architecture, such as the PowerPC, an entire cache line of data is often loaded into the processor in order to access each data element. Changing the storage arrangement can be used to ensure that consecutively accessed elements are stored contiguously. This may result in a performance improvement, as there are more element accesses for each cache line referenced. Additionally, contiguous arrays which are consecutively accessed may help to better exploit the processor's prefetching facility.

## Syntax

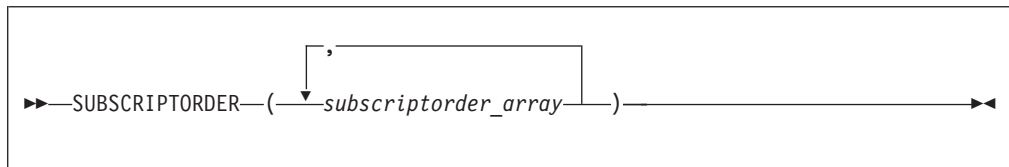

where *subscriptorder\_array* is:

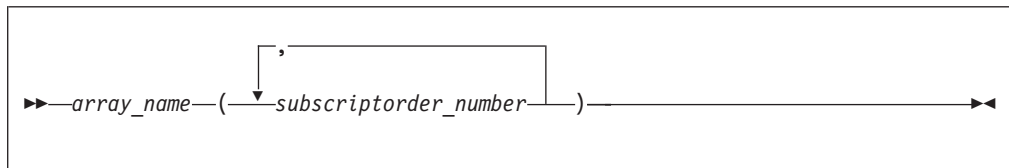

*array name*

is the name of an array.

*subscriptorder\_number*

is an integer constant.

## Rules

The **SUBSCRIPTORDER** directive must appear in a scoping unit preceding all declarations and references to the arrays in the *subscriptorder\_array* list. The directive only applies to that scoping unit and must contain at least one array. If multiple scoping units share an array, then you must apply the **SUBSCRIPTORDER** directive to each of the applicable scoping units with identical subscript arrangements. Examples of methods of array sharing between scoping units include **COMMON** statements, **USE** statements, and subroutine arguments.

The lowest subscript number in a *subscriptorder\_number* list must be 1. The highest number must be equal to the number of dimensions in the corresponding array. Every integer number between these two limits, including the limits, signifies a subscript number prior to rearrangement and must be included exactly once in the list.

You must not apply a **SUBSCRIPTORDER** directive multiple times to a particular array in a scoping unit.

You must maintain array shape conformance in passing arrays as actual arguments to elemental procedures, if one of the arrays appears in a **SUBSCRIPTORDER** directive. You must also adjust the actual arguments of the **SHAPE**, **SIZE**, **LBOUND**, and **UBOUND** inquiry intrinsic procedures and of most transformational intrinsic procedures.

You must manually modify data in input data files and in explicit initializations for arrays that appear in the **SUBSCRIPTORDER** directive.

On arrays to which the **COLLAPSE** directive is also applied, the **COLLAPSE** directive always refers to the pre-subscriptorder dimension numbers.

You must not rearrange the last dimension of an assumed-size array.

## Examples

**Example 1:** In the following example, the **SUBSCRIPTORDER** directive is applied to an explicit-shape array and swaps the subscripts in every reference to the array, without affecting the program output.

```
!IBM* SUBSCRIPTORDER(A(2,1))
      INTEGER COUNT/1/, A(3,2)

      DO J = 1, 3
        DO K = 1, 2
          ! Inefficient coding: innermost index is accessing rightmost
          ! dimension. The subscriptorder directive compensates by
          ! swapping the subscripts in the array's declaration and
          ! access statements.
          !
          A(J,K) = COUNT
          PRINT*, J, K, A(J,K)

          COUNT = COUNT + 1
        END DO
      END DO
```

Without the directive above, the array shape is (3,2) and the array elements would be stored in the following order:

```
A(1,1) A(2,1) A(3,1) A(1,2) A(2,2) A(3,2)
```

With the directive, the array shape is (2,3) and the array elements are stored in the following order:

```
A(1,1) A(2,1) A(1,2) A(2,2) A(1,3) A(2,3)
```

## Related information

For more information on the **COLLAPSE** directive, see “**COLLAPSE**” on page 497

# UNROLL

## Purpose

The **UNROLL** directive instructs the compiler to attempt loop unrolling where applicable. Loop unrolling replicates the body of the **DO** loop to reduce the number of iterations required to complete the loop.

You can control loop unrolling for an entire file using the **-qunroll** compiler option. Specifying the directive for a particular **DO** loop always overrides the compiler option.

## Syntax

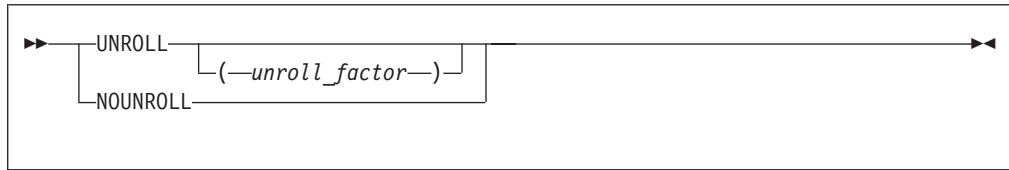

### *unroll\_factor*

The *unroll\_factor* must be a positive scalar integer initialization expression. An *unroll\_factor* of 1 disables loop unrolling. If you do not specify an *unroll\_factor*, loop unrolling is compiler determined.

## Rules

You must specify one of the following compiler options to enable loop unrolling:

- **-O3** or higher optimization level
- **-qhot**
- **-qsmp**

Note that if the **-qstrict** option is in effect, no loop unrolling will occur. If you want to enable loop unrolling with the **-qhot** option alone, you must also specify **-qnostrict**.

The **UNROLL** directive must immediately precede a **DO** loop.

You must not specify the **UNROLL** directive more than once, or combine the directive with **NOUNROLL**, **STREAM\_UNROLL**, **UNROLL\_AND\_FUSE**, or **NOUNROLL\_AND\_FUSE** directives for the same **DO** construct.

You must not specify the **UNROLL** directive for a **DO WHILE** loop or an infinite **DO** loop.

## Examples

**Example 1:** In this example, the **UNROLL(2)** directive is used to tell the compiler that the body of the loop can be replicated so that the work of two iterations is performed in a single iteration. Instead of performing 1000 iterations, if the compiler unrolls the loop, it will only perform 500 iterations.

```
!IBM* UNROLL(2)
      DO I = 1, 1000
         A(I) = I
      END DO
```

If the compiler chooses to unroll the previous loop, the compiler translates the loop so that it is essentially equivalent to the following:

```
      DO I = 1, 1000, 2
         A(I) = I
         A(I+1) = I + 1
      END DO
```

**Example 2:** In the first **DO** loop, **UNROLL(3)** is used. If unrolling is performed, the compiler will unroll the loop so that the work of three iterations is done in a single iteration. In the second **DO** loop, the compiler determines how to unroll the loop for maximum performance.

```
PROGRAM GOODUNROLL

      INTEGER I, X(1000)
```



```

REAL A, B, C, TEMP, Y(1000)

!IBM* UNROLL(3)
DO I = 1, 1000
  X(I) = X(I) + 1
END DO

!IBM* UNROLL
DO I = 1, 1000
  A = -I
  B = I + 1
  C = I + 2
  TEMP = SQRT(B*B - 4*A*C)
  Y(I) = (-B + TEMP) / (2*A)
END DO
END PROGRAM GOODUNROLL

```

## Related information

- For additional methods of optimizing loops, see the **BLOCK\_LOOP**, **LOOPID**, **STREAM UNROLL** and the **UNROLL\_AND\_FUSE** directives.

## UNROLL\_AND\_FUSE

### Purpose

The **UNROLL\_AND\_FUSE** directive instructs the compiler to attempt a loop unroll and fuse where applicable. Loop unrolling replicates the body of multiple **DO** loops and combines the necessary iterations into a single unrolled loop. Using a fused loop can minimize the required number of loop iterations, while reducing the frequency of cache misses. Applying the **UNROLL\_AND\_FUSE** directive to a loop with dependencies will produce unexpected results.

### Syntax

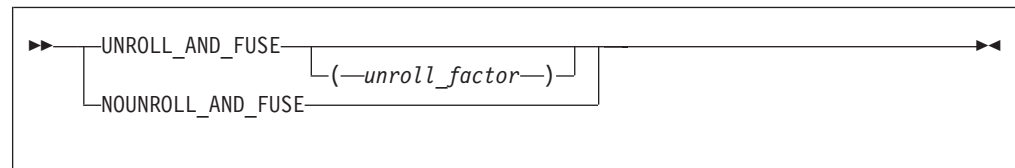

### *unroll\_factor*

The *unroll\_factor* must be a positive scalar integer initialization expression. An *unroll\_factor* of 1 disables loop unrolling. If you do not specify an *unroll\_factor*, loop unrolling is compiler determined.

### Rules

You must specify one of the following compiler options to enable loop unrolling:

- **-O3** or higher optimization level
- **-qhot**
- **-qsmp**

Note that if the **-qstrict** option is in effect, no loop unrolling will occur. If you want to enable loop unrolling with the **-qhot** option alone, you must also specify **-qnostrict**.

The **UNROLL\_AND\_FUSE** directive must immediately precede a **DO** loop.

You must not specify the **UNROLL\_AND\_FUSE** directive for the innermost **DO** loop.

You must not specify the `UNROLL_AND_FUSE` directive more than once, or combine the directive with `NOUNROLL_AND_FUSE`, `NOUNROLL`, `UNROLL`, or `STREAM_UNROLL` directives for the same `DO` construct.

You must not specify the `UNROLL_AND_FUSE` directive for a `DO WHILE` loop or an infinite `DO` loop.

## Examples

**Example 1:** In the following example, the `UNROLL_AND_FUSE` directive replicates and fuses the body of the loop. This reduces the number of cache misses for Array *B*.

```
      INTEGER, DIMENSION(1000, 1000) :: A, B, C
!IBM* UNROLL_AND_FUSE(2)
      DO I = 1, 1000
        DO J = 1, 1000
          A(J,I) = B(I,J) * C(J,I)
        END DO
      END DO
      END
```

The `DO` loop below shows a possible result of applying the `UNROLL_AND_FUSE` directive.

```
      DO I = 1, 1000, 2
        DO J = 1, 1000
          A(J,I) = B(I,J) * C(J,I)
          A(J,I+1) = B(I+1, J) * C(J, I+1)
        END DO
      END DO
```

**Example 2:** The following example uses multiple `UNROLL_AND_FUSE` directives:

```
      INTEGER, DIMENSION(1000, 1000) :: A, B, C, D, H
!IBM* UNROLL_AND_FUSE(4)
      DO I = 1, 1000
!IBM* UNROLL_AND_FUSE(2)
        DO J = 1, 1000
          DO k = 1, 1000
            A(J,I) = B(I,J) * C(J,I) + D(J,K)*H(I,K)
          END DO
        END DO
      END DO
      END
```

## Related information

- For additional methods of optimizing loops, see the `BLOCK_LOOP`, `LOOPID`, `STREAM_UNROLL` and the `UNROLL` directives.

End of IBM Extension

---

## Chapter 13. Hardware-specific directives

This section provides an alphabetical reference to hardware-specific compiler directives. Unless otherwise noted, a directive will function on any supported hardware. This section contains the following directives:

"CACHE_ZERO"	"DCBFL"	"LIGHT_SYNC" on page 520
"ISYNC" on page 520	"PREFETCH" on page 521	
"PROTECTED_STREAM" on page 524		

---

### CACHE\_ZERO

#### Purpose

The **CACHE\_ZERO** directive invokes the machine instruction, data cache block set to zero (dcbz). This instruction sets the data cache block corresponding to the variables you specify to zero. Use this directive with discretion.

#### Syntax

```
▶▶—CACHE_ZERO—(—cv_var_list—)————▶▶
```

*cv\_var* is a variable associated with the cache block that is set to zero. The variable must be a data object with a determinable storage address. The variable cannot be a procedure name, subroutine name, module name, function name, constant, label, zero-sized string, or an array with vector subscripts.

#### Examples

In the following example, assume that array *ARRA* has already been loaded into a cache block that you want to set to zero. The data in the cache block is then set to zero.

```
real(4) :: arrA(2**5)
! ....
!IBM* CACHE_ZERO(arrA(1))           ! set data in cache block to zero
```

---

### DCBFL

#### Purpose

- The **DCBFL** directive will flush the cache line at the specified prefetch variable from the L1 data cache only and ensures that the latest version of the target storage block is still in L2 but no longer in L1.

#### Syntax

```
▶▶ DCBFL (—prefetch_variable—) ▶▶
```

*prefetch\_variable*

the L1 cache line specified by the prefetch variable to be flushed

---

## EIEIO

### Purpose

Enforce In-order Execution of Input/Output (EIEIO).

The **EIEIO** directive allows you to specify that all I/O storage access instructions preceding the directive complete before any I/O access instruction subsequent to the directive can begin. Use **EIEIO** when managing shared data instruction where the execution order of load/store access is significant.

**EIEIO** can provide the necessary functionality for controlling I/O stores without the cost to performance that can occur with other synchronization instructions.

### Syntax

```
▶▶ EIEIO ▶▶
```

---

## ISYNC

### Purpose

The **ISYNC** directive enables you to discard any prefetched instructions after all preceding instructions complete. Subsequent instructions are fetched or refetched from storage and execute in the context of previous instructions. The directive only affects the processor that executes **ISYNC**.

### Syntax

```
▶▶ ISYNC ▶▶
```

---

## LIGHT\_SYNC

### Purpose

The **LIGHT\_SYNC** directive ensures that all stores prior to **LIGHT\_SYNC** complete before any new instructions can be executed on the processor that executed the **LIGHT\_SYNC** directive. This allows you to synchronize between multiple processors with minimal performance impact, as **LIGHT\_SYNC** does not wait for confirmation from each processor.

## Syntax

```
▶▶—LIGHT_SYNC————▶▶
```

---

## PREFETCH

### Purpose

You can use prefetching to instruct the compiler to load specific data from main memory into the cache before the data is referenced. Some prefetching can be done automatically by hardware that is POWER3™ and above, but since compiler-assisted software prefetching can use information directly from your source code, specifying the directive can significantly reduce the number of cache misses.

XL Fortran provides the following directives for compiler-assisted software prefetching:

- The **PREFETCH\_BY\_LOAD** directive prefetches data into the cache by way of a load instruction. **PREFETCH\_BY\_LOAD** can be used on any machine, but if you are running on a POWER3 or higher machine, **PREFETCH\_BY\_LOAD** enables hardware-assisted prefetching.
- The **PREFETCH\_BY\_STREAM** prefetch technique uses the POWER4 prefetch engine to recognize sequential access to adjacent cache lines and then requests anticipated lines from deeper levels of the memory hierarchy. This technique establishes a path or stream as repeated references to main memory are made, increasing the depth of the prefetch until enough lines are loaded into the cache. To fetch data from decremental memory addresses, use the **PREFETCH\_BY\_STREAM\_BACKWARD** directive. To fetch data from incremental memory addresses, use the **PREFETCH\_BY\_STREAM\_FORWARD** directive. The use of this streamed prefetch to load data from main memory into the cache can reduce or eliminate load latency.
- The **PREFETCH\_FOR\_LOAD** directive prefetches data into the cache for reading by way of a cache prefetch instruction.
- The **PREFETCH\_FOR\_STORE** directive prefetches data into the cache for writing by way of a cache prefetch instruction.

### Syntax

The **PREFETCH** directive can take the following forms:

```
▶▶—PREFETCH_BY_LOAD—(—prefetch_variable_list—)————▶▶
```

```
▶▶—PREFETCH_FOR_LOAD—(—prefetch_variable_list—)————▶▶
```

```
▶▶—PREFETCH_FOR_STORE—(—prefetch_variable_list—)————▶▶
```

```
▶▶—PREFETCH_BY_STREAM_BACKWARD—(—prefetch_variable—)————▶▶
```

```
▶▶—PREFETCH_BY_STREAM_FORWARD—(—prefetch_variable—)————▶▶
```

*prefetch\_variable*

is a variable to be prefetched. The variable must be a data object with a determinable storage address. The variable can be of any data type, including intrinsic and derived data types. The variable cannot be a procedure name, subroutine name, module name, function name, constant, label, zero-sized string, or an array with a vector subscript.

## Rules

When you prefetch a variable, the memory block that includes the variable address is loaded into the cache. A memory block is equal to the size of a cache line. Since the variable you are loading into the cache may appear anywhere within the memory block, you may not be able to prefetch all the elements of an array.

These directives may appear anywhere in your source code where executable constructs may appear.

These directives can add run-time overhead to your program. Therefore you should use the directives only where necessary.

To maximize the effectiveness of the prefetch directives, it is recommended that you specify the **LIGHT\_SYNC** directive after a single prefetch or at the end of a series of prefetches.

## Examples

**Example 1:** This example shows valid uses of the **PREFETCH\_BY\_LOAD**, **PREFETCH\_FOR\_LOAD**, and **PREFETCH\_FOR\_STORE** directives.

For this example, assume that the size of the cache line is 64 bytes and that none of the declared data items exist in the cache at the beginning of the program. The rationale for using the directives is as follows:

- All elements of array *ARRA* will be assigned; therefore, you can use the **PREFETCH\_FOR\_STORE** directive to bring the first 16 and second 16 elements of the array into the cache before they are referenced.
- Since all elements of array *ARRC* will be read, you can use the **PREFETCH\_FOR\_LOAD** directive to bring the first 16 and second 16 elements of the array into the cache before they are referenced. (Assume that the elements have been initialized first.)
- Each iteration of the loop will use variables *A*, *B*, *C*, *TEMP*, *I*, *K* and array element *ARRB(I\*32)*; you can use the **PREFETCH\_BY\_LOAD** directive to load

the variables and the array into the cache. (Because of the size of the cache line, you will fetch 16 elements of *ARRB*, starting at element *ARRB(I\*32)*).

```

PROGRAM GOODPREFETCH

REAL*4 A, B, C, TEMP
REAL*4 ARRA(2**5), ARRB(2**10), ARRC(2**5)
INTEGER(4) I, K

! Bring ARRA into cache for writing.
!IBM* PREFETCH_FOR_STORE (ARRA(1), ARRA(2**4+1))

! Bring ARRC into cache for reading.
!IBM* PREFETCH_FOR_LOAD (ARRC(1), ARRC(2**4+1))

! Bring all variables into the cache.
!IBM* PREFETCH_BY_LOAD (A, B, C, TEMP, I , K)

! A subroutine is called to allow clock cycles to pass so that the
! data is loaded into the cache before the data is referenced.
CALL FOO()
K = 32
DO I = 1, 2 ** 5

! Bring ARRB(I*K) into the cache
!IBM* PREFETCH_BY_LOAD (ARRB(I*K))
  A = -I
  B = I + 1
  C = I + 2
  TEMP = SQRT(B*B - 4*A*C)
  ARRA(I) = ARRC(I) + (-B + TEMP) / (2*A)
  ARRB(I*K) = (-B - TEMP) / (2*A)
END DO
END PROGRAM GOODPREFETCH

```

**Example 2:** In this example, assume that the total cache line's size is 256 bytes, and that none of the declared data items are initially stored in the cache or register. All elements of array *ARRA* and *ARRC* will then be read into the cache.

```

PROGRAM PREFETCH_STREAM

REAL*4 A, B, C, TEMP
REAL*4 ARRA(2**5), ARRC(2**5), ARRB(2**10)
INTEGER*4 I, K

! All elements of ARRA and ARRC are read into the cache.
!IBM* PREFETCH_BY_STREAM_FORWARD(ARRA(1))
! You can substitute PREFETCH_BY_STREAM_BACKWARD (ARRC(2**5)) to read all
! elements of ARRA and ARRC into the cache.
K = 32
DO I = 1, 2**5
  A = -i
  B = i + 1
  C = i + 2
  TEMP = SQRT(B*B -4*A*C)
  ARRA(I) = ARRC(I) + (-B + TEMP) / (2*A)
  ARRB(I*K) = (-B -TEMP) / (2*A)
END DO
END PROGRAM PREFETCH_STREAM

```

## Related information

For information on applying prefetch techniques to loops with a large iteration count, see the **STREAM\_UNROLL** directive.

---

## PROTECTED STREAM

### Purpose

The **PROTECTED STREAM** directives allow you to manage protected streams. These streams are protected from being replaced by any hardware-detected streams.

XL Fortran provides the following protected stream directives:

- The **PROTECTED\_UNLIMITED\_STREAM\_SET\_GO\_FORWARD** directive establishes an unlimited-length protected stream that begins with the cache line at the specified prefetch variable and fetches from increasing memory addresses. The **PROTECTED\_UNLIMITED\_STREAM\_SET\_GO\_BACKWARD** directive fetches from decreasing memory addresses.
- The **PROTECTED\_STREAM\_SET\_FORWARD** directive establishes a limited-length protected stream that begins with the cache line at the specified prefetch variable and fetches from increasing memory addresses. The **PROTECTED\_STREAM\_SET\_BACKWARD** directive fetches from decreasing memory addresses.
- The **PROTECTED\_STREAM\_COUNT** directive sets the number of cache lines for the specified limited-length stream.
- The **PROTECTED\_STREAM\_GO** directive starts to prefetch all limited-length streams.
- The **PROTECTED\_STREAM\_STOP** directive stops prefetching the specified protected stream.
- The **PROTECTED\_STREAM\_STOP\_ALL** directive stops prefetching all protected streams.

POWER6™ extends stream prefetch to support store stream prefetch and prefetch depth control. It also adds a variant of dcbf that flushes the specified block from L1 cache but not from lower level caches.

- The **PROTECTED\_UNLIMITED\_STREAM\_SET\_FORWARD** directive establishes an unlimited-length protected stream that begins with the cache line at the specified prefetch variable and fetches from increasing memory addresses. The **PROTECTED\_UNLIMITED\_STREAM\_SET\_BACKWARD** directive fetches from decreasing memory addresses.
- The **PROTECTED\_UNLIMITED\_STORE\_STREAM\_SET\_FORWARD** directive establishes an unlimited-length protected store stream that begins with the cache line at the specified prefetch variable and fetches from increasing memory addresses. The **PROTECTED\_UNLIMITED\_STORE\_STREAM\_SET\_BACKWARD** directive fetches from decreasing memory addresses.
- The **PROTECTED\_STORE\_STREAM\_SET\_FORWARD** directive establishes a limited-length protected store stream that begins with the cache line at the specified prefetch variable and fetches from increasing memory addresses. The **PROTECTED\_STORE\_STREAM\_SET\_BACKWARD** directive fetches from decreasing memory addresses.
- The **PROTECTED\_STREAM\_COUNT\_DEPTH** directive sets the number of cache lines and the prefetch depth for the specified limited-length stream.

### Syntax

The **PROTECTED** directive can take the following forms:



▶▶—PROTECTED\_UNLIMITED\_STREAM\_SET\_GO\_FORWARD—(—*prefetch\_variable*—,—*stream\_ID*—)————▶▶

**Note:** Valid for PowerPC 970 and POWER5™.

▶▶—PROTECTED\_UNLIMITED\_STREAM\_SET\_GO\_BACKWARD—(—*prefetch\_variable*—,—*stream\_ID*—)————▶▶

**Note:** Valid for PowerPC 970 and POWER5.

▶▶—PROTECTED\_UNLIMITED\_STREAM\_SET\_FORWARD—(—*prefetch\_variable*—,—*stream\_ID*—)————▶▶

**Note:** Valid for POWER5 and POWER6 .

▶▶—PROTECTED\_UNLIMITED\_STREAM\_SET\_BACKWARD—(—*prefetch\_variable*—,—*stream\_ID*—)————▶▶

**Note:** Valid for POWER5 and POWER6 .

▶▶—PROTECTED\_STREAM\_SET\_FORWARD—(—*prefetch\_variable*—,—*stream\_ID*—)————▶▶

**Note:** Valid for POWER5 and POWER6 .

▶▶—PROTECTED\_STREAM\_SET\_BACKWARD—(—*prefetch\_variable*—,—*stream\_ID*—)————▶▶

**Note:** Valid for POWER5 and POWER6 .

▶▶—PROTECTED\_UNLIMITED\_STORE\_STREAM\_SET\_FORWARD—(—*prefetch\_variable*—,—*stream\_ID*—)————▶▶

**Note:** Valid for POWER6 only.

▶▶—PROTECTED\_UNLIMITED\_STORE\_STREAM\_SET\_BACKWARD—(—*prefetch\_variable*—,—*stream\_ID*—)————▶▶

**Note:** Valid for POWER6 only.

▶▶—PROTECTED\_STORE\_STREAM\_SET\_FORWARD—(—*prefetch\_variable*—,—*stream\_ID*—)————▶▶

**Note:** Valid for POWER6 only.

▶▶—PROTECTED\_STORE\_STREAM\_SET\_BACKWARD—(*—prefetch\_variable—*,*—stream\_ID—*)————▶▶

▶▶—PROTECTED\_STREAM\_COUNT—(*—unit\_count—*,*—stream\_ID—*)————▶▶

**Note:** Valid for POWER5 and POWER6 .

▶▶—PROTECTED\_STREAM\_COUNT\_DEPTH—(*—unit\_count—*,*—prefetch\_depth—*,*—stream\_id—*)————▶▶

**Note:** Valid for POWER6.

▶▶—PROTECTED\_STREAM\_GO————▶▶

**Note:** Valid for POWER5 and POWER6 .

▶▶—PROTECTED\_STREAM\_STOP—(*—stream\_ID—*)————▶▶

**Note:** Valid for POWER5 and POWER6 .

▶▶—PROTECTED\_STREAM\_STOP\_ALL————▶▶

**Note:** Valid for POWER5 and POWER6 .

*prefetch\_variable*

is a variable to be prefetched. The variable must be a data object with a determinable storage address. The variable can be of any data type, including intrinsic and derived data types. The variable cannot be a procedure name, subroutine name, module name, function name, literal constant, label, zero-sized string, zero-length array, or array with a vector subscript.

*prefetch\_depth*

is a variable to be prefetched. The variable must be a data object with a determinable storage address. The variable can be of any data type, including intrinsic and derived data types. The variable cannot be a procedure name, subroutine name, module name, function name, literal constant, label, zero-sized string, zero-length array, or array with a vector subscript.

*prefetch\_depth* can be specified by either an integer variable or a numeric literal ranging from 0 to 7. It is a relative value with the levels defined

qualitatively as follows:

Table 35. Prefetch depth

Integer value	Depth
0	default
1	none
2	shallowest
3	shallow
4	medium
5	deep
6	deeper
7	deepest

*stream\_ID*

is the ID for the prefetched stream. It must be scalar and of type integer. For POWER5 it can be any number from 0 to 7 and for POWER6 any number from 0 to 15.

*unit\_count*

is the number of cache lines for the limited-length protected stream. It must be scalar and of type integer. It can be any number from 0 to 1023. For a stream that is larger than 1024 cache lines, use the **PROTECTED\_UNLIMITED\_STREAM** directives instead of the **PROTECTED\_STREAM** directives.

## Related information

For information on applying prefetch techniques to loops with a large iteration count, see the **STREAM\_UNROLL** directive.



---

## Chapter 14. Intrinsic procedures

Fortran defines a number of procedures, called intrinsic procedures, that are available to any program. This section provides an alphabetical reference to these procedures.

### Related information:

1. “Intrinsic procedures” on page 179 provides background information that you may need to be familiar with before proceeding with this section.
2. “INTRINSIC” on page 392 is a related statement.

---

## Classes of intrinsic procedures

There are five classes of intrinsic procedures: inquiry functions, elemental procedures, system inquiry functions, transformational functions, and subroutines.

### Inquiry intrinsic functions

The result of an *inquiry function* depends on the properties of its principal argument, not on the value of the argument. The value of the argument does not have to be defined.

- ALLOCATED
- ASSOCIATED
- BIT\_SIZE
- COMMAND\_ARGUMENT\_COUNT **2**
- DIGITS
- EPSILON
- EXTENDS\_TYPE\_OF **2**
- HUGE
- KIND
- LBOUND
- LEN
- LOC **1**
- MAXEXPONENT
- MINEXPONENT
- NEW\_LINE **2**
- NUM\_PARTHDS **1**
- NUM\_USRTHDS **1**
- PRECISION
- PRESENT
- RADIX
- RANGE
- SAME\_TYPE\_AS **2**
- SHAPE
- SIZE
- SIZEOF **1**
- TINY
- UBOUND

### Notes:

1. IBM Extension.
2. Fortran 2003 Standard.

### Elemental intrinsic procedures

Some intrinsic functions and one intrinsic subroutine (**MVBITS**) are *elemental*. That is, they can be specified for scalar arguments, but also accept arguments that are arrays.

If all arguments are scalar, the result is a scalar.

If any argument is an array, all **INTENT(OUT)** and **INTENT(INOUT)** arguments must be arrays of the same shape, and the remaining arguments must be conformable with them.

The shape of the result is the shape of the argument with the greatest rank. The elements of the result are the same as if the function was applied individually to the corresponding elements of each argument.

ABS	EXPONENT	MERGE
ACHAR	FLOOR	MIN
ACOS	FRACTION	MOD
ACOSD <b>1</b>	GAMMA <b>1</b>	MODULO
ADJUSTL	HFIX <b>1</b>	MVBITS
ADJUSTR	IACHAR	NEAREST
AIMAG	IAND	NINT
AINT	IBCLR	NOT
ANINT	IBITS	POPCNT <b>2</b>
ASIN	IBSET	POPCNTB <b>2</b>
ASIND <b>1</b>	ICHAR	POPPAR <b>2</b>
ATAN	IEOR	QCMLPX <b>1</b>
ATAND <b>1</b>	ILEN <b>1</b>	QEXT <b>1</b>
ATAN2	INDEX	REAL
ATAN2D <b>1</b>	INT	RRSPACING
BTEST	INT2 <b>1</b>	RSHIFT
CEILING	IOR	SCALE
CHAR	ISHFT	SCAN
CMLPX	ISHFTC	SET_EXPONENT
CONJG	IS_IOSTAT_END <b>2</b>	SIGN
COS	IS_IOSTAT_EOR <b>2</b>	SIN
COSD <b>1</b>	LEADZ <b>1</b>	SIND <b>1</b>
COSH	LEN_TRIM	SINH
CVMGx <b>1</b>	LGAMMA <b>1</b>	SPACING
DBLE	LGE	SQRT
DCMLPX <b>1</b>	LGT	TAN
DIM	LLE	TAND <b>1</b>
DPROD	LLT	TANH
ERF <b>1</b>	LOG	VERIFY
ERFC <b>1</b>	LOG10	
EXP	LOGICAL	
	LSHIFT <b>1</b>	
	MAX	

**Notes:**

1. IBM Extension.
2. Fortran 2003 Standard.

## System inquiry intrinsic functions

IBM Extension

The *system inquiry functions* may be used in restricted expressions. They cannot be used in initialization expressions, nor can they be passed as actual arguments.

- NUMBER\_OF\_PROCESSORS
- PROCESSORS\_SHAPE

End of IBM Extension

## Transformational intrinsic functions

All other intrinsic functions are classified as *transformational functions*. They generally accept array arguments and return array results that depend on the values of elements in the argument arrays.

- ALL
- ANY
- COUNT
- CSHIFT
- DOT\_PRODUCT
- EOSHIFT
- MATMUL
- MAXLOC
- MAXVAL
- MINLOC
- MINVAL
- NULL **1**
- PACK
- PRODUCT
- REPEAT
- RESHAPE
- SELECTED\_CHAR\_KIND
- SELECTED\_INT\_KIND
- SELECTED\_REAL\_KIND
- SPREAD
- SUM
- TRANSFER
- TRANSPOSE
- TRIM
- UNPACK

### Notes:

1. Fortran 95.

For background information on arrays, see Chapter 5, “Array concepts,” on page 71.

## Intrinsic subroutines

Some intrinsic procedures are subroutines. They perform a variety of tasks.

- ALIGNX **1**
- ABORT **1**
- CPU\_TIME **2**
- DATE\_AND\_TIME
- GETENV **1**
- GET\_COMMAND **3**
- GET\_COMMAND\_ARGUMENT **3**
- GET\_ENVIRONMENT\_VARIABLE **3**
- MOVE\_ALLOC **3**
- MVBITS
- RANDOM\_NUMBER
- RANDOM\_SEED
- SIGNAL **1**
- SRAND **1**
- SYSTEM **1**
- SYSTEM\_CLOCK

### Notes:

1. IBM Extension.
2. Fortran 95.
3. Fortran 2003 Standard.

---

## Data representation models

### Integer bit model

The following model shows how the processor represents each bit of a nonnegative scalar integer object:

$$j = \sum_{k=0}^{s-1} w_k \times 2^k$$

$j$  is the integer value

$s$  is the number of bits

$w_k$  is binary digit  $w$  located at position  $k$

IBM Extension

XL Fortran implements the following  $s$  parameters for the XL Fortran integer kind type parameters:

Integer Kind Parameter	$s$ Parameter
1	8
2	16
4	32
8	64

End of IBM Extension

The following intrinsic functions use this model:

BTEST	IBSET	ISHFTC
IAND	IEOR	MVBITS
IBCLR	IOR	NOT
IBITS	ISHFT	

## Integer data model

$$i = s \times \sum_{k=1}^q w_k \times r^{k-1}$$

$i$  is the integer value

$s$  is the sign ( $\pm 1$ )

$q$  is the number of digits (positive integer)

$w_k$  is a nonnegative digit  $< r$

$r$  is the radix

IBM Extension

XL Fortran implements this model with the following  $r$  and  $q$  parameters:

Integer Kind Parameter	$r$ Parameter	$q$ Parameter
1	2	7



Integer Kind Parameter	<i>r</i> Parameter	<i>q</i> Parameter
2	2	15
4	2	31
8	2	63

End of IBM Extension

The following intrinsic functions use this model:

DIGITS                      RADIX                      RANGE  
HUGE

## Real data model

$$x = \begin{cases} 0 & \text{or} \\ s \times b^e \times \sum_{k=1}^p f_k \times b^{-k} \end{cases}$$

- x*      is the real value
- s*      is the sign ( $\pm 1$ )
- b*      is an integer  $> 1$
- e*      is an integer, where  $e_{\min} \leq e \leq e_{\max}$
- p*      is an integer  $> 1$
- f<sub>k</sub>*    is a nonnegative integer  $< b$  ( $f_1 \neq 0$ )

**Note:** If  $x=0$ , then  $e=0$  and all  $f_k=0$ .

IBM Extension

XL Fortran implements this model with the following parameters:

Real Kind parameter	<i>b</i> Parameter	<i>p</i> Parameter	<i>e<sub>min</sub></i> Parameter	<i>e<sub>max</sub></i> Parameter
4	2	24	-125	128
8	2	53	-1021	1024
16	2	106	-1021	1024

End of IBM Extension

The following intrinsic functions use this model:

DIGITS	MINEXPONENT	RRSPACING
EPSILON	NEAREST	SCALE
EXPONENT	PRECISION	SET_EXPONENT
FRACTION	RADIX	SPACING
HUGE	RANGE	TINY
MAXEXPONENT		

---

## Detailed descriptions of intrinsic procedures

The following is an alphabetical list of all generic names for intrinsic procedures.

For each procedure, several items of information are listed.

### Notes:

1. The argument names listed in the title can be used as the names for keyword arguments when calling the procedure.
2. For those procedures with specific names, a table lists each specific name along with information about the specific function:
  - When a function return type or argument type is shown in lowercase, that indicates that the type is specified as shown, but the compiler may actually substitute a call to a different specific name depending on the settings of the **-qintsize**, **-qrealsize**, and **-qautodbl** options.  
For example, references to **SINH** are replaced by references to **DSINH** when **-qrealsize=8** is in effect, and references to **DSINH** are replaced by references to **QSINH**.
  - The column labeled “Pass as Arg?” indicates whether or not you can pass that specific name as an actual argument to a procedure. Only the specific name of an intrinsic procedure may be passed as an actual argument, and only for some specific names. A specific name passed this way may only be referenced with scalar arguments.
3. The index contains entries for each specific name, if you know the specific name but not the generic one.

---

## ABORT()

IBM Extension

### Purpose

Terminates the program and truncates all open output files to the current position of the file pointer, closes all open files, and sends the **SIGABRT** signal to the current process.

If this signal is neither caught or ignored, the core file is saved in the current directory.

### Class

Subroutine

## Examples

The following is an example of a statement using the **ABORT** subroutine.  
IF (ERROR\_CONDITION) CALL ABORT

End of IBM Extension

---

## ABS(A)

### Purpose

Absolute value.

### Class

Elemental function

### Argument type and attributes

A must be of type integer, real, or complex.

### Result type and attributes

The same as A, except that if A is complex, the result is real.

### Result value

- If A is of type integer or real, the result is  $|A|$ .
- If A is of type complex with value (x,y), the result approximates

$$\sqrt{x^2 + y^2}$$

## Examples

**ABS** ((3.0, 4.0)) has the value 5.0.

Specific Name	Argument Type	Result Type	Pass As Arg?
IABS	any integer <b>2</b>	same as argument	yes
ABS	default real	default real	yes
DABS	double precision real	double precision real	yes
QABS <b>1</b>	REAL(16)	REAL(16)	yes
CABS	default complex	default real	yes
CDABS <b>1</b>	double complex	double precision real	yes
ZABS <b>1</b>	double complex	double precision real	yes
CQABS <b>1</b>	COMPLEX(16)	REAL(16)	yes

### Notes:

1. IBM Extension.
2. IBM Extension: the ability to specify a nondefault integer argument.
3. Given that X is a complex number in the form  $a + bi$ , where  $i = (-1)^{\frac{1}{2}}$ :
  - a.  $\text{abs}(b)$  must be less than or equal to 88.7228; a is any real value.
  - b.  $\text{abs}(b)$  must be less than or equal to 709.7827; a is any real value.

---

## ACHAR(I, KIND)

### Purpose

Returns the character in a specified position of the ASCII collating sequence. It is the inverse of the IACHAR function.

### Class

Elemental function

### Argument type and attributes

**I** must be of type integer.

**KIND (optional)**  
must be a scalar integer initialization expression.

### Result type and attributes

Character of length one. If **KIND** is present, the kind type parameter is that specified by the value of **KIND**; otherwise, the result is of type character.

### Result value

- If **I** has a value in the range  $0 \leq I \leq 127$ , the result is the character in position **I** of the ASCII collating sequence, provided that the character corresponding to **I** is representable.
- If **I** is outside the allowed value range, the result is undefined.

### Examples

ACHAR (88) has the value 'X'.

---

## ACOS(X)

### Purpose

Arccosine (inverse cosine) function.

### Class

Elemental function

### Argument type and attributes

**X** must be of type real with a value that satisfies the inequality  $|X| \leq 1$ .

### Result type and attributes

Same as **X**.

### Result value

- It is expressed in radians, and approximates  $\arccos(X)$ .
- It is in the range  $0 \leq \text{ACOS}(X) \leq \pi$ .

### Examples

ACOS (1.0) has the value 0.0.

Specific Name	Argument Type	Result Type	Pass As Arg?
ACOS	default real	default real	yes
DACOS	double precision real	double precision real	yes
QACOS <b>1</b>	REAL(16)	REAL(16)	yes
QARCOS <b>1</b>	REAL(16)	REAL(16)	yes

**Notes:**

1. IBM Extension.

---

## ACOSD(X)

IBM Extension

### Purpose

Arccosine (inverse cosine) function. Result in degrees.

### Class

Elemental function

### Argument type and attributes

X must be of type real. Its value must satisfy the inequality  $|X| \leq 1$ .

### Result type and attributes

Same as X.

### Result value

- It is expressed in degrees and approximates  $\arccos(X)$ .
- It is in the range  $0^\circ \leq \text{ACOSD}(X) \leq 180^\circ$ .

### Examples

ACOSD (0.5) has the value 60.0.

Specific Name	Argument Type	Result Type	Pass As Arg?
ACOSD	default real	default real	yes
DACOSD	double precision real	double precision real	yes
QACOSD	REAL(16)	REAL(16)	yes

End of IBM Extension

---

## ADJUSTL(String)

### Purpose

Adjust to the left, removing leading blanks and inserting trailing blanks.

### Class

Elemental function

## Argument type and attributes

STRING must be of type character.

## Result type and attributes

Character of the same length and kind type parameter as STRING.

## Result value

The value of the result is the same as STRING except that any leading blanks have been deleted and the same number of trailing blanks have been inserted.

## Examples

ADJUSTL ('bWORD') has the value 'WORDb'.

---

## ADJUSTR(STRING)

### Purpose

Adjust to the right, removing trailing blanks and inserting leading blanks.

### Class

Elemental function

## Argument type and attributes

STRING must be of type character.

## Result type and attributes

Character of the same length and kind type parameter as STRING.

## Result value

The value of the result is the same as STRING except that any trailing blanks have been deleted and the same number of leading blanks have been inserted.

## Examples

ADJUSTR ('WORDb') has the value 'bWORD'.

---

## AIMAG(Z), IMAG(Z)

### Purpose

Imaginary part of a complex number.

### Class

Elemental function

## Argument type and attributes

Z must be of type complex.

## Result type and attributes

Real with the same kind type parameter as Z.

## Result value

If  $Z$  has the value  $(x,y)$ , the result has the value  $y$ .

## Examples

AIMAG ((2.0, 3.0)) has the value 3.0.

Specific Name	Argument Type	Result Type	Pass As Arg?
AIMAG	default complex	default real	yes
DIMAG <b>1</b>	double complex	double precision real	yes
QIMAG <b>1</b>	COMPLEX(16)	REAL(16)	yes

### Notes:

1. IBM Extension.

---

## AINT(A, KIND)

### Purpose

Truncates to a whole number.

### Class

Elemental function

### Argument type and attributes

$A$  must be of type real.

$KIND$  (optional)  
must be a scalar integer initialization expression.

### Result type and attributes

- The result type is real.
- If  $KIND$  is present, the kind type parameter is that specified by  $KIND$ ; otherwise, the kind type parameter is that of  $A$ .

### Result value

- If  $|A| < 1$ , the result is zero.
- If  $|A| \geq 1$ , the result has a value equal to the integer whose magnitude is the largest integer that does not exceed the magnitude of  $A$  and whose sign is the same as the sign of  $A$ .

### Examples

AINT(3.555) = 3.0  
AINT(-3.555) = -3.0

Specific Name	Argument Type	Result Type	Pass As Arg?
AINT	default real	default real	yes
DINT	double precision real	double precision real	yes
QINT <b>1</b>	REAL(16)	REAL(16)	yes

**Notes:**

1. IBM Extension.

---

## ALIGNX(K,M)

---

IBM Extension

---

### Purpose

The **ALIGNX** built-in subroutine enables you to assert the alignment of a variable at a certain point in the program flow. Specifically, at the call point to **ALIGNX**, you can assert that the remainder from dividing the address of the second argument by the value of the first argument is zero. In case the second argument is a Fortran 90 pointer, the assertion refers to the address of the target. In case the second argument is an integer pointer, the assertion refers to the address of the pointee. Should you give the compiler incorrect alignment, the resulting program may not run correctly if alignment-sensitive instructions are either executed (such as **VMX** operations) or inserted by the optimizer.

### Class

Subroutine

### Argument type and attributes

- K** is an **INTEGER(4)** positive constant expression whose value is a power of two.
- M** is a variable of any type. When **M** is a Fortran 90 pointer, the pointer must be associated.

### Examples

```
INTEGER*4 B(200)
DO N=1, 200
  CALL ALIGNX(4, B(N))  !ASSERTS THAT AT THIS POINT,
  B(N) = N              !B(N) IS 4-BYTE ALIGNED
END DO
END
```

```
SUBROUTINE VEC(A, B, C)
  INTEGER A(200), B(200), C(200)
  CALL ALIGNX(16, A(1))
  CALL ALIGNX(16, B(1))
  CALL ALIGNX(16, C(1))
  DO N = 1, 200
    C(N) = A(N) + B(N)
  END DO
END SUBROUTINE
```

---

End of IBM Extension

---

---

## ALL(MASK, DIM)

### Purpose

Determines if all values in an entire array, or in each vector along a single dimension, are true.



## Class

Transformational function

## Argument type and attributes

**MASK**

is a logical array.

**DIM (optional)**

is an integer scalar in the range  $1 \leq \mathbf{DIM} \leq \text{rank}(\mathbf{MASK})$ . The corresponding actual argument must not be an optional dummy argument.

## Result value

The result is a logical array with the same type parameters as **MASK**. The rank of the result is  $\text{rank}(\mathbf{MASK})-1$  if the **DIM** is specified; otherwise the result is a scalar of type logical.

The shape of the result is  $(s_1, s_2, \dots, s_{(\mathbf{DIM}-1)}, s_{(\mathbf{DIM}+1)}, \dots, s_n)$ , where  $n$  is the rank of **MASK**.

Each element in the result array is **.TRUE.** only if all the elements given by **MASK**( $m_1, m_2, \dots, m_{(\mathbf{DIM}-1)}, m_{(\mathbf{DIM}+1)}, \dots, m_n$ ), are true. When the result is a scalar, either because **DIM** is not specified or because **MASK** is of rank one, it is **.TRUE.** only if all elements of **MASK** are true, or **MASK** has size zero.

## Examples

```
! A is the array | 4 3 6 |, and B is the array | 3 5 2 |
!               | 2 4 1 |                     | 7 8 4 |
```

```
! Is every element in A less than the
! corresponding one in B?
RES = ALL(A .LT. B)           ! result RES is false
```

```
! Are all elements in each column of A less than the
! corresponding column of B?
RES = ALL(A .LT. B, DIM = 1) ! result RES is (f,t,f)
```

```
! Same question, but for each row of A and B.
RES = ALL(A .LT. B, DIM = 2) ! result RES is (f,t)
```

---

## ALLOCATED(X)

### Purpose

Indicates whether or not an allocatable object is currently allocated.

### Class

Inquiry function

### Argument type and attributes

*X* can be one of the following:

**ARRAY** is an allocatable array whose allocation status you want to know.

**SCALAR** is an allocatable scalar whose allocation status you want to know.

## Result type and attributes

Default logical scalar.

## Result value

The result corresponds to the allocation status of ARRAY or SCALAR: `.TRUE.` if it is currently allocated, `.FALSE.` if it is not currently allocated, or undefined if its allocation status is undefined. If you are compiling with the `-qxlf90=autodealloc` compiler option there is no undefined allocation status.

## Examples

```
INTEGER, ALLOCATABLE, DIMENSION(:) :: A
PRINT *, ALLOCATED(A)      ! A is not allocated yet.
ALLOCATE (A(1000))
PRINT *, ALLOCATED(A)      ! A is now allocated.
END
```

## Related information

“Allocatable arrays” on page 77, “ALLOCATE” on page 275, “Allocation status” on page 26.

---

## ANINT(A, KIND)

### Purpose

Nearest whole number.

### Class

Elemental function

### Argument type and attributes

**A** must be of type real.

**KIND (optional)**  
must be a scalar integer initialization expression.

### Result type and attributes

- The result type is real.
- If **KIND** is present, the kind type parameter is that specified by **KIND**; otherwise, the kind type parameter is that of **A**.

### Result value

- If  $A > 0$ ,  $\text{ANINT}(A) = \text{AINT}(A + 0.5)$
- If  $A \leq 0$ ,  $\text{ANINT}(A) = \text{AINT}(A - 0.5)$

**Note:** The addition and subtraction of 0.5 are done in round-to-zero mode.

### Examples

```
ANINT(3.555) = 4.0
ANINT(-3.555) = -4.0
```

Specific Name	Argument Type	Result Type	Pass As Arg?
ANINT	default real	default real	yes
DNINT	double precision real	double precision real	yes
QNINT <b>1</b>	REAL(16)	REAL(16)	yes

**Notes:**

1. IBM Extension.

## ANY(MASK, DIM)

### Purpose

Determines if any of the values in an entire array, or in each vector along a single dimension, are true.

### Class

Transformational function

### Argument type and attributes

**MASK** is a logical array.

**DIM (optional)**

is an integer scalar in the range  $1 \leq \mathbf{DIM} \leq \text{rank}(\mathbf{MASK})$ . The corresponding actual argument must not be an optional dummy argument.

### Result value

The result is a logical array of the same type parameters as **MASK**. The rank of the result is  $\text{rank}(\mathbf{MASK})-1$  if the **DIM** is specified; otherwise the result is a scalar of type logical.

The shape of the result is  $(s_1, s_2, \dots, s_{(\mathbf{DIM}-1)}, s_{(\mathbf{DIM}+1)}, \dots, s_n)$ , where  $n$  is the rank of **MASK**.

Each element in the result array is **.TRUE.** if any of the elements given by  $\mathbf{MASK}(m_1, m_2, \dots, m_{(\mathbf{DIM}-1)}, :, m_{(\mathbf{DIM}+1)}, \dots, m_n)$  are true. When the result is a scalar, either because **DIM** is not specified or because **MASK** is of rank one, it is **.TRUE.** if any of the elements of **MASK** are true.

### Examples

```
! A is the array | 9 -6 7 |, and B is the array | 2 7 8 |
!               | 3 -1 5 |                     | 5 6 9 |
```

```
! Is any element in A greater than or equal to the
! corresponding element in B?
RES = ANY(A .GE. B)           ! result RES is true
```

```
! For each column in A, is there any element in the column
! greater than or equal to the corresponding element in B?
RES = ANY(A .GE. B, DIM = 1) ! result RES is (t,f,f)
```

```
! Same question, but for each row of A and B.
RES = ANY(A .GE. B, DIM = 2) ! result RES is (t,f)
```

---

## ASIN(X)

### Purpose

Arcsine (inverse sine) function.

### Class

Elemental function

### Argument type and attributes

$X$  must be of type real. Its value must satisfy the inequality  $|X| \leq 1$ .

### Result type and attributes

Same as  $X$ .

### Result value

- It is expressed in radians, and approximates  $\arcsin(X)$ .
- It is in the range  $-\pi/2 \leq \text{ASIN}(X) \leq \pi/2$ .

### Examples

$\text{ASIN}(1.0)$  approximates  $\pi/2$ .

Specific Name	Argument Type	Result Type	Pass As Arg?
ASIN	default real	default real	yes
DASIN	double precision real	double precision real	yes
QASIN <b>1</b>	REAL(16)	REAL(16)	yes
QARSIN <b>1</b>	REAL(16)	REAL(16)	yes

#### Notes:

1. IBM Extension.

---

## ASIND(X)

IBM Extension

### Purpose

Arcsine (inverse sine) function. Result in degrees.

### Class

Elemental function

### Argument type and attributes

$X$  must be of type real. Its value must satisfy the inequality  $|X| \leq 1$ .

### Result type and attributes

Same as  $X$ .

## Result value

- It is expressed in degrees, and approximates arcsin(X).
- It is in the range  $-90^\circ \leq \text{ASIND}(X) \leq 90^\circ$

## Examples

ASIND (0.5) has the value 30.0.

Specific Name	Argument Type	Result Type	Pass As Arg?
ASIND	default real	default real	yes
DASIND	double precision real	double precision real	yes
QASIND	REAL(16)	REAL(16)	yes

End of IBM Extension

---

## ASSOCIATED(POINTER, TARGET)

### Purpose

Returns the association status of its pointer argument, or indicates whether the pointer is associated with the target.

### Class

Inquiry function

### Argument type and attributes

**POINTER** A pointer whose association status you want to test. It can be of any type. Its association status must not be undefined.

**TARGET (optional)**

A pointer or target that might or might not be associated with **POINTER**. The association status must not be undefined.

### Result type and attributes

Default logical scalar.

### Result value

If only the **POINTER** argument is specified, the result is **.TRUE.** if it is associated with any target and **.FALSE.** otherwise. If **TARGET** is also specified, the procedure tests whether **POINTER** is associated with **TARGET**, or with the same object that **TARGET** is associated with (if **TARGET** is also pointer).

If a **POINTER** and a **TARGET** of a different shape are associated, this intrinsic will return **.FALSE.**

If **TARGET** is present, then the result is **.FALSE.** if one of the following occurs:

- **POINTER** is associated with a zero-sized array.
- **TARGET** is associated with a zero-sized array.
- **TARGET** is a zero-sized array.

Objects with different types or shapes cannot be associated with each other.

Arrays with the same type and shape but different bounds can be associated with each other.

## Examples

```

REAL, POINTER, DIMENSION(:,:) :: A
REAL, TARGET, DIMENSION(5,10) :: B, C

NULLIFY (A)
PRINT *, ASSOCIATED (A)    ! False, not associated yet

A => B
PRINT *, ASSOCIATED (A)    ! True, because A is
                           ! associated with B

PRINT *, ASSOCIATED (A,C) ! False, A is not
                           ! associated with C

END

```

---

## ATAN(X)

### Purpose

Arctangent (inverse tangent) function.

### Class

Elemental function

### Argument type and attributes

X must be of type real.

### Result type and attributes

Same as X.

### Result value

- It is expressed in radians and approximates  $\arctan(X)$ .
- It is in the range  $-\pi/2 \leq \text{ATAN}(X) \leq \pi/2$ .

## Examples

ATAN (1.0) approximates  $\pi/4$ .

Specific Name	Argument Type	Result Type	Pass As Arg?
ATAN	default real	default real	yes
DATAN	double precision real	double precision real	yes
QATAN <b>1</b>	REAL(16)	REAL(16)	yes

### Notes:

1. IBM Extension.

---

## ATAND(X)

IBM Extension

### Purpose

Arctangent (inverse tangent) function. Result in degrees.

### Class

Elemental function

### Argument type and attributes

X must be of type real.

### Result type and attributes

Same as X.

### Result value

- It is expressed in degrees and approximates  $\arctan(X)$ .
- It is in the range  $-90^\circ \leq \text{ATAND}(X) \leq 90^\circ$ .

### Examples

ATAND (1.0) has the value 45.0.

Specific Name	Argument Type	Result Type	Pass As Arg?
ATAND	default real	default real	yes
DATAND	double precision real	double precision real	yes
QATAND	REAL(16)	REAL(16)	yes

End of IBM Extension

---

## ATAN2(Y, X)

### Purpose

Arctangent (inverse tangent) function. The result is the principal value of the nonzero complex number (X, Y) formed by the real arguments Y and X.

### Class

Elemental function

### Argument type and attributes

Y must be of type real.

X must be of the same type and kind type parameter as Y. If Y has the value zero, X must not have the value zero.

### Result type and attributes

Same as X.

## Result value

- It is expressed in radians and has a value equal to the principal value of the argument of the complex number (X, Y).
- It is in the range  $-\pi < \text{ATAN2}(Y, X) \leq \pi$ .
- If  $X \neq 0$ , the result approximates  $\arctan(Y/X)$ .
- If  $Y > 0$ , the result is positive.
- If  $Y < 0$ , the result is negative.
- If  $X = 0$ , the absolute value of the result is  $\pi/2$ .

The `-qxlf2003=signdzerointr` option controls whether you get Fortran 2003 behavior. See `qxlf2003` in the *XL Fortran Compiler Reference*

Fortran 95

End of Fortran 95

- If  $Y = 0$  and  $X < 0$ , the result is  $\pi$ .

Fortran 2003

End of Fortran 2003

- If  $Y = 0$  and  $X < 0$ , the result is  $\pi$  if Y is positive real zero and  $-\pi$  if Y is negative real zero.

## Examples

`ATAN2` (1.5574077, 1.0) has the value 1.0.

Given that:

$$Y = \begin{vmatrix} 1 & 1 \\ -1 & -1 \end{vmatrix} \quad X = \begin{vmatrix} -1 & 1 \\ -1 & 1 \end{vmatrix}$$

the value of `ATAN2`(Y,X) is approximately:

$$\text{ATAN2}(Y, X) = \begin{vmatrix} 3\pi/4 & \pi/4 \\ -3\pi/4 & -\pi/4 \end{vmatrix}$$

Specific Name	Argument Type	Result Type	Pass As Arg?
<code>ATAN2</code>	default real	default real	yes
<code>DATAN2</code>	double precision real	double precision real	yes
<code>QATAN2</code> <b>1</b>	REAL(16)	REAL(16)	yes

**Notes:**

1. IBM Extension.

---

## ATAN2D(Y, X)

IBM Extension

### Purpose

Arctangent (inverse tangent) function. The result is the principal value of the nonzero complex number (X, Y) formed by the real arguments Y and X.



## Class

Elemental function

## Argument type and attributes

- Y must be of type real.
- X must be of the same type and kind type parameter as Y. If Y has the value zero, X must not have the value zero.

## Result type and attributes

Same as X.

## Result value

- It is expressed in degrees and has a value equal to the principal value of the argument of the complex number (X, Y).
- It is in the range  $-180^\circ < \text{ATAN2D}(Y,X) \leq 180^\circ$ .
- If  $X \neq 0$ , the result approximates  $\arctan(Y/X)$ .
- If  $Y > 0$ , the result is positive.
- If  $Y < 0$ , the result is negative.
- If  $Y = 0$  and  $X > 0$ , the result is zero.
- If  $Y = 0$  and  $X < 0$ , the result is  $180^\circ$ .
- If  $X = 0$ , the absolute value of the result is  $90^\circ$ .

## Examples

`ATAN2D` (1.5574077, 1.0) has the value 57.295780181 (approximately).

Given that:

$$Y = \begin{vmatrix} 1.0 & 1.0 \\ -1.0 & -1.0 \end{vmatrix} \quad X = \begin{vmatrix} -1.0 & 1.0 \\ -1.0 & 1.0 \end{vmatrix}$$

then the value of `ATAN2D(Y,X)` is:

$$\text{ATAN2D}(Y,X) = \begin{vmatrix} 135.0000000 & 45.0000000 \\ -135.0000000 & -45.0000000 \end{vmatrix}$$

Specific Name	Argument Type	Result Type	Pass As Arg?
<code>ATAN2D</code>	default real	default real	yes
<code>DATAN2D</code>	double precision real	double precision real	yes
<code>QATAN2D</code>	REAL(16)	REAL(16)	yes

End of IBM Extension

---

## BIT\_SIZE(I)

### Purpose

Returns the number of bits in an integer type. Because only the type of the argument is examined, the argument need not be defined.

### Class

Inquiry function

## Argument type and attributes

I must be of type integer.

## Result type and attributes

Scalar integer with the same kind type parameter as I.

## Result value

The result is the number of bits in the integer data type of the argument:

IBM Extension	
type	bits
integer(1)	8
integer(2)	16
integer(4)	32
integer(8)	64

End of IBM Extension

The bits are numbered from 0 to BIT\_SIZE(I)-1, from right to left.

## Examples

BIT\_SIZE (1\_4) has the value 32, because the integer type with kind 4 (that is, a four-byte integer) contains 32 bits.

---

## BTEST(I, POS)

### Purpose

Tests a bit of an integer value.

### Class

Elemental function

## Argument type and attributes

I must be of type integer.

POS must be of type integer. It must be nonnegative and be less than BIT\_SIZE(I).

## Result type and attributes

The result is of type default logical.

## Result value

The result has the value .TRUE. if bit POS of I has the value 1 and the value .FALSE. if bit POS of I has the value 0.

The bits are numbered from 0 to BIT\_SIZE(I)-1, from right to left.

## Examples

BTEST (8, 3) has the value .TRUE..

```

If A has the value
  | 1 2 |
  | 3 4 |
the value of BTEST (A, 2) is
  | false false |
  | false true  |
and the value of BTEST (2, A) is
  | true  false |
  | false false |

```

See “Integer bit model” on page 531.

Specific Name	Argument Type	Result Type	Pass As Arg?
BTEST <b>1</b>	any integer	default logical	yes

**Notes:**

1. IBM Extension.

## CEILING(A, KIND)

### Purpose

Returns the least integer greater than or equal to its argument.

### Class

Elemental function

### Argument type and attributes

**A** must be of type real.

Fortran 95

**KIND (optional)**

must be a scalar integer initialization expression.

End of Fortran 95

### Result type and attributes

- It is of type integer.

Fortran 95

- If **KIND** is present, the kind type parameter is that specified by **KIND**; otherwise, the **KIND** type parameter is that of the default integer type.

End of Fortran 95

### Result value

The result has a value equal to the least integer greater than or equal to **A**.

Fortran 95

The result is undefined if the result cannot be represented as an integer of the

specified KIND.

End of Fortran 95

## Examples

CEILING(-3.7) has the value -3.  
CEILING(3.7) has the value 4.

Fortran 95

CEILING(1000.1, KIND=2) has the value 1001, with a kind type parameter of two.

End of Fortran 95

## CHAR(I, KIND)

### Purpose

Returns the character in the given position of the collating sequence associated with the specified kind type parameter. It is the inverse of the function **ICHAR**.

### Class

Elemental function

### Argument type and attributes

**I** must be of type integer with a value in the range  $0 \leq I \leq 127$ .

IBM

**KIND (optional)**

must be a scalar integer initialization expression.

### Result type and attributes

- Character of length one.
- If **KIND** is present, the kind type parameter is that specified by **KIND**; otherwise, the kind type parameter is that of the default character type.

### Result value

- The result is the character in position **I** of the collating sequence associated with the specified kind type parameter.
- **ICHAR (CHAR (I, KIND (C)))** must have the value **I** for  $0 \leq I \leq 127$  and **CHAR (ICHAR (C), KIND (C))** must have the value **C** for any representable character.

## Examples

IBM Extension

**CHAR** (88) has the value 'X'.

Specific Name	Argument Type	Result Type	Pass As Arg?
CHAR	any integer	default character	yes <b>1</b>

**Notes:**

1. IBM Extension: the ability to specify a nondefault integer argument.
2. XL Fortran supports only the ASCII collating sequence.

End of IBM Extension

---

## CMPLX(X, Y, KIND)

### Purpose

Convert to complex type.

### Class

Elemental function

### Argument type and attributes

- X** must be of type integer, real, or complex, or a binary, octal, or hexadecimal constant.
- Y (optional)** must be of type integer, or real, or a binary, octal, or hexadecimal constant. It must not be present if X is of type complex.
- KIND (optional)** must be a scalar integer initialization expression.

### Result type and attributes

- It is of type complex.
- If **KIND** is present, the kind type parameter is that specified by **KIND**; otherwise, the kind type parameter is that of the default real type.

### Result value

- If Y is absent and X is not complex, it is as if Y were present with the value zero.
- If Y is absent and X is complex, it is as if Y were present with the value AIMAG(X).
- CMPLX(X, Y, KIND) has the complex value whose real part is REAL(X, KIND) and whose imaginary part is REAL(Y, KIND).

### Examples

CMPLX (-3) has the value (-3.0, 0.0).

Specific Name	Argument Type	Result Type	Pass As Arg?
CMPLX <b>1</b>	default real	default complex	no

**Notes:**

1. IBM Extension.

### Related information

“DCMPLX(X, Y) ” on page 564, “QCMPLX(X, Y) ” on page 633.

---

## COMMAND\_ARGUMENT\_COUNT()

Fortran 2003

### Purpose

Returns the number of command line arguments for the command that invoked the program.

### Class

Inquiry function

### Result type and attributes

Default integer scalar

### Result value

The result value is the number of command arguments, not counting the command name. If there are no command arguments, the result value is 0.

### Examples

```
integer cmd_count
cmd_count = COMMAND_ARGUMENT_COUNT()
print*, cmd_count
end
```

The following is sample output generated by the above program:

```
$ a.out
0
$ a.out aa
1
$ a.out aa bb
2
```

End of Fortran 2003

---

## CONJG(Z)

### Purpose

Conjugate of a complex number.

### Class

Elemental function

### Argument type and attributes

**Z** must be of type complex.

### Result type and attributes

Same as **Z**.

## Result value

Given Z has the value (x, y), the result has the value (x, -y).

## Examples

CONJG ((2.0, 3.0)) has the value (2.0, -3.0).

Specific Name	Argument Type	Result Type	Pass As Arg?
CONJG	default complex	default complex	yes
DCONJG <b>1</b>	double complex	double complex	yes
QCONJG <b>1</b>	COMPLEX(16)	COMPLEX(16)	yes

### Notes:

1. IBM Extension.

---

## COS(X)

### Purpose

Cosine function.

### Class

Elemental function

### Argument type and attributes

X must be of type real or complex.

### Result type and attributes

Same as X.

### Result value

- It has a value that approximates  $\cos(X)$ .
- If X is of type real, X is regarded as a value in radians.
- If X is of type complex, the real and imaginary parts of X are regarded as values in radians.

## Examples

COS (1.0) has the value 0.54030231 (approximately).

Specific Name	Argument Type	Result Type	Pass As Arg?
COS	default real	default real	yes
DCOS	double precision real	double precision real	yes
QCOS <b>1</b>	REAL(16)	REAL(16)	yes
CCOS <b>2a</b>	default complex	default complex	yes
CDCOS <b>1 2b</b>	double complex	double complex	yes
ZCOS <b>1 2b</b>	double complex	double complex	yes
CQCOS <b>1 2b</b>	COMPLEX(16)	COMPLEX(16)	yes

**Notes:**

1. IBM Extension.
2. Given that  $X$  is a complex number in the form  $a + bi$ , where  $i = (-1)^{\frac{1}{2}}$  :
  - a.  $\text{abs}(b)$  must be less than or equal to 88.7228;  $a$  is any real value.
  - b.  $\text{abs}(b)$  must be less than or equal to 709.7827;  $a$  is any real value.

---

## COSD(X)

IBM Extension

### Purpose

Cosine function. Argument in degrees.

### Class

Elemental function

### Argument type and attributes

$X$  must be of type real.

### Result type and attributes

Same as  $X$ .

### Result value

- It approximates  $\cos(X)$ , where  $X$  has a value in degrees.

### Examples

COSD (45.0) has the value 0.7071067691.

Specific Name	Argument Type	Result Type	Pass As Arg?
COSD	default real	default real	yes
DCOSD	double precision real	double precision real	yes
QCOSD	REAL(16)	REAL(16)	yes

End of IBM Extension

---

## COSH(X)

### Purpose

Hyperbolic cosine function.

### Class

Elemental function

### Argument type and attributes

$X$  must be of type real.



## Result type and attributes

Same as X.

## Result value

The result value approximates  $\cosh(X)$ .

## Examples

**COSH** (1.0) has the value 1.5430806 (approximately).

Specific Name	Argument Type	Result Type	Pass As Arg?
COSH	default real	default real	yes
DCOSH	double precision real	double precision real	yes
QCOSH <b>2</b>	REAL(16)	REAL(16)	yes

### Notes:

1. IBM Extension

---

## COUNT(MASK, DIM, KIND)

### Purpose

Counts the number of true array elements in an entire logical array, or in each vector along a single dimension. Typically, the logical array is one that is used as a mask in another intrinsic.

### Class

Transformational function

### Argument type and attributes

**MASK** is a logical array.

**DIM (optional)** is an integer scalar in the range  $1 \leq \mathbf{DIM} \leq \text{rank}(\mathbf{MASK})$ . The corresponding actual argument must not be an optional dummy argument.

**KIND (optional)** must be a scalar integer initialization expression.

### Result value

If **DIM** is present, the result is an integer array of rank  $\text{rank}(\mathbf{MASK})-1$ . If **DIM** is missing, or if **MASK** has a rank of one, the result is a scalar of type integer.

If **KIND** is present, the kind of the result is that specified by the value of **KIND**; otherwise, the kind of the result is **KIND(0)**.

Each element of the resulting array ( $R(s_1, s_2, \dots, s_{(\mathbf{DIM}-1)}, s_{(\mathbf{DIM}+1)}, \dots, s_n)$ ) equals the number of elements that are true in **MASK** along the corresponding dimension ( $s_1, s_2, \dots, s_{(\mathbf{DIM}-1)}, \dots, s_{(\mathbf{DIM}+1)}, \dots, s_n$ ).

If **MASK** is a zero-sized array, the result equals zero.

## Examples

```
! A is the array | T F F |, and B is the array | F F T |
!               | F T T |                   | T T T |

! How many corresponding elements in A and B
! are equivalent?
  RES = COUNT(A .EQV. B)      ! result RES is 3

! How many corresponding elements are equivalent
! in each column?
  RES = COUNT(A .EQV. B, DIM=1) ! result RES is (0,2,1)

! Same question, but for each row.
  RES = COUNT(A .EQV. B, DIM=2) ! result RES is (1,2)
```

---

## CPU\_TIME(TIME)

Fortran 95

### Purpose

Returns the CPU time, in seconds, taken by the current process and, possibly, all the child processes in all of the threads. A call to **CPU\_TIME** will give the processor time taken by the process from the start of the program. The time measured only accounts for the amount of time that the program is actually running, and not the time that a program is suspended or waiting.

### Class

Subroutine

### Argument type and attributes

<b>TIME</b>	Is a scalar of type real. It is an <b>INTENT(OUT)</b> argument that is assigned an approximation to the processor time. The time is measured in seconds. The time returned by <b>CPU_TIME</b> is dependent upon the setting of the <b>XLFRTEOPTS</b> environment variable run-time option <b>cpu_time_type</b> . The valid settings for <b>cpu_time_type</b> are:
<b>usertime</b>	The user time for the current process. For a definition of user time, see the <i>AIX Performance and Tuning Guide</i> .
<b>systemtime</b>	The system time for the current process. For a definition of system time, see the <i>AIX Performance and Tuning Guide</i> .
<b>alltime</b>	The sum of the user and system time for the current process
<b>total_usertime</b>	The total user time for the current process. The total user time is the sum of the user time for the current process and the total user times for its child processes, if any.
<b>total_systemtime</b>	The total system time for the current process. The total system time is the sum of the system time for the current process and the total system times for its child processes, if any.

**total\_alltime** The total user and system time for the current process. The total user and system time is the sum of the user and system time for the current process and the total user and system times for their child processes, if any.

This is the default measure of time for **CPU\_TIME** if you have not set the **cpu\_time\_type** run-time option.

You can set the **cpu\_time\_type** run-time option using the **setrteopts** procedure. Each change to the **cpu\_time\_type** setting will affect all subsequent calls to **CPU\_TIME**.

## Examples

### Example 1:

```
! The default value for cpu_time_type is used
REAL T1, T2
...      ! First chunk of code to be timed
CALL CPU_TIME(T1)
...      ! Second chunk of code to be timed
CALL CPU_TIME(T2)
print *, 'Time taken for first chunk of code: ', T1, 'seconds.'
print *, 'Time taken for both chunks of code: ', T2, 'seconds.'
print *, 'Time for second chunk of code was ', T2-T1, 'seconds.'
```

If you want to set the **cpu\_time\_type** run-time option to **usertime**, you would type the following command from a ksh or bsh command line:

```
export XLF RTEOPTS=cpu_time_type=usertime
```

### Example 2:

```
! Use setrteopts to set the cpu_time_type run-time option as many times
! as you need to
CALL setrteopts ('cpu_time_type=alltime')
CALL stallingloop
CALL CPU_TIME(T1)
print *, 'The sum of the user and system time is', T1, 'seconds'.
CALL setrteopts ('cpu_time_type=usertime')
CALL stallingloop
CALL CPU_TIME(T2)
print *, 'The total user time from the start of the program is', T2, 'seconds'.
```

## Related information

- See the description of the **XLF RTEOPTS** environment variable in the *XL Fortran Compiler Reference* for more information.

End of Fortran 95

---

## CSHIFT(ARRAY, SHIFT, DIM)

### Purpose

Shifts the elements of all vectors along a given dimension of an array. The shift is circular; that is, elements shifted off one end are inserted again at the other end.

### Class

Transformational function

## Argument type and attributes

- ARRAY** is an array of any type.
- SHIFT** must be a scalar integer if **ARRAY** has a rank of one; otherwise, it is a scalar integer or an integer expression of rank  $\text{rank}(\text{ARRAY})-1$ .
- DIM (optional)** is an integer scalar in the range  $1 \leq \text{DIM} \leq \text{rank}(\text{ARRAY})$ . If absent, it defaults to 1.

## Result value

The result is an array with the same shape and the same data type as **ARRAY**.

If **SHIFT** is a scalar, the same shift is applied to each vector. Otherwise, each vector **ARRAY** ( $s_1, s_2, \dots, s_{(\text{DIM}-1)}, s_{(\text{DIM}+1)}, \dots, s_n$ ) is shifted according to the corresponding value in **SHIFT** ( $s_1, s_2, \dots, s_{(\text{DIM}-1)}, s_{(\text{DIM}+1)}, \dots, s_n$ )

The absolute value of **SHIFT** determines the amount of shift. The sign of **SHIFT** determines the direction of the shift:

### Positive SHIFT

moves each element of the vector toward the beginning of the vector.

### Negative SHIFT

moves each element of the vector toward the end of the vector.

**Zero SHIFT** does no shifting. The value of the vector remains unchanged.

## Examples

```
! A is the array | A D G |
!               | B E H |
!               | C F I |

! Shift the first column down one, the second column
! up one, and leave the third column unchanged.
RES = CSHIFT (A, SHIFT = (/ -1, 1, 0 /), DIM = 1)
! The result is | C E G |
!               | A F H |
!               | B D I |

! Do the same shifts as before, but on the rows
! instead of the columns.
RES = CSHIFT (A, SHIFT = (/ -1, 1, 0 /), DIM = 2)
! The result is | G A D |
!               | E H B |
!               | C F I |
```

---

## CVMGx(TSOURCE, FSOURCE, MASK)

IBM Extension

### Purpose

The conditional vector merge functions (**CVMGM**, **CVMGN**, **CVMGP**, **CVMGT**, and **CVMGZ**) enable you to port existing code that contains these functions.

Calling them is very similar to calling

```

MERGE ( TSOURCE, FSOURCE, arith_expr .op. 0 )
or
MERGE ( TSOURCE, FSOURCE, logical_expr .op. .TRUE. )

```

Because the **MERGE** intrinsic is part of the Fortran 90 language, we recommend that you use it instead of these functions for any new programs.

## Class

Elemental function

## Argument type and attributes

**TSOURCE** is a scalar or array expression of type **LOGICAL**, **INTEGER**, or **REAL** and any kind except 1.

**FSOURCE** is a scalar or array expression with the same type and type parameters as **TSOURCE**.

**MASK** is a scalar or array expression of type **INTEGER** or **REAL** (for **CVMGM**, **CVMGN**, **CVMGP**, and **CVMGZ**) or **LOGICAL** (for **CVMGT**), and any kind except 1. If it is an array, it must conform in shape to **TSOURCE** and **FSOURCE**.

If only one of **TSOURCE** and **FSOURCE** is typeless, the typeless argument acquires the type of the other argument. If both **TSOURCE** and **FSOURCE** are typeless, both arguments acquire the type of **MASK**. If **MASK** is also typeless, both **TSOURCE** and **FSOURCE** are treated as default integers. If **MASK** is typeless, it is treated as a default logical for the **CVMGT** function and as a default integer for the other **CVMGx** functions.

## Result type and attributes

Same as **TSOURCE** and **FSOURCE**.

## Result value

The function result is the value of either the first argument or second argument, depending on the result of the test performed on the third argument. If the arguments are arrays, the test is performed for each element of the **MASK** array, and the result may contain some elements from **TSOURCE** and some elements from **FSOURCE**.

Table 36. Result values for **CVMGx** intrinsic procedures

Explanation	Function Return Value	Generic Name
Test for positive or zero	<b>TSOURCE</b> if <b>MASK</b> ≥0 <b>FSOURCE</b> if <b>MASK</b> <0	<b>CVMGP</b>
Test for negative	<b>TSOURCE</b> if <b>MASK</b> <0 <b>FSOURCE</b> if <b>MASK</b> ≥0	<b>CVMGM</b>
Test for zero	<b>TSOURCE</b> if <b>MASK</b> =0 <b>FSOURCE</b> if <b>MASK</b> ≠0	<b>CVMGZ</b>
Test for nonzero	<b>TSOURCE</b> if <b>MASK</b> ≠0 <b>FSOURCE</b> if <b>MASK</b> =0	<b>CVMGN</b>
Test for true	<b>TSOURCE</b> if <b>MASK</b> = .true. <b>FSOURCE</b> if <b>MASK</b> = .false.	<b>CVMGT</b>

End of IBM Extension

---

## DATE\_AND\_TIME(DATE, TIME, ZONE, VALUES)

### Purpose

Returns data from the real-time clock and the date in a form compatible with the representations defined in ISO 8601:1988.

### Class

Subroutine

### Argument type and attributes

#### DATE (optional)

must be scalar and of type default character, and must have a length of at least eight to contain the complete value. It is an **INTENT(OUT)** argument. Its leftmost eight characters are set to a value of the form **CCYYMMDD**, where **CC** is the century, **YY** is the year within the century, **MM** is the month within the year, and **DD** is the day within the month. If no date is available, these characters are set to blank.

#### TIME (optional)

must be scalar and of type default character, and must have a length of at least ten in order to contain the complete value. It is an **INTENT(OUT)** argument. Its leftmost ten characters are set to a value of the form **hhmmss.sss**, where **hh** is the hour of the day, **mm** is the minutes of the hour, and **ss.sss** is the seconds and milliseconds of the minute. If no clock is available, they are set to blank.

#### ZONE (optional)

must be scalar and of type default character, and must have a length at least five in order to contain the complete value. It is an **INTENT(OUT)** argument. Its leftmost five characters are set to a value of the form **±hhmm**, where **hh** and **mm** are the time difference with respect to Coordinated Universal Time (UTC) in hours and the parts of an hour expressed in minutes, respectively. If no clock is available, they are set to blank.

---

#### IBM Extension

The value of **ZONE** may be incorrect if you have not set up the machine through the **smit chtz** fastpath, or if you are in a timezone not configurable through **smit**. You can manually set the **TZ** environment variable or use the **chtz** command to ensure the time zone is correctly set up. The format of the **TZ** variable is documented under the **/etc/environment** file in the *AIX Files Reference*.

---

#### End of IBM Extension

#### VALUES (optional)

must be of type default integer and of rank one. It is an **INTENT(OUT)** argument. Its size must be at least eight. The values returned in **VALUES** are as follows:

**VALUES(1)**

is the year (for example, 1998), or -HUGE (0) if no date is available.

**VALUES(2)**

is the month of the year, or -HUGE (0) if no date is available.

**VALUES(3)**

is the day of the month, or -HUGE (0) if no date is available.

**VALUES(4)**

is the time difference with respect to Coordinated Universal Time (UTC) in minutes, or -HUGE (0) if this information is not available.

**VALUES(5)**

is the hour of the day, in the range 0 to 23, or -HUGE (0) if there is no clock.

**VALUES(6)**

is the minutes of the hour, in the range 0 to 59, or -HUGE (0) if there is no clock.

**VALUES(7)**

is the seconds of the minute, in the range 0 to 60, or -HUGE (0) if there is no clock.

**VALUES (8)**

is the milliseconds of the second, in the range 0 to 999, or -HUGE (0) if there is no clock.

## Examples

The following program:

```
INTEGER DATE_TIME (8)
CHARACTER (LEN = 10) BIG_BEN (3)
CALL DATE_AND_TIME (BIG_BEN (1), BIG_BEN (2), &
                   BIG_BEN (3), DATE_TIME)
```

if executed in Geneva, Switzerland on 1985 April 12 at 15:27:35.5, would have assigned the value 19850412 to **BIG\_BEN(1)**, the value 152735.500 to **BIG\_BEN(2)**, the value +0100 to **BIG\_BEN(3)**, and the following values to **DATE\_TIME**: 1985, 4, 12, 60, 15, 27, 35, 500.

Note that UTC is defined by CCIR Recommendation 460-2 (also known as Greenwich Mean Time).

---

## DBLE(A)

### Purpose

Convert to double precision real type.

### Class

Elemental function

## Argument type and attributes

A must be of type integer, real, or complex, or a boz-literal constant.

## Result type and attributes

Double precision real.

## Result value

- If A is of type double precision real,  $DBLE(A) = A$ .
- If A is of type integer or real, the result has as much precision of the significant part of A as a double precision real datum can contain.
- If A is of type complex, the result has as much precision of the significant part of the real part of A as a double precision real datum can contain.

## Examples

`DBLE (-3)` has the value `-3.0D0`.

IBM Extension			
Specific Name	Argument Type	Result Type	Pass As Arg?
DFLOAT	any integer	double precision real	no
DBLE	default real	double precision real	no
DBLEQ	REAL(16)	REAL(8)	no

End of IBM Extension

---

## DCMPLX(X, Y)

IBM Extension			
---------------	--	--	--

## Purpose

Convert to double complex type.

## Class

Elemental function

## Argument type and attributes

X must be of type integer, real, or complex.

Y (optional) must be of type integer or real. It must not be present if X is of type complex.

## Result type and attributes

It is of type double complex.

## Result value

- If Y is absent and X is not complex, it is as if Y were present with the value of zero.
- If Y is absent and X is complex, it is as if Y were present with the value  $AIMAG(X)$ .



- DCMPLEX(X, Y) has the complex value whose real part is REAL(X, KIND=8) and whose imaginary part is REAL(Y, KIND=8).

## Examples

DCMPLEX (-3) has the value (-3.0D0, 0.0D0).

Specific Name	Argument Type	Result Type	Pass As Arg?
DCMPLEX	double precision real	double complex	no

## Related information

“CMPLX(X, Y, KIND) ” on page 553, “QCMPLX(X, Y) ” on page 633.

End of IBM Extension

## DIGITS(X)

### Purpose

Returns the number of significant digits for numbers whose type and kind type parameter are the same as the argument.

### Class

Inquiry function

### Argument type and attributes

X must be of type integer or real. It may be scalar or array valued.

### Result type and attributes

Default integer scalar.

### Result value

#### IBM Extension

- If X is of type integer, the number of the significant digits of X is:

type	bits
integer(1)	7
integer(2)	15
integer(4)	31
integer(8)	63

- If X is of type real, the number of significant bits of X is:

type	bits
real(4)	24
real(8)	53
real(16)	106

End of IBM Extension

## Examples

IBM Extension

**DIGITS** (X) = 63, where X is of type integer(8) (see “Data representation models” on page 531).

End of IBM Extension

---

## DIM(X, Y)

### Purpose

The difference X-Y if it is positive; otherwise zero.

### Class

Elemental function

### Argument type and attributes

X must be of type integer or real.

Y must be of the same type and kind type parameter as X.

### Result type and attributes

Same as X.

### Result value

- If  $X > Y$ , the value of the result is  $X - Y$ .
- If  $X \leq Y$ , the value of the result is zero.

## Examples

**DIM** (-3.0, 2.0) has the value 0.0. **DIM** (-3.0, -4.0) has the value 1.0.

Specific Name	Argument Type	Result Type	Pass As Arg?
IDIM	any integer <b>1</b>	same as argument	yes
DIM	default real	default real	yes
DDIM	double precision real	double precision real	yes
QDIM <b>2</b>	REAL(16)	REAL(16)	yes

#### Notes:

1. IBM Extension: the ability to specify a nondefault integer argument.
2. IBM Extension.

---

## DOT\_PRODUCT(VECTOR\_A, VECTOR\_B)

### Purpose

Computes the dot product on two vectors.

### Class

Transformational function

## Argument type and attributes

**VECTOR\_A** is a vector with a numeric or logical data type.

**VECTOR\_B** must be of numeric type if **VECTOR\_A** is of numeric type and of logical type if **VECTOR\_A** is of logical type. It must be the same size as **VECTOR\_A**.

## Result value

The result is a scalar whose data type depends on the data type of the two vectors, according to the rules in Table 15 on page 100 and Table 16 on page 104.

If either vector is a zero-sized array, the result equals zero when it has a numeric data type, and false when it is of type logical.

If **VECTOR\_A** is of type integer or real, the result value equals  $\text{SUM}(\text{VECTOR\_A} * \text{VECTOR\_B})$ .

If **VECTOR\_A** is of type complex, the result equals  $\text{SUM}(\text{CONJG}(\text{VECTOR\_A}) * \text{VECTOR\_B})$ .

If **VECTOR\_A** is of type logical, the result equals  $\text{ANY}(\text{VECTOR\_A} .\text{AND.} \text{VECTOR\_B})$ .

## Examples

```
! A is (/ 3, 1, -5 /), and B is (/ 6, 2, 7 /).
      RES = DOT_PRODUCT (A, B)
! calculated as
!   ( (3*6) + (1*2) + (-5*7) )
! = (  18  +   2  + (-35) )
! = -15
```

---

## DPROD(X, Y)

### Purpose

Double precision real product.

### Class

Elemental function

## Argument type and attributes

**X** must be of type default real.

**Y** must be of type default real.

## Result type and attributes

Double precision real.

## Result value

The result has a value equal to the product of X and Y.

## Examples

**DPROD** (-3.0, 2.0) has the value -6.0D0.

Specific Name	Argument Type	Result Type	Pass As Arg?
DPROD	default real	double precision real	yes
QPROD <b>1</b>	double precision real	REAL(16)	yes

**Notes:**

1. IBM Extension.

## EOSHIFT(ARRAY, SHIFT, BOUNDARY, DIM)

### Purpose

Shifts the elements of all vectors along a given dimension of an array. The shift is end-off; that is, elements shifted off one end are lost, and copies of boundary elements are shifted in at the other end.

### Class

Transformational function

### Argument type and attributes

<b>ARRAY</b>	is an array of any type.
<b>SHIFT</b>	is a scalar of type integer if <b>ARRAY</b> has a rank of 1; otherwise, it is a scalar integer or an integer expression of rank $\text{rank}(\text{ARRAY})-1$ .
<b>BOUNDARY (optional)</b>	is of the same type and type parameters as <b>ARRAY</b> . If <b>ARRAY</b> has a rank of 1, <b>BOUNDARY</b> must be scalar. Otherwise, <b>BOUNDARY</b> is a scalar or an expression of rank $=\text{rank}(\text{ARRAY})-1$ , and of shape (d1, d2..., dDIM-1, dDIM+1..., dn).
<b>DIM (optional)</b>	is an integer scalar in the range $1 \leq \text{DIM} \leq \text{rank}(\text{ARRAY})$ .

### Result value

The result is an array with the same shape and data type as **ARRAY**.

The absolute value of **SHIFT** determines the amount of shift. The sign of **SHIFT** determines the direction of the shift:

<b>Positive SHIFT</b>	moves each element of the vector toward the beginning of the vector. If an element is taken off the beginning of a vector, its value is replaced by the corresponding value from <b>BOUNDARY</b> at the end of the vector.
<b>Negative SHIFT</b>	moves each element of the vector toward the end of the vector. If an element is taken off the end of a vector, its value is replaced by the corresponding value from <b>boundary</b> at the beginning of the vector.
<b>Zero SHIFT</b>	does no shifting. The value of the vector remains unchanged.

## Result value

If **BOUNDARY** is a scalar value, this value is used in all shifts.

If **BOUNDARY** is an array of values, the values of the array elements of **BOUNDARY** with subscripts ( $s_1, s_2, \dots, s_{(DIM-1)}, s_{(DIM+1)}, \dots, s_n$ ) are used for that dimension.

If **BOUNDARY** is not specified, the following default values are used, depending on the data type of **ARRAY**:

<b>character</b>	'b' (one blank)
<b>logical</b>	false
<b>integer</b>	0
<b>real</b>	0.0
<b>complex</b>	(0.0, 0.0)

## Examples

```
! A is | 1.1 4.4 7.7 |, SHIFT is
S=(/0, -1, 1/),
!      | 2.2 5.5 8.8 |
!      | 3.3 6.6 9.9 |
! and BOUNDARY is the array B=(/-0.1, -0.2, -0.3/).

! Leave the first column alone, shift the second
! column down one, and shift the third column up one.
RES = EOSHIFT (A, SHIFT = S, BOUNDARY = B, DIM = 1)
! The result is | 1.1 -0.2 8.8 |
!              | 2.2 4.4 9.9 |
!              | 3.3 5.5 -0.3 |

! Do the same shifts as before, but on the
! rows instead of the columns.
RES = EOSHIFT (A, SHIFT = S, BOUNDARY = B, DIM = 2)
! The result is | 1.1 4.4 7.7 |
!              | -0.2 2.2 5.5 |
!              | 6.6 9.9 -0.3 |
```

---

## EPSILON(X)

### Purpose

Returns a positive model number that is almost negligible compared to unity in the model representing numbers of the same type and kind type parameter as the argument.

### Class

Inquiry function

### Argument type and attributes

X must be of type real. It may be scalar or array valued.

### Result type and attributes

Scalar of the same type and kind type parameter as X.

## Result value

The result is  
 $2.0ei0^{1 - \text{DIGITS}(X)}$

where  $ei$  is the exponent indicator (E, D, or Q) depending on the type of X:

IBM Extension	
type	EPSILON(X)
----	-----
real(4)	02E0 ** (-23)
real(8)	02D0 ** (-52)
real(16)	02Q0 ** (-105)

End of IBM Extension

## Examples

IBM Extension	
EPSILON (X) = 1.1920929E-07 for X of type real(4). See "Real data model" on page 533.	

End of IBM Extension

---

## ERF(X)

IBM Extension	
---------------	--

### Purpose

Error function.

$$\text{erf}(x) = \frac{2}{\sqrt{\pi}} \int_0^x e^{-t^2} dt$$

### Class

Elemental function

### Argument type and attributes

X must be of type real.

### Result type and attributes

Same as X.

### Result value

- The result value approximates erf(X).
- The result is in the range  $-1 \leq \text{ERF}(X) \leq 1$

## Examples

ERF (1.0) has the value 0.8427007794 (approximately).

Specific Name	Argument Type	Result Type	Pass As Arg?
ERF	default real	default real	yes
DERF	double precision real	double precision real	yes
QERF	REAL(16)	REAL(16)	yes

End of IBM Extension

## ERFC(X)

IBM Extension

### Purpose

Complementary error function.

$$\operatorname{erfc}(x) = 1 - \operatorname{erf}(x) = \frac{2}{\sqrt{\pi}} \int_x^{\infty} e^{-t^2} dt$$

### Class

Elemental function

### Argument type and attributes

X must be of type real.

### Result type and attributes

Same as X.

### Result value

- The result has a value equal to 1-ERF(X).
- The result is in the range  $0 \leq \operatorname{ERFC}(X) \leq 2$

## Examples

ERFC (1.0) has the value 0.1572992057 (approximately).

Specific Name	Argument Type	Result Type	Pass As Arg?
ERFC	default real	default real	yes
DERFC	double precision real	double precision real	yes
QERFC	REAL(16)	REAL(16)	yes

End of IBM Extension

---

## EXP(X)

### Purpose

Exponential.

### Class

Elemental function

### Argument type and attributes

X must be of type real or complex.

### Result type and attributes

Same as X.

### Result value

- The result approximates  $e^x$ .
- If X is of type complex, its real and imaginary parts are regarded as values in radians.

### Examples

EXP (1.0) has the value 2.7182818 (approximately).

Specific Name	Argument Type	Result Type	Pass As Arg?
EXP <b>1</b>	default real	default real	yes
DEXP <b>2</b>	double precision real	double precision real	yes
QEXP <b>2</b> <b>3</b>	REAL(16)	REAL(16)	yes
CEXP <b>4a</b>	default complex	default complex	yes
CDEXP <b>4b</b> <b>3</b>	double complex	double complex	yes
ZEXP <b>4b</b> <b>3</b>	double complex	double complex	yes
CQEXP <b>4b</b> <b>3</b>	COMPLEX(16)	COMPLEX(16)	yes

#### Notes:

1. X must be less than or equal to 88.7228.
2. X must be less than or equal to 709.7827.
3. IBM Extension.
4. When X is a complex number in the form  $a + bi$ , where  $i = (-1)^{\frac{1}{2}}$ :
  - a. a must be less than or equal to 88.7228; b is any real value.
  - b. a must be less than or equal to 709.7827; b is any real value.

---

## EXPONENT(X)

### Purpose

Returns the exponent part of the argument when represented as a model number.

### Class

Elemental function



## Argument type and attributes

**X** must be of type real.

## Result type and attributes

Default integer.

## Result value

- If  $X \neq 0$ , the result is the exponent of  $X$  (which is always within the range of a default integer).
- If  $X = 0$ , the exponent of  $X$  is zero.

## Examples

`EXPONENT (10.2) = 4`. See “Real data model” on page 533

---

## EXTENDS\_TYPE\_OF(A, MOLD)

Fortran 2003

### Purpose

Inquires whether the dynamic type of **A** is an extension type of the dynamic type of **MOLD**.

### Class

Inquiry function

### Argument type and attributes

**A** Must be an object of extensible type. If **A** is a pointer, **A** must not have an undefined association status.

**MOLD**

Must be an object of extensible type. If **MOLD** is a pointer, **MOLD** must not have an undefined association status.

### Result type and attributes

Default logical scalar

### Result value

- If **MOLD** is unlimited polymorphic and is a disassociated pointer or unallocated allocatable, the result is true.
- Otherwise, if **A** is unlimited polymorphic and is either a disassociated pointer or unallocated allocatable, the result is false.
- Otherwise, if the dynamic type of **A** is an extension type of the dynamic type of **MOLD**, the result is true.
- Otherwise, the result is false.

End of Fortran 2003

---

## FLOOR(A, KIND)

### Purpose

Returns the greatest integer less than or equal to its argument.

### Class

Elemental function

### Argument type and attributes

**A** must be of type real.

Fortran 95

**KIND (optional)**

must be a scalar integer initialization expression.

End of Fortran 95

### Result type and attributes

- It is of type integer.

Fortran 95

- If **KIND** is present, the kind type parameter is that specified by **KIND**; otherwise, the **KIND** type parameter is that of the default integer type.

End of Fortran 95

### Result value

The result has a value equal to the greatest integer less than or equal to **A**.

Fortran 95

The result is undefined if the result cannot be represented as an integer of the specified **KIND**.

End of Fortran 95

### Examples

FLOOR(-3.7) has the value -4.  
FLOOR(3.7) has the value 3.

Fortran 95

FLOOR(1000.1, KIND=2) has the value 1000, with a kind type parameter of two.

End of Fortran 95

---

## FRACTION(X)

### Purpose

Returns the fractional part of the model representation of the argument value.

### Class

Elemental function

### Argument type and attributes

X must be of type real.

### Result type and attributes

Same as X.

### Result value

IBM Extension

The result is:

$$X * (2.0^{-\text{EXPONENT}(X)})$$

End of IBM Extension

### Examples

IBM Extension

FRACTION(10.2) =  $2^{-4} * 10.2$  approximately equal to 0.6375

End of IBM Extension

---

## GAMMA(X)

IBM Extension

### Purpose

Gamma function.

$$\Gamma(x) = \int_0^{\infty} u^{x-1} e^{-u} du$$

### Class

Elemental function

### Argument type and attributes

X must be of type real.

## Result type and attributes

Same as X.

## Result value

The result has a value that approximates  $\Gamma(X)$ .

## Examples

GAMMA (1.0) has the value 1.0.

GAMMA (10.0) has the value 362880.0 (approximately).

Specific Name	Argument Type	Result Type	Pass As Arg?
GAMMA <b>1</b>	default real	default real	yes
DGAMMA <b>2</b>	double precision real	double precision real	yes
QGAMMA <b>3</b>	REAL(16)	REAL(16)	yes

**X must satisfy the inequality:**

1.  $-2.0^{**}23 < X \leq 35.0401$ , except for nonpositive integral values
2.  $-2.0^{**}52 < X \leq 171.6243$ , except for nonpositive integral values
3.  $-2.0^{**}105 < X \leq 171.6243$ , except for nonpositive integral values

End of IBM Extension

---

## GETENV(NAME, VALUE)

IBM Extension

### Purpose

Returns the value of the specified environment variable.

**Note:** This is an IBM extension. It is recommended that you use the GET\_ENVIRONMENT\_VARIABLE intrinsic procedure for portability.

### Class

Subroutine

### Argument type and attributes

NAME	is a character string that identifies the name of the operating-system environment variable. The string is case-significant. It is an <b>INTENT(IN)</b> argument that must be scalar of type default character.
VALUE	holds the value of the environment variable when the subroutine returns. It is an <b>INTENT(OUT)</b> argument that must be scalar of type default character.

### Result value

The result is returned in the VALUE argument, not as a function result variable.

If the environment variable specified in the NAME argument does not exist, the VALUE argument contains blanks.

## Examples

```
CHARACTER (LEN=16)  ENVDATA
CALL GETENV('HOME', VALUE=ENVDATA)
! Print the value.
PRINT *, ENVDATA
! Show how it is blank-padded on the right.
WRITE(*, '(Z32)') ENVDATA
END
```

The following is sample output generated by the above program:

```
/home/mark
```

```
2F686F6D652F6D61726B202020202020
```

## Related information

See the `getenv` subroutine in the *AIX Technical Reference: Base Operating System and Extensions Volume 1* for details about the operating-system-level implementation.

End of IBM Extension

---

## GET\_COMMAND(COMMAND, LENGTH, STATUS)

Fortran 2003

### Purpose

Returns the command that invoked the program.

### Class

Subroutine

### Argument type and attributes

#### COMMAND (optional)

is the command that invoked the program, or a string of blanks if the command is unknown. **COMMAND** is an **INTENT(OUT)** argument that must be scalar of type default character.

#### LENGTH (optional)

is the significant length of the command that invoked the program, or 0 if the length of the command is unknown. This length includes significant trailing blanks of each argument. It does not include any truncation or padding that occurs when the command is assigned to the **COMMAND** argument. It is an **INTENT(OUT)** argument that must be scalar of type default integer.

#### STATUS (optional)

is a status value. It is an **INTENT(OUT)** argument that must be scalar of type default integer.

**STATUS** has one of the following values:

- 1 if the command retrieval fails
- -1 if the **COMMAND** argument is present and has a value less than the significant length of the command

- 0 otherwise

## Examples

```
integer len, status
character(7) :: cmd
call GET_COMMAND(cmd, len, status)
print*, cmd
print*, len
print*, status
end
```

The following is sample output the above program generates:

```
$ a.out
a.out      (followed by two spaces)
5
0
$ a.out aa
a.out a
8
-1
```

End of Fortran 2003

---

## GET\_COMMAND\_ARGUMENT(NUMBER, VALUE, LENGTH, STATUS)

Fortran 2003

### Purpose

Returns a command line argument of the command that invoked the program.

### Class

Subroutine

### Argument type and attributes

**NUMBER** is an integer that identifies the argument number. 0 represents the command name. The numbers from 1 to the argument count represent the command's arguments. It is an **INTENT(IN)** argument that must be scalar of type default integer.

**VALUE (optional)** is assigned the value of the argument, or a string of blanks if the value is unknown. It is an **INTENT(OUT)** argument that must be scalar of type default character.

**LENGTH (optional)** is assigned the significant length of the argument, or 0 if the length of the argument is unknown. This length includes significant trailing blanks. It does not include any truncation or padding that occurs when the argument is assigned to the **VALUE** argument. It is an **INTENT(OUT)** argument that must be scalar of type default integer.

**STATUS (optional)** is assigned a status value. It is an **INTENT(OUT)** argument that must be scalar of type default integer.

It has one of the following values:

- 1 if the argument retrieval fails
- -1 if the VALUE argument is present and has a value less than the significant length of the command argument
- 0 otherwise

## Examples

```
integer num, len, status
character*7 value
num = 0
call GET_COMMAND_ARGUMENT(num, value, len, status)
print*, value
print*, len
print*, status
```

The following is sample output generated by the above program:

```
$ a.out aa bb
a.out      (followed by two spaces)
5
0
```

End of Fortran 2003

---

## GET\_ENVIRONMENT\_VARIABLE(NAME, VALUE, LENGTH, STATUS, TRIM\_NAME)

Fortran 2003

### Purpose

Returns the value of the specified environment variable.

### Class

Subroutine

### Argument type and attributes

**NAME** is a character string that identifies the name of the operating-system environment variable. The string is case-significant. It is an **INTENT(IN)** argument that must be scalar of type default character.

**VALUE (optional)**

is the value of the environment variable, or a string of blanks if the environment variable has no value or does not exist. It is an **INTENT(OUT)** argument that must be scalar of type default character.

**LENGTH (optional)**

is the significant length of the value, or 0 if the environment variable has no value or does not exist. It is an **INTENT(OUT)** argument that must be scalar of type default integer.

**STATUS (optional)**

is a status value. It is an **INTENT(OUT)** argument that must be scalar of type default integer.

**STATUS** has one of the following values:

- 0, if either the environment variable exists and its value is successfully assigned to **VALUE** or the environment variable exists but has no value
- 1, if the environment variable does not exist
- -1, if the **VALUE** argument less than the significant length of value of the environment variable.
- 3, if other error conditions occur

**TRIM\_NAME (optional)**

is a logical value that specifies whether to trim trailing blanks in **NAME**. By default, trailing blanks in **NAME** are trimmed. If **TRIM\_NAME** exists and has the value **.FALSE.**, trailing blanks in **NAME** are considered significant. **TRIM\_NAME** is an **INTENT(IN)** argument that must be scalar of type logical.

## Examples

```
integer num, len, status
character*15 value
call GET_ENVIRONMENT_VARIABLE('HOME', value, len, status)
print*, value
print*, len
print*, status
```

The following is sample output generated by the above program:

```
$ a.out
/home/xlfuser      (followed by two spaces)
13
0
```

End of Fortran 2003

---

## HFIX(A)

IBM Extension

### Purpose

Convert from **REAL(4)** to **INTEGER(2)**.

This procedure is a specific function, not a generic function.

### Class

Elemental function

### Argument type and attributes

**A** must be of type **REAL(4)**.

### Result type and attributes

An **INTEGER(2)** scalar or array.

### Result value

- If  $|A| < 1$ , **HFIX (A)** has the value 0.



- If  $|A| \geq 1$ , HFIX (A) is the integer whose magnitude is the largest integer that does not exceed the magnitude of A and whose sign is the same as the sign of A.
- The result is undefined if the result cannot be represented in an INTEGER(2).

## Examples

HFIX (-3.7) has the value -3.

Specific Name	Argument Type	Result Type	Pass As Arg?
HFIX	REAL(4)	INTEGER(2)	no

End of IBM Extension

## HUGE(X)

### Purpose

Returns the largest number in the model representing numbers of the same type and kind type parameter as the argument.

### Class

Inquiry function

### Argument type and attributes

X must be of type integer or real. It may be a scalar or an array.

### Result type and attributes

Scalar of the same type and kind type parameter as X.

### Result value

- If X is of any integer type, the result is:  
 $2^{\text{DIGITS}(X)} - 1$
- If X is of any real type, the result is:  
 $(1.0 - 2.0^{-\text{DIGITS}(X)}) * (2.0^{\text{MAXEXPONENT}(X)})$

## Examples

IBM Extension
HUGE (X) = (1D0 - 2D0**(-53)) * (2D0**1024) for X of type real(8).
HUGE (X) = (2**63) - 1 for X of type integer(8).
See "Data representation models" on page 531.
End of IBM Extension

---

## IACHAR(C, KIND)

### Purpose

Returns the position of a character in the ASCII collating sequence.

### Class

Elemental function

### Argument type and attributes

**C** must be of type default character and of length one.

**KIND (optional)**  
must be a scalar integer initialization expression.

### Result type and attributes

If **KIND** is present, the result is of type integer with a kind parameter value equal to that specified by **KIND**; otherwise, the result is of type default integer.

### Result value

- If **C** is in the collating sequence defined by the codes specified in ISO 646:1983 (International Reference Version), the result is the position of **C** in that sequence and satisfies the inequality  $(0 \leq \text{IACHAR}(\text{C}) \leq 127)$ . An undefined value is returned if **C** is not in the ASCII collating sequence.
- The results are consistent with the LGE, LGT, LLE, and LLT lexical comparison functions. For example, LLE (**C**, **D**) is true, so IACHAR (**C**) .LE. IACHAR (**D**) is true too.

### Examples

IACHAR ('X') has the value 88.

---

## IAND(I, J)

### Purpose

Performs a bitwise AND on two integers.

### Class

Elemental function

### Argument type and attributes

**I** must be of type integer.

**J** must be of type integer with the same kind type parameter as **I**.

### Result type and attributes

Same as **I**.

### Result value

The result has the value obtained by combining **I** and **J** bit-by-bit according to the following table:

<i>ith</i> bit of I	<i>ith</i> bit of J	<i>ith</i> bit of IAND(I,J)
1	1	1
1	0	0
0	1	0
0	0	0

The bits are numbered from 0 to BIT\_SIZE(I)-1, from right to left.

## Examples

IAND (1, 3) has the value 1. See “Integer bit model” on page 531.

Specific Name	Argument Type	Result Type	Pass As Arg?
IAND <b>1</b>	any integer	same as argument	yes
AND <b>1</b>	any integer	same as argument	yes

### Notes:

1. IBM Extension.

---

## IBCLR(I, POS)

### Purpose

Clears one bit to zero.

### Class

Elemental function

### Argument type and attributes

I must be of type integer.

POS must be of type integer. It must be nonnegative and less than BIT\_SIZE (I).

### Result type and attributes

Same as I.

### Result value

The result has the value of the sequence of bits of I, except that bit POS of I is set to zero.

The bits are numbered from 0 to BIT\_SIZE(I)-1, from right to left.

## Examples

IBCLR (14, 1) has the result 12.

If V has the value (/1, 2, 3, 4/), the value of IBCLR (POS = V, I = 31) is (/29, 27, 23, 15/).

See “Integer bit model” on page 531.

Specific Name	Argument Type	Result Type	Pass As Arg?
IBCLR <b>1</b>	any integer	same as argument	yes

**Notes:**

1. IBM Extension.

## IBITS(I, POS, LEN)

### Purpose

Extracts a sequence of bits.

### Class

Elemental function

### Argument type and attributes

- |     |   |
|-----|---|
| I   | must be of type integer.  |
| POS | must be of type integer. It must be nonnegative and POS + LEN must be less than or equal to BIT_SIZE (I). |
| LEN | must be of type integer and nonnegative.  |

### Result type and attributes

Same as I.

### Result value

The result has the value of the sequence of LEN bits in I beginning at bit POS, right-adjusted and with all other bits zero.

The bits are numbered from 0 to BIT\_SIZE(I)-1, from right to left.

### Examples

IBITS (14, 1, 3) has the value 7. See “Integer bit model” on page 531.

Specific Name	Argument Type	Result Type	Pass As Arg?
IBITS <b>1</b>	any integer	same as argument	yes

**Notes:**

1. IBM Extension.

## IBSET(I, POS)

### Purpose

Sets one bit to one.

### Class

Elemental function

## Argument type and attributes

**I** must be of type integer.

**POS** must be of type integer. It must be nonnegative and less than BIT\_SIZE (I).

## Result type and attributes

Same as I.

## Result value

The result has the value of the sequence of bits of I, except that bit POS of I is set to one.

The bits are numbered from 0 to BIT\_SIZE(I)-1, from right to left.

## Examples

IBSET (12, 1) has the value 14.

If V has the value (/1, 2, 3, 4/), the value of IBSET (POS = V, I = 0) is (/2, 4, 8, 16/).

See “Integer bit model” on page 531.

Specific Name	Argument Type	Result Type	Pass As Arg?
IBSET <b>1</b>	any integer	same as I	yes

### Notes:

1. IBM Extension.

---

## ICHAR(C, KIND)

### Purpose

Returns the position of a character in the collating sequence associated with the kind type parameter of the character.

### Class

Elemental function

### Argument type and attributes

**C** must be of type character and of length one. Its value must be that of a representable character.

**KIND (optional)**

must be a scalar integer initialization expression.

### Result type and attributes

If **KIND** is present, the result is of type integer with a kind parameter value equal to that specified by **KIND**; otherwise, the result is of type default integer.

### Result value

- The result is the position of C in the collating sequence associated with the kind type parameter of C and is in the range  $0 \leq \text{ICHAR}(C) \leq 127$ .

- For any representable characters C and D, C .LE. D is true if and only if ICHAR (C) .LE. ICHAR (D) is true and C .EQ. D is true if and only if ICHAR (C) .EQ. ICHAR (D) is true.

## Examples

### IBM Extension

ICHAR ('X') has the value 88 in the ASCII collating sequence.

Specific Name	Argument Type	Result Type	Pass As Arg?
ICHAR	default character	default integer	yes <b>1</b>

#### Notes:

1. The extension is the ability to pass the name as an argument.
2. XL Fortran supports only the ASCII collating sequence.

### End of IBM Extension

## IEOR(I, J)

### Purpose

Performs an exclusive OR.

### Class

Elemental function

### Argument type and attributes

- I must be of type integer.
- J must be of type integer with the same kind type parameter as I.

### Result type and attributes

Same as I.

### Result value

The result has the value obtained by combining I and J bit-by-bit according to the following truth table:

<i>ith</i> bit of I	<i>ith</i> bit of J	<i>ith</i> bit of IEO(I,J)
1	1	0
1	0	1
0	1	1
0	0	0

The bits are numbered 0 to BIT\_SIZE(I)-1, from right to left.

## Examples

IEOR (1, 3) has the value 2. See "Integer bit model" on page 531.

Specific Name	Argument Type	Result Type	Pass As Arg?
IEOR <b>1</b>	any integer	same as argument	yes
XOR <b>1</b>	any integer	same as argument	yes

**Notes:**

1. IBM Extension.

## ILEN(I)

IBM Extension

### Purpose

Returns one less than the length, in bits, of the twos complement representation of an integer.

### Class

Elemental function

### Argument type and attributes

I is of type integer

### Result type and attributes

Same as I.

### Result value

- If I is negative,  $ILEN(I)=CEILING(LOG2(-I))$
- If I is nonnegative,  $ILEN(I)=CEILING(LOG2(I+1))$

### Examples

```
I=ILEN(4) ! 3
J=ILEN(-4) ! 2
```

End of IBM Extension

## IMAG(Z)

IBM Extension

### Purpose

Identical to AIMAG.

### Related information

“AIMAG(Z), IMAG(Z)” on page 538.

End of IBM Extension

---

## INDEX(String, Substring, Back, Kind)

### Purpose

Returns the starting position of a substring within a string.

### Class

Elemental function

### Argument type and attributes

**STRING** must be of type character.

**SUBSTRING** must be of type character with the same kind type parameter as **STRING**.

**BACK (optional)**  
must be of type logical.

**KIND (optional)**  
must be a scalar integer initialization expression.

### Result type and attributes

If **KIND** is present, the result is of type integer with a kind parameter value equal to that specified by **KIND**; otherwise, the result is of type default integer.

### Result value

- Case (i): If **BACK** is absent or present with the value `.FALSE.`, the result is the minimum positive value of *I* such that `STRING (I : I + LEN (SUBSTRING) - 1) = SUBSTRING` or zero if there is no such value. Zero is returned if `LEN (STRING) < LEN (SUBSTRING)`. One is returned if `LEN (SUBSTRING) = 0`.
- Case (ii): If **BACK** is present with the value `.TRUE.`, the result is the maximum value of *I* less than or equal to `LEN (STRING) - LEN (SUBSTRING) + 1`, such that `STRING (I : I + LEN (SUBSTRING) - 1) = SUBSTRING` or zero if there is no such value. Zero is returned if `LEN (STRING) < LEN (SUBSTRING)` and `LEN (STRING) + 1` is returned if `LEN (SUBSTRING) = 0`.

### Examples

`INDEX ('FORTRAN', 'R')` has the value 3.

`INDEX ('FORTRAN', 'R', BACK = .TRUE.)` has the value 5.

Specific Name	Argument Type	Result Type	Pass As Arg?
INDEX	default character	default integer	yes <b>1</b>

#### Notes:

1. When this specific name is passed as an argument, the procedure can only be referenced without the **BACK** and **KIND** optional argument.

---

## INT(A, Kind)

### Purpose

Convert to integer type.



## Class

Elemental function

## Argument type and attributes

**A** must be of type integer, real, or complex, or a boz-literal constant.

**KIND (optional)**

must be a scalar integer initialization expression.

## Result type and attributes

- Integer.
- If **KIND** is present, the kind type parameter is that specified by **KIND**; otherwise, the kind type parameter is that of the default integer type.

## Result value

- Case (i): If A is of type integer,  $\text{INT}(A) = A$ .
- Case (ii): If A is of type real, there are two cases: if  $|A| < 1$ ,  $\text{INT}(A)$  has the value 0; if  $|A| \geq 1$ ,  $\text{INT}(A)$  is the integer whose magnitude is the largest integer that does not exceed the magnitude of A and whose sign is the same as the sign of A.
- Case (iii): If A is of type complex,  $\text{INT}(A)$  is the value obtained by applying the case (ii) rule to the real part of A.
- Case (iv): If A is a boz-literal constant, it is treated as an integer with a *kind-param* that specifies the representation method with the largest decimal exponent range supported by the processor.
- The result is undefined if it cannot be represented in the specified integer type.

## Examples

$\text{INT}(-3.7)$  has the value -3.

Specific Name	Argument Type	Result Type	Pass As Arg?
INT	default real	default integer	no
IDINT	double precision real	default integer	no
IFIX	default real	default integer	no
IQINT <b>1</b>	REAL(16)	default integer	no

**Notes:**

1. IBM Extension.

## Related information

For information on alternative behavior for **INT** when porting programs to XL Fortran, see the **-qport** compiler option in the *XL Fortran Compiler Reference*.

---

## INT2(A)

IBM Extension

### Purpose

Converts a real or integer value into a two byte integer.

## Class

Elemental function

## Argument type and attributes

$A$  must be a scalar of integer or real type.

INT2 cannot be passed as an actual argument of another function call.

## Result type and attributes

INTEGER(2) scalar

## Result value

If  $A$  is of type integer,  $\text{INT2}(A) = A$ .

If  $A$  is of type real, there are two possibilities:

- If  $|A| < 1$ ,  $\text{INT2}(A)$  has the value 0
- If  $|A| \geq 1$ ,  $\text{INT2}(A)$  is the integer whose magnitude is the largest integer that does not exceed the magnitude of  $A$ , and whose sign is the same as the sign of  $A$ .

In both cases, truncation may occur.

## Examples

The following is an example of the INT2 function.

```
REAL*4 :: R4
REAL*8 :: R8
INTEGER*4 :: I4
INTEGER*8 :: I8

R4 = 8.8; R8 = 18.9
I4 = 4; I8 = 8
PRINT *, INT2(R4), INT2(R8), INT2(I4), INT2(I8)
PRINT *, INT2(2.3), INT2(6)
PRINT *, INT2(65535.78), INT2(65536.89)
END
```

The following is sample output generated by the program above:

```
8 18 4 8
2 6
-1 0      ! The results indicate that truncation has occurred, since
          ! only the last two bytes were saved.
```

End of IBM Extension

---

## IOR(I, J)

### Purpose

Performs an inclusive OR.

### Class

Elemental function

## Argument type and attributes

I must be of type integer.

J must be of type integer with the same kind type parameter as I.

## Result type and attributes

Same as I.

## Result value

The result has the value obtained by combining I and J bit-by-bit according to the following truth table:

<i>i</i> th bit of I	<i>i</i> th bit of J	<i>i</i> th bit of IOR(I,J)
1	1	1
1	0	1
0	1	1
0	0	0

The bits are numbered 0 to BIT\_SIZE(I)-1, from right to left.

## Examples

IOR (1, 3) has the value 3. See “Integer bit model” on page 531.

Specific Name	Argument Type	Result Type	Pass As Arg?
IOR <b>1</b>	any integer	same as argument	yes
OR <b>1</b>	any integer	same as argument	yes

### Notes:

1. IBM Extension.

---

## IS\_IOSTAT\_END(I)

Fortran 2003

### Purpose

Checks for an end-of-file condition.

### Class

Elemental function

### Argument type and attributes

I must be of type integer.

### Result type and attributes

Default logical scalar.

## Result value

Returns `.TRUE.` if the argument indicates an end-of-file condition. Otherwise, `IS_IOSTAT_END` returns `.FALSE.`

End of Fortran 2003

---

## IS\_IOSTAT\_EOR(I)

Fortran 2003

### Purpose

Checks for an end-of-record condition.

### Class

Elemental function

### Argument type and attributes

`I` must be of type integer.

### Result type and attributes

Default logical scalar

### Result value

Returns `.TRUE.` if the argument indicates an end-of-record condition. Otherwise, `IS_IOSTAT_EOR` returns `.FALSE.`

End of Fortran 2003

---

## ISHFT(I, SHIFT)

### Purpose

Performs a logical shift.

### Class

Elemental function

### Argument type and attributes

`I` must be of type integer.

`SHIFT` must be of type integer. The absolute value of `SHIFT` must be less than or equal to `BIT_SIZE (I)`.

### Result type and attributes

Same as `I`.

### Result value

- The result has the value obtained by shifting the bits of `I` by `SHIFT` positions.
- If `SHIFT` is positive, the shift is to the left; if `SHIFT` is negative, the shift is to the right; and, if `SHIFT` is zero, no shift is performed.

- Bits shifted out from the left or from the right, as appropriate, are lost.
- Vacated bits are filled with zeros.
- The bits are numbered 0 to BIT\_SIZE(I)-1, from right to left.

## Examples

ISHFT (3, 1) has the result 6. See “Integer bit model” on page 531.

Specific Name	Argument Type	Result Type	Pass As Arg?
ISHFT <b>1</b>	any integer	same as argument	yes

### Notes:

1. IBM Extension.

## ISHFTC(I, SHIFT, SIZE)

### Purpose

Performs a circular shift of the rightmost bits; that is, bits shifted off one end are inserted again at the other end.

### Class

Elemental function

### Argument type and attributes

- I** must be of type integer.
- SHIFT** must be of type integer. The absolute value of SHIFT must be less than or equal to SIZE.
- SIZE (optional)** must be of type integer. The value of SIZE must be positive and must not exceed BIT\_SIZE (I). If SIZE is absent, it is as if it were present with the value of BIT\_SIZE (I).

### Result type and attributes

Same as I.

### Result value

The result has the value obtained by shifting the SIZE rightmost bits of I circularly by SHIFT positions. If SHIFT is positive, the shift is to the left; if SHIFT is negative, the shift is to the right; and, if SHIFT is zero, no shift is performed. No bits are lost. The unshifted bits are unaltered.

The bits are numbered 0 to BIT\_SIZE(I)-1, from right to left.

## Examples

ISHFTC (3, 2, 3) has the value 5. See “Integer bit model” on page 531.

IBM Extension			
Specific Name	Argument Type	Result Type	Pass As Arg?
ISHFTC	any integer	same as argument	yes <b>1</b>

**Notes:**

1. When this specific name is passed as an argument, the procedure can only be referenced with all three arguments.

End of IBM Extension

---

## KIND(X)

### Purpose

Returns the value of the kind type parameter of X.

### Class

Inquiry function

### Argument type and attributes

X may be of any intrinsic type.

### Result type and attributes

Default integer scalar.

### Result value

The result has a value equal to the kind type parameter value of X.

Kind type parameters supported by XL Fortran are defined in Chapter 3, "Intrinsic Data Types," on page 35.

### Examples

KIND (0.0) has the kind type parameter value of the default real type.

---

## LBOUND(ARRAY, DIM, KIND)

### Purpose

Returns the lower bound of each dimension in an array, or the lower bound of a specified dimension.

### Class

Inquiry function

### Argument type and attributes

**ARRAY** is the array whose lower bounds you want to determine. Its bounds must be defined; that is, it must not be a disassociated pointer or an allocatable array that is not allocated.

**DIM (optional)** is an integer scalar in the range  $1 \leq \mathbf{DIM} \leq \text{rank}(\mathbf{ARRAY})$ . The corresponding actual argument must not be an optional dummy argument.

**KIND (optional)** must be a scalar integer initialization expression.

## Result type and attributes

If **KIND** is present, the result is of type integer with a kind parameter value equal to that specified by **KIND**; otherwise, the result is of type default integer.

If **DIM** is present, the result is a scalar. If **DIM** is not present, the result is a one-dimensional array with one element for each dimension in **ARRAY**.

## Result value

Each element in the result corresponds to a dimension of **array**.

- If **ARRAY** is a whole array or array structure component, **LBOUND(ARRAY, DIM)** is equal to the lower bound for subscript **DIM** of **ARRAY**.

The only exception is for a dimension that is zero-sized and **ARRAY** is not an assumed-size array of rank **DIM**. In such a case, the corresponding element in the result is one regardless of the value declared for the lower bound.

- If **ARRAY** is an array section or expression that is not a whole array or array structure component, each element has the value one.

## Examples

```
REAL A(1:10, -4:5, 4:-5)
RES=LBOUND( A )
! The result is (/ 1, -4, 1 /).

RES=LBOUND( A(:, :, :) )
RES=LBOUND( A(4:10, -4:1, :) )
! The result in both cases is (/ 1, 1, 1 /)
! because the arguments are array sections.
```

---

## LEADZ(I)

IBM Extension

### Purpose

Returns the number of leading zero-bits in the binary representation of an integer.

### Class

Elemental function

### Argument type and attributes

**I** must be of type integer.

### Result type and attributes

Same as **I**.

### Result value

The result is the count of zero-bits to the left of the leftmost one-bit for an integer.

### Examples

```
I = LEADZ(0_4) ! I=32
J = LEADZ(4_4) ! J=29
K = LEADZ(-1_4) ! K=0
```

---

## LEN(String, Kind)

### Purpose

Returns the length of a character entity. The argument to this function need not be defined.

### Class

Inquiry function

### Argument type and attributes

**STRING** must be of type character. It may be scalar or array valued.

**KIND (optional)**  
must be a scalar integer initialization expression.

### Result type and attributes

The result is a scalar integer. If **KIND** is present, the kind of the result is that specified by the value of **KIND**; otherwise, the kind of the result is **KIND(0)**.

### Result value

The result has a value equal to the number of characters in **STRING** if it is scalar or in an element of **STRING** if it is array valued.

### Examples

If **C** is declared by the statement

```
CHARACTER (11) C(100)
```

**LEN (C)** has the value 11.

Specific Name	Argument Type	Result Type	Pass As Arg?
LEN	default character	default integer	yes <b>1</b>

#### Notes:

1. IBM Extension: the ability to pass the name as an argument.

---

## LEN\_TRIM(String, Kind)

### Purpose

Returns the length of the character argument without counting trailing blank characters.

### Class

Elemental function

### Argument type and attributes

**STRING** must be of type character.



**KIND (optional)**

must be a scalar integer initialization expression.

## Result type and attributes

If **KIND** is present, the result is of type integer with a **KIND** parameter value equal to that specified by **KIND**; otherwise, the result is of type default integer.

## Result value

The result has a value equal to the number of characters remaining after any trailing blanks in **STRING** are removed. If the argument contains no nonblank characters, the result is zero.

## Examples

`LEN_TRIM ('bAbBb')` has the value 4. `LEN_TRIM ('bb')` has the value 0.

---

## LGAMMA(X)

IBM Extension

### Purpose

Log of gamma function.

$$\log_e \Gamma(x) = \log_e \int_0^{\infty} u^{x-1} e^{-u} du$$

### Class

Elemental function

### Argument type and attributes

**X** must be of type real.

### Result type and attributes

Same as **X**.

### Result value

The result has a value equal to  $\log_e \Gamma(X)$ .

### Examples

`LGAMMA (1.0)` has the value 0.0.

`LGAMMA (10.0)` has the value 12.80182743 (approximately).

Specific Name	Argument Type	Result Type	Pass As Arg?
LGAMMA	default real	default real	no
LGAMMA	double precision real	double precision real	no
ALGAMA <b>1</b>	default real	default real	yes
DLGAMA <b>2</b>	double precision real	double precision real	yes

Specific Name	Argument Type	Result Type	Pass As Arg?
QLGAMA <b>3</b>	REAL(16)	REAL(16)	yes

**X must satisfy the inequality:**

1.  $0 < X \leq 4.0850E36$ .
2.  $2.3561D-304 \leq X \leq 2^{1014}$ .
3.  $2.3561Q-304 \leq X \leq 2^{1014}$ .

End of IBM Extension

## LGE(String\_A, String\_B)

### Purpose

Test whether a string is lexically greater than or equal to another string, based on the ASCII collating sequence.

### Class

Elemental function

### Argument type and attributes

STRING\_A must be of type default character.

STRING\_B must be of type default character.

### Result type and attributes

Default logical.

### Result value

- If the strings are of unequal length, the comparison is made as if the shorter string were extended on the right with blanks to the length of the longer string.
- If either string contains a character not in the ASCII character set, the result is undefined.
- The result is true if the strings are equal or if STRING\_A follows STRING\_B in the ASCII collating sequence; otherwise, the result is false. Note that the result is true if both STRING\_A and STRING\_B are of zero length.

### Examples

LGE ('ONE', 'TWO') has the value **.FALSE.**

Specific Name	Argument Type	Result Type	Pass As Arg?
LGE	default character	default logical	yes <b>1</b>

#### Notes:

1. IBM Extension: the ability to pass the name as an argument.

---

## LGT(String\_A, String\_B)

### Purpose

Test whether a string is lexically greater than another string, based on the ASCII collating sequence.

### Class

Elemental function

### Argument type and attributes

STRING\_A must be of type default character.

STRING\_B must be of type default character.

### Result type and attributes

Default logical.

### Result value

- If the strings are of unequal length, the comparison is made as if the shorter string were extended on the right with blanks to the length of the longer string.
- If either string contains a character not in the ASCII character set, the result is undefined.
- The result is true if STRING\_A follows STRING\_B in the ASCII collating sequence; otherwise, the result is false. Note that the result is false if both STRING\_A and STRING\_B are of zero length.

### Examples

LGT ('ONE', 'TWO') has the value **.FALSE.**

Specific Name	Argument Type	Result Type	Pass As Arg?
LGT	default character	default logical	yes <b>1</b>

#### Notes:

1. IBM Extension: the ability to pass the name as an argument.

---

## LLE(String\_A, String\_B)

### Purpose

Test whether a string is lexically less than or equal to another string, based on the ASCII collating sequence.

### Class

Elemental function

### Argument type and attributes

STRING\_A must be of type default character.

STRING\_B must be of type default character.

## Result type and attributes

Default logical.

## Result value

- If the strings are of unequal length, the comparison is made as if the shorter string were extended on the right with blanks to the length of the longer string.
- If either string contains a character not in the ASCII character set, the result is undefined.
- The result is true if the strings are equal or if `STRING_A` precedes `STRING_B` in the ASCII collating sequence; otherwise, the result is false. Note that the result is true if both `STRING_A` and `STRING_B` are of zero length.

## Examples

`LLE ('ONE', 'TWO')` has the value `.TRUE.`.

Specific Name	Argument Type	Result Type	Pass As Arg?
<code>LLE</code>	default character	default logical	yes <b>1</b>

### Notes:

1. IBM Extension: the ability to pass the name as an argument.

---

## LLT(`STRING_A`, `STRING_B`)

### Purpose

Test whether a string is lexically less than another string, based on the ASCII collating sequence.

### Class

Elemental function

### Argument type and attributes

`STRING_A` must be of type default character.

`STRING_B` must be of type default character.

### Result type and attributes

Default logical.

### Result value

- If the strings are of unequal length, the comparison is made as if the shorter string were extended on the right with blanks to the length of the longer string.
- If either string contains a character not in the ASCII character set, the result is undefined.
- The result is true if `STRING_A` precedes `STRING_B` in the ASCII collating sequence; otherwise, the result is false. Note that the result is false if both `STRING_A` and `STRING_B` are of zero length.

## Examples

`LLT ('ONE', 'TWO')` has the value `.TRUE.`.

Specific Name	Argument Type	Result Type	Pass As Arg?
LLT	default character	default logical	yes <b>1</b>

**Notes:**

1. IBM Extension: the ability to pass the name as an argument.

## LOC(X)

IBM Extension

### Purpose

Returns the address of X that can then be used to define an integer **POINTER**.

### Class

Inquiry function

### Argument type and attributes

X is the data object whose address you want to find. It must not be an undefined or disassociated pointer or a parameter. If it is a zero-sized array, it must be storage associated with a non-zero-sized storage sequence. If it is an array section, the storage of the array section must be contiguous.

### Result type and attributes

The result is of type **INTEGER(4)** in 32-bit mode and of type **INTEGER(8)** in 64-bit mode.

### Result value

The result is the address of the data object, or, if X is a pointer, the address of the associated target. The result is undefined if the argument is not valid.

### Examples

```

INTEGER A,B
POINTER (P,I)

P=LOC(A)
P=LOC(B)
END

```

End of IBM Extension

## LOG(X)

### Purpose

Natural logarithm.

### Class

Elemental function

## Argument type and attributes

- X must be of type real or complex.
- If X is real, its value must be greater than zero.
  - If X is complex, its value must not be zero.

## Result type and attributes

Same as X.

## Result value

- It has a value approximating  $\log_e X$ .
- For complex arguments, LOG ((a,b)) approximates LOG (ABS((a,b))) + ATAN2((b,a)).

The `-qxlf2003=signdzerointr` option controls whether you get Fortran 2003 behavior. See `-qxlf2003` in the *XL Fortran Compiler Reference*

Fortran 95

End of Fortran 95

- If the argument type is complex, the result is the principal value of the imaginary part  $\omega$  in the range  $-\pi < \omega \leq \pi$ . If the real part of the argument is less than zero and its imaginary part is zero, the imaginary part of the result approximates  $\pi$ .

Fortran 2003

End of Fortran 2003

- If the argument type is complex, the result is the principal value of the imaginary part  $\omega$  in the range  $-\pi < \omega \leq \pi$ . If the real part of the argument is less than zero and its imaginary part is zero, the imaginary part of the result approximates  $\pi$  if the imaginary part of X is positive real zero. If the imaginary part of X is negative real zero, the imaginary part of the result approximates  $-\pi$ .

## Examples

LOG (10.0) has the value 2.3025851 (approximately).

Specific Name	Argument Type	Result Type	Pass As Arg?
ALOG	default real	default real	yes
DLOG	double precision real	double precision real	yes
QLOG	REAL(16)	REAL(16)	yes <b>1</b>
CLOG	default complex	default complex	yes
CDLOG	double complex	double complex	yes <b>1</b>
ZLOG	double complex	double complex	yes <b>1</b>
CQLOG	COMPLEX(16)	COMPLEX(16)	yes <b>1</b>

### Notes:

1. IBM Extension: the ability to pass the name as an argument.

---

## LOG10(X)

### Purpose

Common logarithm.

### Class

Elemental function

### Argument type and attributes

$X$  must be of type real. The value of  $X$  must be greater than zero.

### Result type and attributes

Same as  $X$ .

### Result value

The result has a value equal to  $\log_{10}X$ .

### Examples

LOG10 (10.0) has the value 1.0.

Specific Name	Argument Type	Result Type	Pass As Arg?
ALOG10	default real	default real	yes
DLOG10	double precision real	double precision real	yes
QLOG10	REAL(16)	REAL(16)	yes <b>1</b>

#### Notes:

1. IBM Extension: the ability to pass the name as an argument.

---

## LOGICAL(L, KIND)

### Purpose

Converts between objects of type logical with different kind type parameter values.

### Class

Elemental function

### Argument type and attributes

$L$  must be of type logical.

**KIND (optional)**  
must be a scalar integer initialization expression.

### Result type and attributes

- Logical.
- If **KIND** is present, the kind type parameter is that specified by **KIND**; otherwise, the kind type parameter is that of the default logical type.

## Result value

The value is that of L.

## Examples

`LOGICAL (L .OR. .NOT. L)` has the value `.TRUE.` and is of type default logical, regardless of the kind type parameter of the logical variable L.

---

## LSHIFT(I, SHIFT)

IBM Extension

### Purpose

Performs a logical shift to the left.

### Class

Elemental function

### Argument type and attributes

**I** must be of type integer.

**SHIFT** must be of type integer. It must be non-negative and less than or equal to `BIT_SIZE(I)`.

### Result type and attributes

Same as I.

### Result value

- The result has the value obtained by shifting the bits of I by SHIFT positions to the left.
- Vacated bits are filled with zeros.
- The bits are numbered 0 to `BIT_SIZE(I)-1`, from right to left.

### Examples

`LSHIFT (3, 1)` has the result 6.

`LSHIFT (3, 2)` has the result 12.

Specific Name	Argument Type	Result Type	Pass As Arg?
LSHIFT	any integer	same as argument	yes

End of IBM Extension

---

## MATMUL(MATRIX\_A, MATRIX\_B, MINDIM)

### Purpose

Performs a matrix multiplication.

### Class

Transformational function



## Argument type and attributes

**MATRIX\_A** is an array with a rank of one or two and a numeric or logical data type.

**MATRIX\_B** is an array with a rank of one or two and a numeric or logical data type. It can be a different numeric type than **MATRIX\_A**, but you cannot use one numeric matrix and one logical matrix.

---

### IBM Extension

---

#### **MINDIM (optional)**

is an integer that determines whether to do the matrix multiplication using the Winograd variation of the Strassen algorithm, which may be faster for large matrices. The algorithm recursively splits the operand matrices into four roughly equal parts, until any submatrix extent is less than **MINDIM**.

**Note:** Strassen's method is not stable for certain row or column scalings of the input matrices. Therefore, for **MATRIX\_A** and **MATRIX\_B** with divergent exponent values, Strassen's method may give inaccurate results.

The significance of the value of **MINDIM** is:

**<=0** does not use the Strassen algorithm at all. This is the default.

**1** is reserved for future use.

**>1** recursively applies the Strassen algorithm as long as the smallest extent of all dimensions in the argument arrays is greater than or equal to this value. To achieve optimal performance you should experiment with the value of **MINDIM** as the optimal value depends on your machine configuration, available memory, and the size, type, and kind type of the arrays.

By default, **MATMUL** employs the conventional  $O(N^3)$  method of matrix multiplication.

If you link the **libpthreads.a** library, the Winograd variation of the  $O(N^{2.81})$  Strassen method is employed under these conditions:

1. **MATRIX\_A** and **MATRIX\_B** are both integer, real, or complex and have the same kind.
2. The program can allocate the needed temporary storage, enough to hold approximately  $(2/3)(N^2)$  elements for square matrices of extent  $N$ .
3. The **MINDIM** argument is less than or equal to the smallest of all extents of **MATRIX\_A** and **MATRIX\_B**.

---

### End of IBM Extension

---

At least one of the arguments must be of rank two. The size of the first or only dimension of **MATRIX\_B** must be equal to the last or only dimension of **MATRIX\_A**.

## Result value

The result is an array. If one of the arguments is of rank one, the result has a rank of one. If both arguments are of rank two, the result has a rank of two.

The data type of the result depends on the data type of the arguments, according to the rules in Table 15 on page 100 and Table 16 on page 104.

If **MATRIX\_A** and **MATRIX\_B** have a numeric data type, the array elements of the result are:

- Value of Element (i,j) = SUM( (row i of **MATRIX\_A**) \* (column j of **MATRIX\_B**) )

If **MATRIX\_A** and **MATRIX\_B** are of type logical, the array elements of the result are:

- Value of Element (i,j) = ANY( (row i of **MATRIX\_A**) .AND. (column j of **MATRIX\_B**) )

## Examples

```
! A is the array | 1 2 3 |, B is the array | 7 10 |
!               | 4 5 6 |                | 8 11 |
!               |         |                | 9 12 |
!
RES = MATMUL(A, B)
! The result is | 50  68 |
!               | 122 167 |
```

### IBM Extension

```
! HUGE_ARRAY and GIGANTIC_ARRAY in this example are
! large arrays of real or complex type, so the operation
! might be faster with the Strassen algorithm.
```

```
RES = MATMUL(HUGE_ARRAY, GIGANTIC_ARRAY, MINDIM=196)
```

### End of IBM Extension

## Related information

### IBM Extension

The compiler will try to use the ESSL library instead of the Fortran run-time library if the **-qessl** compiler option is used. See *XL Fortran Compiler Reference* for more information.

The numerical stability of Strassen's method for matrix multiplication is discussed in:

- "Exploiting Fast Matrix Multiplication Within the Level 3 BLAS", Nicholas J. Higham, *ACM Transactions on Mathematical Software*, Vol. 16, No. 4, December 1990.
- "GEMMW: A portable level 3 BLAS Winograd variant of Strassen's matrix-matrix multiply algorithm", Douglas, C. C., Heroux, M., Shishman, G., and Smith, R. M., *Journal of Computational Physics*, Vol. 110, No. 1, January 1994, pages 1-10.

### End of IBM Extension

---

## MAX(A1, A2, A3, ...)

### Purpose

Maximum value.

### Class

Elemental function

### Argument type and attributes

- A3, ... are optional arguments. Any array that is itself an optional dummy argument must not be passed as an optional argument to this function unless it is present in the calling procedure.
- All the arguments must have the same type, either integer, real or character, and they all must have the same kind type parameter.

### Result type and attributes

If the arguments are of the type character, the result is of type character, and the length of the result is the length of the longest argument. Otherwise the result type is the same as that of the arguments. (Some specific functions return results of a particular type.)

### Result value

The value of the result is that of the largest argument. For character arguments, the comparison is done using the ASCII collating sequence. If the length of the selected argument is shorter than that of the longest argument, the result is extended to the length of the longest argument by inserting blank characters on the right.

### Examples

MAX (-9.0, 7.0, 2.0) has the value 7.0.

MAX ("Z", "BB") has the value "Z".

If you evaluate MAX (10, 3, A), where A is an optional array argument in the calling procedure, PRESENT(A) must be true in the calling procedure.

Specific Name	Argument Type	Result Type	Pass As Arg?
AMAX0	any integer <b>1</b>	default real	no
AMAX1	default real	default real	no
DMAX1	double precision real	double precision real	no
QMAX1	REAL(16)	REAL(16)	no
MAX0	any integer <b>1</b>	same as argument	no
MAX1	any real <b>2</b>	default integer	no

#### Notes:

1. IBM Extension: the ability to specify a nondefault integer argument.
2. IBM Extension: the ability to specify a nondefault real argument.

---

## MAXEXPONENT(X)

### Purpose

Returns the maximum exponent in the model representing numbers of the same type and kind type parameter as the argument.

### Class

Inquiry function

### Argument type and attributes

X must be of type real. It may be scalar or array valued.

### Result type and attributes

Default integer scalar.

### Result value

---

IBM Extension

The result is the following:

type	MAXEXPONENT
-----	-----
real(4)	128
real(8)	1024
real(16)	1024

End of IBM Extension

---

### Examples

---

IBM Extension

MAXEXPONENT(X) = 128 for X of type real(4).

See "Real data model" on page 533.

End of IBM Extension

---

---

## MAXLOC(ARRAY, DIM, MASK, KIND) or MAXLOC(ARRAY, MASK, KIND)

### Purpose

Locates the first element of an array along a dimension that has the maximum value of all elements corresponding to the true values of the mask. MAXLOC will return the index referable to the position of the element using a positive integer.

### Class

Transformational function

## Argument type and attributes

**ARRAY** is an array of type integer, real or character.

Fortran 95

**DIM (optional)**

is a scalar integer in the range  $1 \leq \text{DIM} \leq \text{rank}(\text{ARRAY})$ .

End of Fortran 95

**MASK (optional)**

is of type logical and conforms to **ARRAY** in shape. If it is absent, the default mask evaluation is `.TRUE.`; that is, the entire array is evaluated.

**KIND (optional)**

must be a scalar integer initialization expression.

## Result type and attributes

If **DIM** is absent, the result is an integer array of rank one with a size equal to the rank of **ARRAY**. If **DIM** is present, the result is an integer array of rank  $\text{rank}(\text{ARRAY}) - 1$ , and the shape is  $(s_1, \dots, s_{\text{DIM}-1}, s_{\text{DIM}+1}, \dots, s_n)$ , where  $n$  is the rank of **ARRAY**.

If there is no maximum value, perhaps because the array is zero-sized or the mask array has all `.FALSE.` values or there is no **DIM** argument, the return value is a zero-sized one-dimensional entity. If **DIM** is present, the result shape depends on the rank of **ARRAY**.

If **KIND** is present, the kind of the result is that specified by the value of **KIND**; otherwise, the result is of type default integer.

## Result value

The result indicates the subscript of the location of the maximum masked element of **ARRAY**. If **ARRAY** is of type character, the comparison is done using the ASCII collating sequence. If more than one element is equal to this maximum value, the function finds the location of the first (in array element order). If **DIM** is specified, the result indicates the location of the maximum masked element along each vector of the dimension.

Fortran 95

Because both **DIM** and **MASK** are optional, various combinations of arguments are possible. When the `-qintlog` option is specified with two arguments, the second argument refers to one of the following:

- **MASK** if it is an array of type integer, logical, byte or typeless
- **DIM** if it is a scalar of type integer, byte or typeless
- **MASK** if it is a scalar of type logical

The addition of the **DIM** argument modifies the behavior from XL Fortran Version 3.

End of Fortran 95

## Examples

```
! A is the array | 4 9 8 -8 |
!               | 2 1 -1 5 |
!               | 9 4 -1 9 |
!               | -7 5 7 -3 |
```

```
! Where is the largest element of A?
RES = MAXLOC(A)
! The result is | 3 1 | because 9 is located at A(3,1).
! Although there are other 9s, A(3,1) is the first in
! column-major order.
```

```
! Where is the largest element in each column of A
! that is less than 7?
RES = MAXLOC(A, DIM = 1, MASK = A .LT. 7)
! The result is | 1 4 2 2 | because these are the corresponding
! row locations of the largest value in each column
! that are less than 7 (the values being 4,5,-1,5).
```

Regardless of the defined upper and lower bounds of the array, MAXLOC will determine the lower bound index as '1'. Both MAXLOC and MINLOC index using positive integers. To find the actual index:

```
INTEGER B(-100:100)
! Maxloc views the bounds as (1:201)
! If the largest element is located at index '-49'
I = MAXLOC(B)
! Will return the index '52'
! To return the exact index for the largest element, insert:
INDEX = LBOUND(B) - 1 + I
! Which is: INDEX = (-100) - 1 + 52 = (-49)
PRINT*, B(INDEX)
```

---

## MAXVAL(ARRAY, DIM, MASK) or MAXVAL(ARRAY, MASK)

### Purpose

Returns the maximum value of the elements in the array along a dimension corresponding to the true elements of MASK.

### Class

Transformational function

### Argument type and attributes

**ARRAY** is an array of type integer, real or character.

**DIM (optional)** is an integer scalar in the range  $1 \leq \mathbf{DIM} \leq \text{rank}(\mathbf{ARRAY})$ .

**MASK (optional)** is an array or scalar of type logical that conforms to **ARRAY** in shape. If it is absent, the entire array is evaluated.

### Result value

The result is an array of rank  $\text{rank}(\mathbf{ARRAY})-1$ , with the same data type as **ARRAY**. If **DIM** is missing or if **ARRAY** is of rank one, the result is a scalar. If **ARRAY** is of type character, the length of the result is the same as that of **ARRAY**.

If **DIM** is specified, each element of the result value contains the maximum value of all the elements that satisfy the condition specified by **MASK** along each vector of the dimension **DIM**. The array element subscripts in the result are  $(s_1, s_2, \dots, s_{(DIM-1)}, s_{(DIM+1)}, \dots, s_n)$ , where  $n$  is the rank of **ARRAY** and **DIM** is the dimension specified by **DIM**.

If **DIM** is not specified, the function returns the maximum value of all applicable elements.

If **ARRAY** is of type character, all comparisons are done using the ASCII collating sequence.

If **ARRAY** is zero-sized or the mask array has all **.FALSE.** values, then:

- if **ARRAY** is of type integer or real, the result value is the negative number of the largest magnitude, of the same type and kind type as **ARRAY**.
- if **ARRAY** is of type character, each character of the result has the value of **CHAR(0)**.

Because both **DIM** and **MASK** are optional, various combinations of arguments are possible. When the **-qintlog** option is specified with two arguments, the second argument refers to one of the following:

- **MASK** if it is an array of type integer, logical, byte or typeless
- **DIM** if it is a scalar of type integer, byte or typeless
- **MASK** if it is a scalar of type logical

## Examples

```
! A is the array | -41 33 25 |
!               | 12 -61 11 |

! What is the largest value in the entire array?
RES = MAXVAL(A)
! The result is 33

! What is the largest value in each column?
RES = MAXVAL(A, DIM=1)
! The result is | 12 33 25 |

! What is the largest value in each row?
RES = MAXVAL(A, DIM=2)
! The result is | 33 12 |

! What is the largest value in each row, considering only
! elements that are less than 30?
RES = MAXVAL(A, DIM=2, MASK = A .LT. 30)
! The result is | 25 12 |
```

---

## MERGE(TSOURCE, FSOURCE, MASK)

### Purpose

Selects between two values, or corresponding elements in two arrays. A logical mask determines whether to take each result element from the first or second argument.

### Class

Elemental function

## Argument type and attributes

<b>TSOURCE</b>	is the source array to use when the corresponding element in the mask is true. It is an expression of any data type.
<b>FSOURCE</b>	is the source array to use when the corresponding element in the mask is false. It must have the same data type and type parameters as <b>tsource</b> . It must conform in shape to <b>tsource</b> .
<b>MASK</b>	is a logical expression that conforms to <b>TSOURCE</b> and <b>FSOURCE</b> in shape.

## Result value

The result has the same shape and data type as **TSOURCE** and **FSOURCE**.

For each element in the result, the value of the corresponding element in **MASK** determines whether the value is taken from **TSOURCE** (if true) or **FSOURCE** (if false).

## Examples

```
! TSOURCE is | A D G |, FSOURCE is | a d g |,
!           | B E H |,           | b e h |,
!           | C F I |           | c f i |
!
! and MASK is the array | T T T |
!                   | F F F |
!                   | F F F |
!
! Take the top row of TSOURCE, and the remaining elements
! from FSOURCE.
      RES = MERGE(TSOURCE, FSOURCE, MASK)
! The result is | A D G |
!             | b e h |
!             | c f i |
!
! Evaluate IF (X .GT. Y) THEN
!     RES=6
! ELSE
!     RES=12
! END IF
! in a more concise form.
      RES = MERGE(6, 12, X .GT. Y)
```

---

## MIN(A1, A2, A3, ...)

### Purpose

Minimum value.

### Class

Elemental function

## Argument type and attributes

- **A3, ...** are optional arguments. Any array that is itself an optional dummy argument must not be passed as an optional argument to this function unless it is present in the calling procedure.
- All the arguments must have the same type, either integer, real, or character and they all must have the same kind type parameter.



## Result type and attributes

If the arguments are of the type character, the result is of type character, and the length of the result is the length of the longest argument. Otherwise, the result is the same as that of the arguments. (Some specific functions return results of a particular type.)

## Result value

The value of the result is that of the smallest argument. For character arguments, the comparison is done using the ASCII collating sequence. If the length of the selected argument is shorter than that of the longest argument, the result is extended to the length of the longest argument by inserting blank characters on the right.

## Examples

MIN (-9.0, 7.0, 2.0) has the value -9.0

MIN ("A", "YY") has the value "A"

If you evaluate MIN (10, 3, A), where A is an optional array argument in the calling procedure, PRESENT(A) must be true in the calling procedure.

Specific Name	Argument Type	Result Type	Pass As Arg?
AMIN0	any integer*	default real	no
AMIN1	default real	default real	no
DMIN1	double precision real	double precision real	no
QMIN1	REAL(16)	REAL(16)	no
MIN0	any integer*	same as argument	no
MIN1	any real*	default integer	no

Note: \*A non-default argument is an IBM extension.

---

## MINEXPONENT(X)

### Purpose

Returns the minimum (most negative) exponent in the model representing the numbers of the same type and kind type parameter as the argument.

### Class

Inquiry function

### Argument type and attributes

X must be of type real. It may be scalar or array valued.

### Result type and attributes

Default integer scalar.

## Result value

### IBM Extension

The result is the following:

type	MINEXPONENT
real(4)	- 125
real(8)	-1021
real(16)	-968

End of IBM Extension

## Examples

### IBM Extension

MINEXPONENT(X) = -125 for X of type real(4).

See “Real data model” on page 533.

End of IBM Extension

---

## MINLOC(ARRAY, DIM, MASK, KIND) or MINLOC(ARRAY, MASK, KIND)

### Purpose

Locates the first element of an array along a dimension that has the minimum value of all elements corresponding to the true values of the mask. MINLOC will return the index referable to the position of the element using a positive integer.

### Class

Transformational function

### Argument type and attributes

#### ARRAY

is an array of type integer, real or character.

### Fortran 95

#### DIM (optional)

is a scalar integer in the range  $1 \leq \text{DIM} \leq n$ , where  $n$  is the rank of **ARRAY**.

End of Fortran 95

#### MASK (optional)

is of type logical and conforms to **ARRAY** in shape. If it is absent, the default mask evaluation is `.TRUE.`; that is, the entire array is evaluated.

#### KIND (optional)

must be a scalar integer initialization expression.

## Result type and attributes

If **DIM** is absent, the result is an integer array of rank one with a size equal to the rank of **ARRAY**. If **DIM** is present, the result is an integer array of rank  $\text{rank}(\text{ARRAY})-1$ , and the shape is  $(s_1, \dots, s_{\text{DIM}-1}, s_{\text{DIM}+1}, \dots, s_n)$ , where  $n$  is the rank of **ARRAY**.

If there is no minimum value, perhaps because the array is zero-sized or the mask array has all **.FALSE.** values or there is no **DIM** argument, the return value is a zero-sized one-dimensional entity. If **DIM** is present, the result shape depends on the rank of **ARRAY**.

If **KIND** is present, the kind of the result is that specified by the value of **KIND**; otherwise, the result is of type default integer.

## Result value

The result indicates the subscript of the location of the minimum masked element of **ARRAY**. If **ARRAY** is of type character, the comparison is done using the ASCII collating sequence. If more than one element is equal to this minimum value, the function finds the location of the first (in array element order). If **DIM** is specified, the result indicates the location of the minimum masked element along each vector of the dimension.

### Fortran 95

Because both **DIM** and **MASK** are optional, various combinations of arguments are possible. When the **-qintlog** option is specified with two arguments, the second argument refers to one of the following:

- **MASK** if it is an array of type integer, logical, byte or typeless
- **DIM** if it is a scalar of type integer, byte or typeless
- **MASK** if it is a scalar or type logical

The addition of the **DIM** argument modifies the behavior from XL Fortran Version 3.

### End of Fortran 95

## Examples

```
! A is the array | 4 9 8 -8 |
!               | 2 1 -1 5  |
!               | 9 4 -1 9  |
!               | -7 5 7 -3 |
```

```
! Where is the smallest element of A?
RES = MINLOC(A)
! The result is | 1 4 | because -8 is located at A(1,4).
```

```
! Where is the smallest element in each row of A that
! is not equal to -7?
RES = MINLOC(A, DIM = 2, MASK = A .NE. -7)
! The result is | 4 3 3 4 | because these are the
! corresponding column locations of the smallest value
! in each row not equal ! to -7 (the values being
! -8,-1,-1,-3).
```

Regardless of the defined upper and lower bounds of the array, MINLOC will determine the lower bound index as '1'. Both MAXLOC and MINLOC index using positive integers. To find an actual index:

```
INTEGER B(-100:100)
! Minloc views the bounds as (1:201)
! If the smallest element is located at index '-49'
  I = MINLOC(B)
! Will return the index '52'
! To return the exact index for the smallest element, insert:
  INDEX = LBOUND(B) - 1 + I
! Which is: INDEX = (-100) - 1 + 52 = (-49)
PRINT*, B(INDEX)
```

---

## MINVAL(ARRAY, DIM, MASK) or MINVAL(ARRAY, MASK)

### Purpose

Returns the minimum value of the elements in the array along a dimension corresponding to the true elements of MASK.

### Class

Transformational function

### Argument type and attributes

**ARRAY** is an array of type integer, real or character.

**DIM (optional)** is an integer scalar in the range  $1 \leq \text{DIM} \leq \text{rank}(\text{ARRAY})$ .

**MASK (optional)** is an array or scalar of type logical that conforms to **ARRAY** in shape. If it is absent, the entire array is evaluated.

### Result value

The result is an array of rank  $\text{rank}(\text{ARRAY})-1$ , with the same data type as **ARRAY**. If **DIM** is missing or if **ARRAY** is of rank one, the result is a scalar. If **ARRAY** is of type character, the length of the result is the same as that of **ARRAY**.

If **DIM** is specified, each element of the result value contains the minimum value of all the elements that satisfy the condition specified by **MASK** along each vector of the dimension **DIM**. The array element subscripts in the result are  $(s_1, s_2, \dots, s_{(\text{DIM}-1)}, s_{(\text{DIM}+1)}, \dots, s_n)$ , where  $n$  is the rank of **ARRAY** and **DIM** is the dimension specified by **DIM**.

If **DIM** is not specified, the function returns the minimum value of all applicable elements.

If **ARRAY** is of type character, all comparisons are done using the ASCII collating sequence.

If **ARRAY** is zero-sized or the mask array has all **.FALSE.** values, then:

- If **ARRAY** is of type integer or real, the result value is the positive number of the largest magnitude, of the same type and kind type as **ARRAY**.
- If **ARRAY** is of type character, each character of the result has the value of **CHAR(127)**.

Because both **DIM** and **MASK** are optional, various combinations of arguments are possible. When the **-qintlog** option is specified with two arguments, the second argument refers to one of the following:

- **MASK** if it is an array of type integer, logical, byte or typeless
- **DIM** if it is a scalar of type integer, byte or typeless
- **MASK** if it is a scalar of type logical

## Examples

```
! A is the array | -41 33 25 |
!               | 12 -61 11 |

! What is the smallest element in A?
RES = MINVAL(A)
! The result is -61

! What is the smallest element in each column of A?
RES = MINVAL(A, DIM=1)
! The result is | -41 -61 11 |

! What is the smallest element in each row of A?
RES = MINVAL(A, DIM=2)
! The result is | -41 -61 |

! What is the smallest element in each row of A,
! considering only those elements that are
! greater than zero?
RES = MINVAL(A, DIM=2, MASK = A .GT.0)
! The result is | 25 11 |
```

---

## MOD(A, P)

### Purpose

Remainder function.

### Class

Elemental function

### Argument type and attributes

**A** must be of type integer or real.

**P**

must be of the same type and kind type parameter as **A**.

IBM Extension

The kind type parameters can be different if the compiler option `-qport=mod` is specified.

End of IBM Extension

### Result type and attributes

Same as **A**.

## Result value

- If  $P \neq 0$ , the value of the result is  $A - \text{INT}(A/P) * P$ .
- If  $P = 0$ , the result is undefined.

## Examples

MOD (3.0, 2.0) has the value 1.0.  
MOD (8, 5) has the value 3.  
MOD (-8, 5) has the value -3.  
MOD (8, -5) has the value 3.  
MOD (-8, -5) has the value -3.

Specific Name	Argument Type	Result Type	Pass As Arg?
MOD	any integer	same as argument	yes
AMOD	default real	default real	yes
DMOD	double precision real	double precision real	yes
QMOD	REAL(16)	REAL(16)	yes

### Notes:

1. IBM Extension: the ability to pass the name as an argument.

## Related information

For information on alternative behavior for **MOD** when porting programs to XL Fortran, see the **-qport** compiler option in the *XL Fortran Compiler Reference*.

---

## MODULO(A, P)

### Purpose

Modulo function.

### Class

Elemental function

### Argument type and attributes

- A      must be of type integer or real.  
P      must be of the same type and kind type parameter as A.

### Result type and attributes

Same as A.

### Result value

- Case (i): A is of type integer. If  $P \neq 0$ , MODULO (A, P) has the value R such that  $A = Q * P + R$ , where Q is an integer.  
If  $P > 0$ , the inequalities  $0 \leq R < P$  hold.  
If  $P < 0$ ,  $P < R \leq 0$  hold.  
If  $P = 0$ , the result is undefined.
- Case (ii): A is of type real. If  $P \neq 0$ , the value of the result is  $A - \text{FLOOR}(A / P) * P$ .  
If  $P = 0$ , the result is undefined.

## Examples

MODULO (8, 5) has the value 3.  
MODULO (-8, 5) has the value 2.  
MODULO (8, -5) has the value -2.  
MODULO (-8, -5) has the value -3.

---

## MOVE\_ALLOC(FROM, TO)

Fortran 2003

### Purpose

Allows you to move allocation status, dynamic type, type parameter values, bounds information, and values from one object to another.

### Class

subroutine

### Argument type and attributes

#### FROM

An **INTENT(INOUT)** dummy argument that must be an allocatable object. It may be scalar or an array.

#### TO

An **INTENT(OUT)** dummy argument that must be an allocatable object. It must be type-compatible and have the same rank as **FROM**. It must be polymorphic if **FROM** is polymorphic.

### Result value

If **FROM** is unallocated, the allocation status of **TO** is unallocated.

If **FROM** is allocated, **TO** is allocated with the same dynamic type, type parameters, array bounds, and value as those of **FROM**.

If **TO** has the **TARGET** attribute, any pointer associated with **FROM** is correspondingly associated with **TO**.

If **TO** does not have the **TARGET** attribute, the association status of any pointer that was associated with **FROM** when you call **MOVE\_ALLOC** becomes undefined.

End of Fortran 2003

---

## MVBITS(FROM, FROMPOS, LEN, TO, TOPOS)

### Purpose

Copies a sequence of bits from one data object to another.

### Class

Elemental subroutine

### Argument type and attributes

**FROM** must be of type integer. It is an **INTENT(IN)** argument.

<b>FROMPOS</b>	must be of type integer and nonnegative. It is an <b>INTENT(IN)</b> argument. FROMPOS + LEN must be less than or equal to BIT_SIZE (FROM).
<b>LEN</b>	must be of type integer and nonnegative. It is an <b>INTENT(IN)</b> argument.
<b>TO</b>	must be a variable of type integer with the same kind type parameter value as FROM and may be the same variable as FROM. It is an <b>INTENT(INOUT)</b> argument. TO is set by copying the sequence of bits of length LEN, starting at position FROMPOS of FROM to position TOPOS of TO. No other bits of TO are altered. On return, the LEN bits of TO starting at TOPOS are equal to the value that the LEN bits of FROM starting at FROMPOS had on entry.  The bits are numbered 0 to BIT_SIZE(I)-1, from right to left.
<b>TOPOS</b>	must be of type integer and nonnegative. It is an <b>INTENT(IN)</b> argument. TOPOS + LEN must be less than or equal to BIT_SIZE (TO).

## Examples

If TO has the initial value 6, the value of TO is 5 after the statement  
CALL MVBITS (7, 2, 2, TO, 0)

See "Integer bit model" on page 531.

## NEAREST(X,S)

### Purpose

Returns the nearest different processor-representable number in the direction indicated by the sign of S (toward positive or negative infinity).

### Class

Elemental function

### Argument type and attributes

X must be of type real.

S must be of type real and not equal to zero.

### Result type and attributes

Same as X.

### Result value

The result is the machine number different from and nearest to X in the direction of the infinity with the same sign as S.



## Examples

IBM Extension

NEAREST (3.0, 2.0) = 3.0 + 2.0<sup>(-22)</sup>. See “Real data model” on page 533.

End of IBM Extension

---

## NEW\_LINE(A)

Fortran 2003

### Purpose

The `NEW_LINE` intrinsic returns a new line character.

### Class

Inquiry function

### Argument type and attributes

`A` must be a scalar or an array of type character.

### Result type and attributes

Character scalar of length one.

### Result value

The result is the same as `ACHAR(10)`.

## Examples

The following example uses the `NEW_LINE` intrinsic in list-directed output:

```
character(1) c
print *, 'The first sentence.', NEW_LINE(c), 'The second sentence.'
```

Expected Output:

```
The first sentence.
The second sentence.
```

The following example passes a character literal constant to the `NEW_LINE` intrinsic:

```
character(100) line
line = 'IBM' // NEW_LINE('Fortran') // 'XL Fortran Compiler'
```

Expected Output:

```
IBM
XL Fortran Compiler
```

End of Fortran 2003

---

## NINT(A, KIND)

### Purpose

Nearest integer.

### Class

Elemental function

### Argument type and attributes

A must be of type real.

KIND (optional)  
must be a scalar integer initialization expression.

### Result type and attributes

- Integer.
- If **KIND** is present, the kind type parameter is that specified by **KIND**; otherwise, the kind type parameter is that of the default integer type.

### Result value

- If  $A > 0$ , NINT (A) has the value INT (A + 0.5).
- If  $A \leq 0$ , NINT (A) has the value INT (A - 0.5).
- The result is undefined if its value cannot be represented in the specified integer type.

### Examples

NINT (2.789) has the value 3. NINT (2.123) has the value 2.

Specific Name	Argument Type	Result Type	Pass As Arg?
NINT	default real	default integer	yes
IDNINT	double precision real	default integer	yes
IQNINT	REAL(16)	default integer	yes <b>1</b>

#### Notes:

1. IBM Extension

---

## NOT(I)

### Purpose

Performs a bitwise complement of integer.

### Class

Elemental function

### Argument type and attributes

I must be of type integer.

## Result type and attributes

Same as I.

## Result value

The result has the value obtained by complementing I bit-by-bit according to the following table:

<i>i</i> th bit of I	<i>i</i> th bit of NOT (I)
1	0
0	1

The bits are numbered 0 to BIT\_SIZE(I)-1, from right to left.

## Examples

If I is represented by the string of bits 01010101, NOT (I) has the string of bits 10101010. See “Integer bit model” on page 531.

Specific Name	Argument Type	Result Type	Pass As Arg?
NOT	any integer	same as argument	yes <b>1</b>

### Notes:

1. IBM Extension.

---

## NULL(MOLD)

Fortran 95

## Purpose

This function returns a pointer or designates an unallocated allocatable component of a structure constructor. The association status of the pointer is disassociated.

You must use the function without the **MOLD** argument in any of the following:

- initialization of an object in a declaration
- default initialization of a component
- in a **DATA** statement
- in a **STATIC** statement

You can use the function with or without the **MOLD** argument in any of the following:

- in the **PARAMETER** attribute
- on the right side of a pointer assignment
- in a structure constructor
- as an actual argument

## Class

Transformational function.

## Argument type and attributes

### **MOLD** (optional)

must be a pointer or allocatable. It can be of any type or can be a procedure pointer. The association status of the pointer can be undefined, disassociated, or associated. If it has an association status of associated, the target may be undefined. If **MOLD** is allocatable its allocation status can be allocated or unallocated.

## Result type and attributes

If **MOLD** is present, the result's characteristics are the same as those of **MOLD**. If **MOLD** is not present, the entity's type, type parameter and rank are determined as follows:

- same as the pointer that appears on the left hand side, for a pointer assignment
- same as the object, when initializing an object in a declaration
- same as the component, in a default initialization for a component
- same as the corresponding component, in a structure constructor
- same as the corresponding dummy argument, as an actual argument
- same as the corresponding pointer object, in a **DATA** statement
- same as the corresponding pointer object, in a **STATIC** statement

## Result value

The result is a pointer with disassociated association status or an unallocated allocatable entity.

## Examples

```
! Using NULL() as an actual argument.
INTERFACE
  SUBROUTINE FOO(I, PR)
    INTEGER I
    REAL, POINTER:: PR
  END SUBROUTINE FOO
END INTERFACE

CALL FOO(5, NULL())
```

End of Fortran 95

---

## NUM\_PARTHDS()

IBM Extension

### Purpose

Returns the number of parallel Fortran threads the run time should create during execution of a program. This value is set by using the **PARTHDS** run-time option. If the user does not set the **PARTHDS** run-time option, the run time will set a default value for **PARTHDS**. In doing so, the run time may consider the following when setting the option:

- The number of processors on the machine
- The value specified in the run-time option **USRTHDS**.

## Class

Inquiry function

## Result value

Default scalar integer

If the compiler option **-qsmp** has not been specified, then **NUM\_PARTHDS** will always return a value of 1.

## Examples

```
I = NUM_PARTHDS()  
IF (I == 1) THEN  
  CALL SINGLE_THREAD_ROUTINE()  
ELSE  
  CALL MULTI_THREAD_ROUTINE()
```

Specific Name	Result Type	Pass As Arg?
NUM_PARTHDS	default scalar integer	no

## Related information

See the **parthds** and **XLSPMPOPTS** runtime options in the *XL Fortran Optimization and Programming Guide*.

End of IBM Extension

---

## NUMBER\_OF\_PROCESSORS(DIM)

IBM Extension

## Purpose

Returns a scalar of type default integer whose value is always 1. This intrinsic ensures compatibility with programs written for High Performance Fortran (HPF) environments.

## Class

System inquiry function

## Argument type and attributes

### DIM (optional)

must be a scalar integer and have a value of 1 (the rank of the processor array).

## Result type and attributes

Default scalar integer which always has a value of 1.

## Examples

```
I = NUMBER_OF_PROCESSORS()      ! 1  
J = NUMBER_OF_PROCESSORS(DIM=1) ! 1
```

End of IBM Extension

---

## NUM\_USRTHDS()

IBM Extension

### Purpose

Returns the number of threads that will be explicitly created by the user during execution of the program. This value is set by using the **USRTHDS** run-time option.

### Class

Inquiry function

### Result value

Default scalar integer

If the value has not been explicitly set using the **USRTHDS** run-time option, the default value is 0.

Specific Name	Result Type	Pass As Arg?
NUM_USRTHDS	default scalar integer	no

### Related information

See the **usrthds** and the **XLSMPOPTS** runtime options in the *XL Fortran Optimization and Programming Guide*.

End of IBM Extension

---

## PACK(ARRAY, MASK, VECTOR)

### Purpose

Takes some or all elements from an array and packs them into a one-dimensional array, under the control of a mask.

### Class

Transformational function

### Argument type and attributes

#### ARRAY

is the source array, whose elements become part of the result. It can have any data type.

#### MASK

must be of type logical and must be conformable with **ARRAY**. It determines which elements are taken from the source array. If it is a scalar, its value applies to all elements in **ARRAY**.

#### VECTOR (optional)

is a padding array whose elements are used to fill out the result if there are not enough elements selected by the mask. It is a one-dimensional array that has the same data type and type parameter as **ARRAY** and at least as many elements as there are true values in **MASK**. If **MASK** is a

scalar with a value of `.TRUE.`, **VECTOR** must have at least as many elements as there are array elements in **ARRAY**.

## Result value

The result is always a one-dimensional array with the same data type and type parameter as **ARRAY**.

The size of the result depends on the optional arguments:

- If **VECTOR** is specified, the size of the resultant array equals the size of **VECTOR**.
- Otherwise, it equals the number of true array elements in **MASK**, or the number of elements in **ARRAY** if **MASK** is a scalar with a value of `.TRUE.`.

The array elements in **ARRAY** are taken in array element order to form the result. If the corresponding array element in **MASK** is `.TRUE.`, the element from **ARRAY** is placed at the end of the result.

If any elements remain empty in the result (because **VECTOR** is present, and has more elements than there are `.TRUE.` values in **mask**), the remaining elements in the result are set to the corresponding values from **VECTOR**.

## Examples

```
! A is the array | 0 7 0 |
!               | 1 0 3 |
!               | 4 0 0 |

! Take only the non-zero elements of this sparse array.
! If there are less than six, fill in -1 for the rest.
RES = PACK(A, MASK= A .NE. 0, VECTOR=(-1,-1,-1,-1,-1,-1/))
! The result is (/ 1, 4, 7, 3, -1, -1 /).
```

---

## POPCNT(I)

IBM Extension

### Purpose

Population count.

Counts the number of set bits in a data object.

### Class

Elemental function.

### Argument type and attributes

- I** An **INTENT(IN)** argument of type **BYTE**, **INTEGER**, **LOGICAL**, or **REAL**. If the argument is of type **REAL**, it must not be **REAL(16)**.

## Result type and attributes

Default integer.

## Result value

The number of bits set to ON or 1.

## Examples

INTEGER	BIT REPRESENTATION	POPCNT
0	0000	0
1	0001	1
2	0010	1
3	0011	2
4	0100	1

## Related information

Data representation models

End of IBM Extension

---

## POPPAR(I)

IBM Extension

## Purpose

Population parity.

Determines the parity for a data object.

## Class

Elemental function.

## Argument type and attributes

I An **INTENT(IN)** argument of type **BYTE**, **INTEGER**, **LOGICAL**, or **REAL**.  
If the argument is of type **REAL**, it must not be **REAL(16)**.

## Result type and attributes

Default integer.

## Result value

Returns 1 if there are an odd number of bits set.

Returns 0 if there are an even number of bits set.

## Examples

INTEGER	BIT REPRESENTATION	POPPAR
---------	--------------------	--------



0	0000	0
1	0001	1
2	0010	1
3	0011	0
4	0100	1

## Related information

Data representation models

End of IBM Extension

---

## PRECISION(X)

### Purpose

Returns the decimal precision in the model representing real numbers with the same kind type parameter as the argument.

### Class

Inquiry function

### Argument type and attributes

X must be of type real or complex. It may be scalar or array valued.

### Result type and attributes

Default integer scalar.

### Result value

The result is:

$\text{INT}(\text{DIGITS}(X) - 1) * \text{LOG}_{10}(2)$

IBM Extension

Therefore,

Type	Precision
real(4) , complex(4)	6
real(8) , complex(8)	15
real(16) , complex(16)	31

End of IBM Extension

### Examples

IBM Extension

$\text{PRECISION}(X) = \text{INT}((24 - 1) * \text{LOG}_{10}(2.)) = \text{INT}(6.92 \dots) = 6$  for X of type

real(4). See “Real data model” on page 533.

End of IBM Extension

---

## PRESENT(A)

### Purpose

Determine whether an optional argument is present. If it is not present, you may only pass it as an optional argument to another procedure or pass it as an argument to PRESENT.

### Class

Inquiry function

### Argument type and attributes

A is the name of an optional dummy argument that is accessible in the procedure in which the PRESENT function reference appears.

### Result type and attributes

Default logical scalar.

### Result value

The result is .TRUE. if the actual argument is present (that is, if it was passed to the current procedure in the specified dummy argument), and .FALSE. otherwise.

### Examples

```
SUBROUTINE SUB (X, Y)
  REAL, OPTIONAL :: Y
  IF (PRESENT (Y)) THEN
! In this section, we can use y like any other variable.
    X = X + Y
    PRINT *, Sqrt(Y)
  ELSE
! In this section, we cannot define or reference y.
    X = X + 5
! We can pass it to another procedure, but only if
! sub2 declares the corresponding argument as optional.
    CALL SUB2 (Z, Y)
  ENDF
END SUBROUTINE SUB
```

### Related information

“OPTIONAL” on page 407

---

## PROCESSORS\_SHAPE()

IBM Extension

### Purpose

Returns a zero-sized array. This intrinsic ensures compatibility with programs written for High Performance Fortran (HPF) environments.

## Class

System inquiry function

## Result type and attributes

Default integer array of rank one, whose size is equal to the rank of the processor array. In a uniprocessor environment, the result is a zero-sized vector.

## Result value

The value of the result is the shape of the processor array.

## Examples

```
I=PROCESSORS_SHAPE()  
! Zero-sized vector of type default integer
```

End of IBM Extension

---

## PRODUCT(ARRAY, DIM, MASK) or PRODUCT(ARRAY, MASK)

### Purpose

Multiplies together all elements in an entire array, or selected elements from all vectors in a specified dimension of an array.

### Class

Transformational function

### Argument type and attributes

**ARRAY** is an array with a numeric data type.

**DIM (optional)**

is an integer scalar (a specified dimension of ARRAY) in the range  $1 \leq \text{DIM} \leq \text{rank}(\text{ARRAY})$ .

**MASK (optional)**

is a logical expression that conforms with ARRAY in shape. If MASK is a scalar, the scalar value applies to all elements in ARRAY.

### Result value

If DIM is present, the result is an array of rank  $\text{rank}(\text{ARRAY})-1$  and the same data type and kind type parameter as ARRAY. If DIM is missing, or if MASK has a rank of one, the result is a scalar.

The result is calculated by one of the following methods:

#### Method 1:

If only ARRAY is specified, the result is the product of all its array elements. If ARRAY is a zero-sized array, the result is equal to one.

#### Method 2:

If ARRAY and MASK are both specified, the result is the product of those

array elements of ARRAY that have a corresponding true array element in MASK. If MASK has no elements with a value of .TRUE., the result is equal to one.

**Method 3:**

If DIM is also specified and ARRAY has a rank of one, the result is a scalar equal to the product of all elements of ARRAY that have a corresponding .TRUE. array element in MASK.

If DIM is also specified and ARRAY has rank greater than one, the result is a new array in which dimension DIM has been eliminated. Each new array element is the product of elements from a corresponding vector within ARRAY. The index values of that vector, in all dimensions except DIM, match those of the output element. The output element is the product of those vector elements that have a corresponding .TRUE. array element in MASK.

**Fortran 95**

Because both DIM and MASK are optional, various combinations of arguments are possible. When the **-qintlog** option is specified with two arguments, the second argument refers to one of the following:

- MASK if it is an array of type integer, logical, byte or typeless
- DIM if it is a scalar of type integer, byte or typeless
- MASK if it is a scalar of type logical

**End of Fortran 95**

**Examples**

- Method 1:

```
! Multiply all elements in an array.
RES = PRODUCT( (/2, 3, 4/) )
! The result is 24 because (2 * 3 * 4) = 24.
```

```
! Do the same for a two-dimensional array A, where
! A is the array | 2 3 4 |
!               | 4 5 6 |
RES = PRODUCT(A)
! The result is 2880. All elements are multiplied.
```

- Method 2:

```
! A is the array (/ -3, -7, -5, 2, 3 /)
! Multiply all elements of the array that are > -5.
RES = PRODUCT(A, MASK = A .GT. -5)
! The result is -18 because (-3 * 2 * 3) = -18.
```

- Method 3:

```
! A is the array | -2 5 7 |
!               | 3 -4 3 |
! Find the product of each column in A.
RES = PRODUCT(A, DIM = 1)
! The result is | -6 -20 21 | because (-2 * 3) = -6
!                                     ( 5 * -4 ) = -20
!                                     ( 7 * 3 ) = 21
```

```
! Find the product of each row in A.
RES = PRODUCT(A, DIM = 2)
! The result is | -70 -36 |
! because (-2 * 5 * 7) = -70
!         ( 3 * -4 * 3) = -36
```

```

! Find the product of each row in A, considering
! only those elements greater than zero.
      RES = PRODUCT(A, DIM = 2, MASK = A .GT. 0)
! The result is | 35 9 | because ( 5 * 7) = 35
!                                     (3 * 3) = 9

```

---

## QCMPLEX(X, Y)

---

### IBM Extension

---

#### Purpose

Convert to extended complex type.

#### Class

Elemental function

#### Argument type and attributes

**X** must be of type integer, real, or complex.

**Y (optional)** must be of type integer or real. It must not be present if X is of type complex.

#### Result type and attributes

It is of type extended complex.

#### Result value

- If Y is absent and X is not complex, it is as if Y were present with the value of zero.
- If Y is absent and X is complex, it is as if Y were present with the value AIMAG(X) and X were present with the value REAL(X).
- QCMPLEX(X, Y) has the complex value whose real part is REAL(X, KIND=16) and whose imaginary part is REAL(Y, KIND=16).

#### Examples

QCMPLEX (-3) has the value (-3.0Q0, 0.0Q0).

Specific Name	Argument Type	Result Type	Pass As Arg?
QCMPLEX	REAL(16)	COMPLEX(16)	no

#### Related information

“CMPLX(X, Y, KIND) ” on page 553, “DCMPLX(X, Y) ” on page 564.

---

End of IBM Extension

---

---

## QEXT(A)

IBM Extension

### Purpose

Convert to extended precision real type.

### Class

Elemental function

### Argument type and attributes

A must be of type integer, or real.

### Result type and attributes

Extended precision real.

### Result value

- If A is of type extended precision real,  $QEXT(A) = A$ .
- If A is of type integer or real, the result is the exact extended precision representation of A.

### Examples

QEXT (-3) has the value -3.0Q0.

Specific Name	Argument Type	Result Type	Pass As Arg?
QFLOAT	any integer	REAL(16)	no
QEXT	default real	REAL(16)	no
QEXTD	double precision real	REAL(16)	no

End of IBM Extension

---

## RADIX(X)

### Purpose

Returns the base of the model representing numbers of the same type and kind type parameter as the argument.

### Class

Inquiry function



### Argument type and attributes

X must be of type integer or real. It may be scalar or array valued.

### Result type and attributes

Default integer scalar.

## Result value

The result is the base of the model representing numbers of the same kind and type as X.  The result is always 2.  See the models under “Data representation models” on page 531.

---

## RAND()

---

### IBM Extension

---

### Purpose

Not recommended. Generates uniform random numbers, positive real numbers greater than or equal to 0.0 and less than 1.0. Instead, use the standards conforming **RANDOM\_NUMBER(HARVEST)** intrinsic subroutine.

### Class

None (does not correspond to any of the defined categories).

### Result type and attributes

real(4) scalar.

### Related information

“SRAND(SEED)” on page 657 can be used to specify a seed value for the random number sequence.

If the function result is assigned to an array, all array elements receive the same value.

### Examples

The following is an example of a program using the **RAND** function.

```
DO I = 1, 5
  R = RAND()
  PRINT *, R
ENDDO
END
```

The following is sample output generated by the above program:

```
0.2251586914
0.8285522461
0.6456298828
0.2496948242
0.2215576172
```

This function only has a specific name.

---

### End of IBM Extension

---

---

## RANDOM\_NUMBER(HARVEST)

### Purpose

Returns one pseudo-random number or an array of pseudo-random numbers from the uniform distribution over the range  $0 \leq x < 1$ .

If you link the **libpthreads.a** library, a parallel implementation of random number generation is employed which improves performance on SMP machines. The number of threads used can be controlled by the **intrinsicheads=num** run-time option.

## Class

Subroutine

## Argument type and attributes

**HARVEST** must be of type real. It is an **INTENT(OUT)** argument. It may be a scalar or array variable. It is set to pseudo-random numbers from the uniform distribution in the interval  $0 \leq x < 1$ .

## Examples

```
REAL X, Y (10, 10)
! Initialize X with a pseudo-random number
CALL RANDOM_NUMBER (HARVEST = X)
CALL RANDOM_NUMBER (Y)
! X and Y contain uniformly distributed random numbers
```

---

## RANDOM\_SEED(SIZE, PUT, GET, GENERATOR)

### Purpose

Restarts or queries the pseudo-random number generator used by **RANDOM\_NUMBER**.

### Class

Subroutine

### Argument type and attributes

There must either be exactly one or no arguments present.

#### **SIZE (optional)**

must be scalar and of type default integer. It is an **INTENT(OUT)** argument. It is set to the number of default type integers (N) that are needed to hold the value of the seed, which is an 8-byte variable.

#### **PUT (optional)**

must be a default integer array of rank one and size  $\geq N$ . It is an **INTENT(IN)** argument. The seed for the current generator is transferred from it.

#### **GET (optional)**

must be a default integer array of rank one and size  $\geq N$ . It is an **INTENT(OUT)** argument. The seed for the current generator is transferred to it.

---

### IBM Extension

---

#### **GENERATOR (optional)**

must be a scalar and of type default integer. It is an **INTENT(IN)** argument. Its value determines the random number generator to be



used subsequently. The value must be either 1 or 2.

End of IBM Extension

IBM Extension

Random\_seed allows the user to toggle between two random number generators. Generator 1 is the default. Each generator maintains a private seed and normally resumes its cycle after the last number it generated. A valid seed must be a whole number between 1.0 and 2147483647.0 (2.0\*\*31-1) for Generator 1 and between 1.0 and 281474976710656.0 (2.0\*\*48) for Generator 2.

Generator 1 uses the multiplicative congruential method, with

$$S(I+1) = ( 16807.0 * S(I) ) \text{ mod } (2.0**31-1)$$

and

$$X(I+1) = S(I+1) / (2.0**31-1)$$

Generator 1 cycles after 2\*\*31-2 random numbers.

Generator 2 also uses the multiplicative congruential method, with

$$S(I+1) = ( 44,485,709,377,909.0 * S(I) ) \\ \text{ mod } (2.0**48)$$

and

$$X(I+1) = S(I+1) / (2.0**48)$$

Generator 2 cycles after (2\*\*48) random numbers. Although generator 1 is the default (for reasons of backwards compatibility) the use of generator 2 is recommended for new programs since it typically runs faster than generator 1 and has a longer period.

If no argument is present, the seed of the current generator is set to the default value 1d0.

End of IBM Extension

## Examples

```
CALL RANDOM_SEED
  ! Current generator sets its seed to 1d0
CALL RANDOM_SEED (SIZE = K)
  ! Sets K = 64 / BIT_SIZE( 0 )
CALL RANDOM_SEED (PUT = SEED (1 : K))
  ! Transfer seed to current generator
CALL RANDOM_SEED (GET = OLD (1 : K))
  ! Transfer seed from current generator
```

---

## RANGE(X)

### Purpose

Returns the decimal exponent range in the model representing integer or real numbers with the same kind type parameter as the argument.

## Class

Inquiry function

## Argument type and attributes

X must be of type integer, real, or complex. It may be scalar or array valued.

## Result type and attributes

Default integer scalar.

## Result value

1. For an integer argument, the result is:  
`INT( LOG10( HUGE(X) ) )`
2. For a real or complex argument, the result is:  
`INT( MIN( LOG10( HUGE(X) ), -LOG10( TINY(X) ) ) )`

### IBM Extension

Thus:

Type	RANGE
integer(1)	2
integer(2)	4
integer(4)	9
integer(8)	18
real(4) , complex(4)	37
real(8) , complex(8)	307
real(16) , complex(16)	291

### End of IBM Extension

## Examples

### IBM Extension

X is of type real(4):  
HUGE(X) = 0.34E+39  
TINY(X) = 0.11E-37  
RANGE(X) = 37

### End of IBM Extension

See "Data representation models" on page 531.

---

## REAL(A, KIND)

### Purpose

Convert to real type.

### Class

Elemental function

## Argument type and attributes

**A** must be of type integer, real, complex, or a *boz-literal* constant.

**KIND (optional)**

must be a scalar integer initialization expression.

## Result type and attributes

- Real.
- Case (i): If A is of type integer or real and **KIND** is present, the kind type parameter is that specified by **KIND**. If A is of type integer or real and **KIND** is not present, the kind type parameter is the kind type parameter of the default real type.
- Case (ii): If A is of type complex and **KIND** is present, the kind type parameter is that specified by **KIND**. If A is of type complex and **KIND** is not present, the kind type parameter is the kind type parameter of A.
- Case (iii): If A is a *boz-literal* constant and **KIND** is present, the kind type parameter is that specified by **KIND**. If A is a *boz-literal* constant and **KIND** is not present, the kind type parameter is that of default real type.

## Result value

- Case (i): If A is of type integer or real, the result is equal to a kind-dependent approximation to A.
- Case (ii): If A is of type complex, the result is equal to a kind-dependent approximation to the real part of A.
- Case (iii): If A is a *boz-literal* constant, the value of the result is equal to the value that a variable of the same type and kind type parameters as the result would have if its value were the bit pattern specified by the *boz-literal* constant.

## Examples

**REAL** (-3) has the value -3.0. **REAL** ((3.2, 2.1)) has the value 3.2.

Specific Name	Argument Type	Result Type	Pass As Arg?
REAL	default integer	default real	no
FLOAT	any integer <b>1</b>	default real	no
SNGL	double precision real	default real	no
SNGLQ	REAL(16)	default real	no <b>2</b>
DREAL	double complex	double precision real	no <b>2</b>
QREAL	COMPLEX(16)	REAL(16)	no <b>2</b>

**Notes:**

1. IBM Extension: the ability to specify a nondefault integer argument.
2. IBM Extension: the inability to pass the name as an argument.

---

## REPEAT(String, NCOPIES)

### Purpose

Concatenate several copies of a string.

## Class

Transformational function

## Argument type and attributes

### STRING

must be scalar and of type character.

### NCOPIES

must be scalar and of type integer. Its value must not be negative.

## Result type and attributes

Character scalar with a length equal to  $NCOPIES * LENGTH(STRING)$ , with the same kind type parameter as STRING.

## Result value

The value of the result is the concatenation of NCOPIES copies of STRING.

## Examples

`REPEAT ('H', 2)` has the value 'HH'. `REPEAT ('XYZ', 0)` has the value of a zero-length string.

---

## RESHAPE(SOURCE, SHAPE, PAD, ORDER)

## Purpose

Constructs an array of a specified shape from the elements of a given array.

## Class

Transformational function

## Argument type and attributes

### SOURCE

is an array of any type, which supplies the elements for the result array.

### SHAPE

defines the shape of the result array. It is an integer array of up to 20 elements, with rank one and of a constant size. All elements are either positive integers or zero.

### PAD (optional)

is used to fill in extra values if SOURCE is reshaped into a larger array. It is an array of the same data type and type parameter as SOURCE. If it is absent or is a zero-sized array, you can only make SOURCE into another array of the same size or smaller.

### ORDER (optional)

is an integer array of rank one with a constant size. Its elements must be a permutation of (1, 2, ..., SIZE(SHAPE)). You can use it to insert elements in the result in an order of dimensions other than the normal (1, 2, ..., rank(RESULT)).

## Result value

The result is an array with shape SHAPE. It has the same data type and type parameter as SOURCE.

The array elements of SOURCE are placed into the result in the order of dimensions as specified by ORDER, or in the usual order for array elements if ORDER is not specified.

The array elements of SOURCE are followed by the array elements of PAD in array element order, and followed by additional copies of PAD until all of the elements of the result are set.

## Examples

```
! Turn a rank-1 array into a 3x4 array of the
! same size.
RES= RESHAPE( (/A,B,C,D,E,F,G,H,I,J,K,L/), (/3,4/)
! The result is | A D G J |
!               | B E H K |
!               | C F I L |

! Turn a rank-1 array into a larger 3x5 array.
! Keep repeating -1 and -2 values for any
! elements not filled by the source array.
! Fill the rows first, then the columns.
RES= RESHAPE( (/1,2,3,4,5,6/), (/3,5/), &
(/-1,-2/), (/2,1/))
! The result is | 1 2 3 4 5 |
!               | 6 -1 -2 -1 -2 |
!               | -1 -2 -1 -2 -1 |
```

## Related information

“SHAPE(SOURCE, KIND) ” on page 648.

---

## RRSPACING(X)

### Purpose

Returns the reciprocal of the relative spacing of the model numbers near the argument value.

### Class

Elemental function

### Argument type and attributes

X must be of type real.

### Result type and attributes

Same as X.

### Result value

The result is:

$\text{ABS}(\text{FRACTION}(X)) * \text{FLOAT}(\text{RADIX}(X))^{\text{DIGITS}(X)}$

## Examples

IBM Extension

RRSPACING (-3.0) = 0.75 \* 2<sup>24</sup>. See "Real data model" on page 533.

End of IBM Extension

---

## RSHIFT(I, SHIFT)

IBM Extension

### Purpose

Performs a logical shift to the right.

### Class

Elemental function

### Argument type and attributes

I must be of type integer.  
SHIFT must be of type integer. It must be non-negative and less than or equal to BIT\_SIZE(I).

### Result type and attributes

Same as I.

### Result value

- The result has the value obtained by shifting the bits of I by SHIFT positions to the right.
- Vacated bits are filled with the sign bit.
- The bits are numbered 0 to BIT\_SIZE(I)-1, from right to left.

## Examples

RSHIFT (3, 1) has the result 1.

RSHIFT (3, 2) has the result 0.

Specific Name	Argument Type	Result Type	Pass As Arg?
RSHIFT	any integer	same as argument	yes

End of IBM Extension

---

## SAME\_TYPE\_AS(A,B)

Fortran 2003

### Purpose

Inquires whether the dynamic type of A is the same as the dynamic type of B.

## Class

Inquiry function

## Argument type and attributes

- A** must be an object of extensible type. If it is a pointer, it must not have an undefined association status.
- B** must be an object of extensible type. If it is a pointer, it must not have an undefined association status.

## Result type and attributes

Default logical scalar

## Result value

The result is true if the dynamic type of A is the same as the dynamic type of B.

End of Fortran 2003

---

## SCALE(X,I)

### Purpose

Returns the scaled value:  $X * 2.0^I$

### Class

Elemental function

### Argument type and attributes

- X** must be of type real.
- I** must be of type integer.

### Result type and attributes

Same as X.

### Result value

IBM Extension

The result is determined from the following:

$$X * 2.0^I$$

$$\text{SCALE}(X, I) = X * (2.0^I)$$

End of IBM Extension

## Examples

IBM Extension

`SCALE (4.0, 3) = 4.0 * (23) = 32.0`. See “Real data model” on page 533.

End of IBM Extension

---

## SCAN(String, SET, BACK, KIND)

### Purpose

Scan a string for any one of the characters in a set of characters.

### Class

Elemental function

### Argument type and attributes

**STRING**

must be of type character.

**SET** must be of type character with the same kind type parameter as **STRING**.

**BACK (optional)**

must be of type logical.

**KIND (optional)**

must be a scalar integer initialization expression.

### Result type and attributes

If **KIND** is present, the result is of type integer with a kind parameter value equal to that specified by **KIND**; otherwise, the result is of type default integer.

### Result value

- Case (i): If **BACK** is absent or is present with the value `.FALSE.` and if **STRING** contains at least one character that is in **SET**, the value of the result is the position of the leftmost character of **STRING** that is in **SET**.
- Case (ii): If **BACK** is present with the value `.TRUE.` and if **STRING** contains at least one character that is in **SET**, the value of the result is the position of the rightmost character of **STRING** that is in **SET**.
- Case (iii): The value of the result is zero if no character of **STRING** is in **SET** or if the length of **STRING** or **SET** is zero.

### Examples

- Case (i): `SCAN ('FORTRAN', 'TR')` has the value 3.
- Case (ii): `SCAN ('FORTRAN', 'TR', BACK = .TRUE.)` has the value 5.
- Case (iii): `SCAN ('FORTRAN', 'BCD')` has the value 0.



---

## SELECTED\_CHAR\_KIND(NAME)

Fortran 2003

### Purpose

Returns a value of the kind type parameter of a character data type.

### Class

Transformational function

### Argument type and attributes

NAME

must be a scalar of type default character.

### Result type and attributes

Default integer scalar.

### Result value

- If you specify NAME as ASCII, **SELECTED\_CHAR\_KIND** returns the kind type parameter of the ASCII character type.
- If you specify NAME as DEFAULT, **SELECTED\_CHAR\_KIND** returns the kind type parameter of the default character type
- Otherwise, **SELECTED\_CHAR\_KIND** returns -1.

### Related information

Kind type parameters supported by XL Fortran are defined in “Type declaration: type parameters and specifiers” on page 16.

End of Fortran 2003

---

## SELECTED\_INT\_KIND(R)

### Purpose

Returns a value of the kind type parameter of an integer data type that represents all integer values  $n$  with  $-10^R < n < 10^R$ .

### Class

Transformational function

### Argument type and attributes

R must be a scalar of type integer.

### Result type and attributes

Default integer scalar.

## Result value

- The result has a value equal to the value of the kind type parameter of an integer data type that represents all values  $n$  in the range values  $n$  with  $-10^R < n < 10^R$ , or if no such kind type parameter is available, the result is -1.
- If more than one kind type parameter meets the criteria, the value returned is the one with the smallest decimal exponent range.

## Examples

<b>IBM Extension</b>
<code>SELECTED_INT_KIND</code> (9) has the value 4, signifying that an INTEGER with kind type 4 can represent all values from $10^{-9}$ to $10^9$ .
<b>End of IBM Extension</b>

## Related information

Kind type parameters supported by XL Fortran are defined in “Type declaration: type parameters and specifiers” on page 16.

---

## SELECTED\_REAL\_KIND(P, R)

### Purpose

Returns a value of the kind type parameter of a real data type with decimal precision of at least P digits and a decimal exponent range of at least R.

### Class

Transformational function

### Argument type and attributes

**P (optional)**  
must be scalar and of type integer.

**R (optional)**  
must be scalar and of type integer.

### Result type and attributes

Default integer scalar.

### Result value

- The result has a value equal to a value of the kind type parameter of a real data type with decimal precision, as returned by the function `PRECISION`, of at least P digits and a decimal exponent range, as returned by the function `RANGE`, of at least R, or if no such kind type parameter is available,
  - If the precision is not available, the result is -1.
  - If the exponent range is not available, the result is -2.
  - If neither is available, the result is -3.
- If more than one kind type parameter value meets the criteria, the value returned is the one with the smallest decimal precision, unless there are several such values, in which case the smallest of these kind values is returned.

## Examples

IBM Extension

SELECTED\_REAL\_KIND (6, 70) has the value 8.

End of IBM Extension

## Related information

Kind type parameters supported by XL Fortran are defined in “Type declaration: type parameters and specifiers” on page 16.

---

## SET\_EXPONENT(X,I)

### Purpose

Returns the number whose fractional part is the fractional part of the model representation of X, and whose exponent part is I.

### Class

Elemental function

### Argument type and attributes

X        must be of type real.  
I        must be of type integer.

### Result type and attributes

Same as X.

### Result value

IBM Extension

- If X = 0 the result is zero.
- Otherwise, the result is:  
$$\text{FRACTION}(X) * 2.0^I$$

End of IBM Extension

## Examples

IBM Extension

SET\_EXPONENT (10.5, 1) = 0.65625 \* 2.0<sup>1</sup> = 1.3125

See “Real data model” on page 533.

End of IBM Extension

---

## SHAPE(SOURCE, KIND)

### Purpose

Returns the shape of an array or scalar.

### Class

Inquiry function

### Argument type and attributes

**SOURCE** is an array or scalar of any data type. It must not be a disassociated pointer, allocatable object that is not allocated, or assumed-size array.

**KIND (optional)** must be a scalar integer initialization expression.

### Result type and attributes

The result is an array of rank one whose size is `RANK(SOURCE)`. If **KIND** is present, the result is of type integer with a kind parameter value equal to that specified by **KIND**; otherwise, the result is of type default integer.

### Result value

The extent of each dimension in **SOURCE** is returned in the corresponding element of the result array.

### Related information

“`RESHAPE(SOURCE, SHAPE, PAD, ORDER)`” on page 640.

### Examples

```
! A is the array | 7 6 3 1 |
!               | 2 4 0 9 |
!               | 5 7 6 8 |
!
      RES = SHAPE( A )
! The result is | 3 4 | because A is a rank-2 array
! with 3 elements in each column and 4 elements in
! each row.
```

---

## SIGN(A, B)

### Purpose

Returns the absolute value of A times the sign of B. If A is non-zero, you can use the result to determine whether B is negative or non-negative, as the sign of the result is the same as the sign of B.

Note that if you have declared B as **REAL(4)** or **REAL(8)**, and B has a negative zero value, the sign of the result depends on whether you have specified the `-qxlf90=signedzero` compiler option.

### Class

Elemental function

## Argument type and attributes

- A must be of type integer or real.
- B must be of the same type and kind type parameter as A.

## Result type and attributes

Same as A.

## Result value

The result is  $sgn * |A|$ , where:

- $sgn = -1$ , if either of the following is true:
  - $B < 0$

### IBM Extension

- B is a **REAL(4)** or **REAL(8)** number with a value of negative 0, and you have specified the **-qxlf90=signedzero** option

### End of IBM Extension

- $sgn = 1$ , otherwise.

### Fortran 95

Fortran 95 allows a processor to distinguish between a positive and a negative real zero, whereas Fortran 90 did not. Using the **-qxlf90=signedzero** option allows you to specify the Fortran 95 behavior (except in the case of **REAL(16)** numbers), which is consistent with the IEEE standard for binary floating-point arithmetic. **-qxlf90=signedzero** is the default for the **xlF95**, **xlF95\_r**, **xlF95\_r7**, **f95**, **xlF2003**, **xlF2003\_r**, and **f2003** invocation commands.

### End of Fortran 95

## Examples

**SIGN** (-3.0, 2.0) has the value 3.0.

Specific Name	Argument Type	Result Type	Pass As Arg?
SIGN	default real	default real	yes
ISIGN	any integer <b>1</b>	same as argument	yes
DSIGN	double precision real	double precision real	yes
QSIGN	REAL(16)	REAL(16)	yes <b>2</b>

### Notes:

1. IBM Extension: the ability to specify a nondefault integer argument.
2. IBM Extension: the ability to pass the name as an argument.

## Related information

See the **-qxlf90** option in the *XL Fortran Compiler Reference*.

---

## SIGNAL(I, PROC)

IBM Extension

### Purpose

The SIGNAL procedure allows a program to specify a procedure to be invoked upon receipt of a specific operating-system signal.

### Class

Subroutine

### Argument type and attributes

- I** is an integer that specifies the value of the signal to be acted upon. It is an **INTENT(IN)** argument. Available signal values are defined in the C include file **signal.h**; a subset of signal values is defined in the Fortran include file **fexcp.h**.
- PROC** specifies the user-defined procedure to be invoked when the process receives the specified signal specified by argument I. It is an **INTENT(IN)** argument.

### Examples

```
INCLUDE 'fexcp.h'
INTEGER  SIGUSR1
EXTERNAL USRINT
! Set exception handler to produce the traceback code.
! The SIGTRAP is defined in the include file fexcp.h.
! xl_trce is a procedure in the XL Fortran
! run-time library. It generates the traceback code.
CALL SIGNAL(SIGTRAP, XL_TRCE)
...
! Use user-defined procedure USRINT to handle the signal
! SIGUSR1.
CALL SIGNAL(SIGUSR1, USRINT)
...
```

### Related information

See the **signal** subroutine in the *AIX Technical Reference: Base Operating System and Extensions Volume 2* for details about the underlying implementation.

The **-qsigtrap** option in the *XL Fortran Compiler Reference* allows you to set a handler for **SIGTRAP** signals through a compiler option.

End of IBM Extension

---

## SIN(X)

### Purpose

Sine function.

### Class

Elemental function

## Argument type and attributes

X must be of type real or complex. If X is real, it is regarded as a value in radians. If X is complex, its real and imaginary parts are regarded as values in radians.

## Result type and attributes

Same as X.

## Result value

It approximates  $\sin(X)$ .

## Examples

SIN (1.0) has the value 0.84147098 (approximately).

Specific Name	Argument Type	Result Type	Pass As Arg?
SIN	default real	default real	yes
DSIN	double precision real	double precision real	yes
QSIN	REAL(16)	REAL(16)	yes <b>1</b>
CSIN <b>2a</b>	default complex	default complex	yes
CDSIN <b>2b</b>	double complex	double complex	yes <b>1</b>
ZSIN <b>2b</b>	double complex	double complex	yes <b>1</b>
CQSIN <b>2b</b>	COMPLEX(16)	COMPLEX(16)	yes <b>1</b>

### Notes:

1. IBM Extension: the ability to pass the name as an argument.
2. Given that X is a complex number in the form  $a + bi$ , where  $i = (-1)^{\frac{1}{2}}$ :
  - a.  $\text{abs}(b)$  must be less than or equal to 88.7228; a is any real value.
  - b.  $\text{abs}(b)$  must be less than or equal to 709.7827; a is any real value.

---

## SIND(X)

IBM Extension

## Purpose

Sine function. Argument in degrees.

## Class

Elemental function

## Argument type and attributes

X must be of type real.

## Result type and attributes

Same as X.

## Result value

- It approximates  $\sin(X)$ , where X has a value in degrees.

## Examples

SIND (90.0) has the value 1.0.

Specific Name	Argument Type	Result Type	Pass As Arg?
SIND	default real	default real	yes
DSIND	double precision real	double precision real	yes
QSIND	REAL(16)	REAL(16)	yes

End of IBM Extension

---

## SINH(X)

### Purpose

Hyperbolic sine function.

### Class

Elemental function

### Argument type and attributes

X must be of type real.

### Result type and attributes

Same as X.

### Result value

The result has a value equal to  $\sinh(x)$ .

## Examples

SINH (1.0) has the value 1.1752012 (approximately).

Specific Name	Argument Type	Result Type	Pass As Arg?
SINH <b>1</b>	default real	default real	yes
DSINH <b>2</b>	double precision real	double precision real	yes
QSINH <b>2</b> <b>3</b>	REAL(16)	REAL(16)	yes

#### Notes:

1.  $\text{abs}(X)$  must be less than or equal to 89.4159.
2.  $\text{abs}(X)$  must be less than or equal to 709.7827.
3. IBM Extension.

---

## SIZE(ARRAY, DIM, KIND)

### Purpose

Returns the extent of an array along a specified dimension or the total number of elements in the array.

### Class

Inquiry function



## Argument type and attributes

### ARRAY

is an array of any data type. It must not be a scalar, disassociated pointer, or allocatable array that is not allocated. It can be an assumed-size array if DIM is present and has a value that is less than the rank of ARRAY.

### DIM (optional)

is an integer scalar in the range  $1 \leq \text{DIM} \leq \text{rank}(\text{ARRAY})$ .

### KIND (optional)

must be a scalar integer initialization expression.

## Result type and attributes

The result is a scalar integer. If **KIND** is present, the kind of the result is that specified by the value of **KIND**; otherwise, the result is of type default integer.

## Result value

The result equals the extent of ARRAY along dimension DIM; or, if DIM is not specified, it is the total number of array elements in ARRAY.

## Examples

```
! A is the array  | 1 -4  7 -10 |
!                | 2  5 -8  11 |
!                | 3  6  9 -12 |
```

```
RES = SIZE( A )
```

```
! The result is 12 because there are 12 elements in A.
```

```
RES = SIZE( A, DIM = 1)
```

```
! The result is 3 because there are 3 rows in A.
```

```
RES = SIZE( A, DIM = 2)
```

```
! The result is 4 because there are 4 columns in A.
```

---

## SIZEOF(A)

---

### IBM Extension

---

### Purpose

Returns the size of an argument in bytes.

### Class

Inquiry function

## Argument type and attributes

**A** can be any data object except an assumed-size array.

**SIZEOF** must not be passed as an argument to a subprogram.

## Result type and attributes

Default integer scalar.

## Result value

The size of the argument in bytes.

The size of a derived object or record structure containing an allocatable or Fortran 90 pointer component includes only the size of the unallocated object or unassociated pointer component, even if the component is currently allocated or associated.

## Examples

The following example assumes that `-qintsize=4`.

```
INTEGER ARRAY(10)
INTEGER*8, PARAMETER :: p = 8
STRUCTURE /STR/
  INTEGER I
  COMPLEX C
END STRUCTURE
RECORD /STR/ R
CHARACTER*10 C
TYPE DTYPE
  INTEGER ARRAY(10)
END TYPE
TYPE (DTYPE) DOBJ
PRINT *, SIZEOF (ARRAY), SIZEOF (ARRAY(3)), SIZEOF (P) ! Array, array
                                                    ! element ref,
                                                    ! named constant

PRINT *, SIZEOF (R), SIZEOF (R.C)                ! record structure
                                                    ! entity, record
                                                    ! structure
                                                    ! component

PRINT *, SIZEOF (C(2:5)), SIZEOF (C)            ! character
                                                    ! substring,
                                                    ! character
                                                    ! variable

PRINT *, SIZEOF (DOBJ), SIZEOF (DOBJ%ARRAY)     ! derived type
                                                    ! object, structure
                                                    ! component
```

The following is sample output generated by the program above:

```
40  4  8
16  8
 4 10
40 40
```

## Related information

See the *XL Fortran Compiler Reference* for details about the `-qintsize` compiler option.

End of IBM Extension

---

## SPACING(X)

### Purpose

Returns the absolute spacing of the model numbers near the argument value.

## Class

Elemental function

## Argument type and attributes

$X$  must be of type real.

## Result type and attributes

Same as  $X$ .

## Result value

If  $X$  is not 0, the result is:

$$2.0^{\text{EXPONENT}(X) - \text{DIGITS}(X)}$$

If  $X$  is 0, the result is the same as that of `TINY(X)`.

## Examples

IBM Extension

`SPACING (3.0) = 2.02 - 24 = 2.0(-22)` See "Real data model" on page 533.

End of IBM Extension

---

## SPREAD(SOURCE, DIM, NCOPIES)

### Purpose

Replicates an array in an additional dimension by making copies of existing elements along that dimension.

### Class

Transformational function

### Argument type and attributes

#### SOURCE

can be an array or scalar. It can have any data type. The rank of `SOURCE` has a maximum value of 19.

**DIM** is an integer scalar in the range  $1 \leq \text{DIM} \leq \text{rank}(\text{SOURCE})+1$ . Unlike most other array intrinsic functions, `SPREAD` requires the `DIM` argument.

#### NCOPIES

is an integer scalar. It becomes the extent of the extra dimension added to the result.

### Result type and attributes

The result is an array of rank  $\text{rank}(\text{SOURCE})+1$  and with the same type and type parameters as source.

## Result value

If `SOURCE` is a scalar, the result is a one-dimensional array with `NCOPIES` elements, each with value `SOURCE`.

If `SOURCE` is an array, the result is an array of rank `rank(SOURCE) + 1`. Along dimension `DIM`, each array element of the result is equal to the corresponding array element in `SOURCE`.

If `NCOPIES` is less than or equal to zero, the result is a zero-sized array.

## Examples

```
! A is the array (/ -4.7, 6.1, 0.3 /)

      RES = SPREAD( A, DIM = 1, NCOPIES = 3 )
! The result is  | -4.7 6.1 0.3 |
!               | -4.7 6.1 0.3 |
!               | -4.7 6.1 0.3 |
! DIM=1 extends each column. Each element in RES(:,1)
! becomes a copy of A(1), each element in RES(:,2) becomes
! a copy of A(2), and so on.

      RES = SPREAD( A, DIM = 2, NCOPIES = 3 )
! The result is  | -4.7 -4.7 -4.7 |
!               |  6.1  6.1  6.1 |
!               |  0.3  0.3  0.3 |
! DIM=2 extends each row. Each element in RES(1,:)
! becomes a copy of A(1), each element in RES(2,:)
! becomes a copy of A(2), and so on.

      RES = SPREAD( A, DIM = 2, NCOPIES = 0 )
! The result is (/ /) (a zero-sized array).
```

---

## SQRT(X)

### Purpose

Square root.

### Class

Elemental function

### Argument type and attributes

`X` must be of type real or complex. Unless `X` is complex, its value must be greater than or equal to zero.

### Result type and attributes

Same as `X`.

### Result value

- It has a value equal to the square root of `X`.

The `-qxlf2003=signdzerointr` option controls whether you get Fortran 2003 behavior. See `-qxlf2003` in the *XL Fortran Compiler Reference*

---

**Fortran 95**

---

---

**End of Fortran 95**

---

- If the result type is complex, its value is the principal value with the real part greater than or equal to zero. If the real part is zero, the imaginary part is greater than or equal to zero.

---

**Fortran 2003**

---

---

**End of Fortran 2003**

---

- If the result type is complex, its value is the principal value with the real part greater than or equal to zero. If the real part of the result is zero, the imaginary part has the same sign as the imaginary part of X.

## Examples

**SQRT** (4.0) has the value 2.0.

Specific Name	Argument Type	Result Type	Pass As Arg?
<b>SQRT</b>	default real	default real	yes
<b>DSQRT</b>	double precision real	double precision real	yes
<b>QSQRT</b>	REAL(16)	REAL(16)	yes <b>1</b>
<b>CSQRT</b> <b>2</b>	default complex	default complex	yes
<b>CDSQRT</b> <b>2</b>	double complex	double complex	yes <b>1</b>
<b>ZSQRT</b> <b>2</b>	COMPLEX(8)	COMPLEX(8)	yes <b>1</b>
<b>CQSQRT</b> <b>2</b>	COMPLEX(16)	COMPLEX(16)	yes <b>1</b>

### Notes:

1. IBM Extension: the ability to pass the name as an argument.
2. Given that X is a complex number in the form  $a + bi$ , where  $i = (-1)^{\frac{1}{2}}$ ,  $\text{abs}(X) + \text{abs}(a)$  must be less than or equal to  $1.797693 * 10^{308}$ .

---

## SRAND(SEED)

---

**IBM Extension**

---

### Purpose

Provides the seed value used by the random number generator function **RAND**. This intrinsic subroutine is not recommended. Use the standards conforming **RANDOM\_NUMBER(HARVEST)** intrinsic subroutine.

### Class

Subroutine

### Argument type and attributes

**SEED** must be scalar. It must be of type **REAL(4)** when used to provide a seed value for the **RAND** function, or of type **INTEGER(4)** when used to provide a seed value for the **IRAND** service and utility function. It is an **INTENT(IN)** argument.

## Examples

The following is an example of a program using the **SRAND** subroutine.

```
CALL SRAND(0.5)
DO I = 1, 5
  R = RAND()
  PRINT *,R
ENDDO
END
```

The following is sample output generated by the above program:

```
0.3984375000
0.4048461914
0.1644897461
0.1281738281E-01
0.2313232422E-01
```

End of IBM Extension

---

## SUM(ARRAY, DIM, MASK) or SUM(ARRAY, MASK)

### Purpose

Calculates the sum of selected elements in an array.

### Class

Transformational function

### Argument type and attributes

**ARRAY** is an array of numeric type, whose elements you want to sum.

**DIM (optional)** is an integer scalar in the range  $1 \leq \text{DIM} \leq \text{rank}(\text{ARRAY})$ .

**MASK (optional)** is a logical expression. If it is an array, it must conform with **ARRAY** in shape. If **MASK** is a scalar, the scalar value applies to all elements in **ARRAY**.

### Result value

If **DIM** is present, the result is an array of rank  $\text{rank}(\text{ARRAY})-1$ , with the same data type and kind type parameter as **ARRAY**. If **DIM** is missing, or if **MASK** has a rank of one, the result is a scalar.

The result is calculated by one of the following methods:

#### Method 1:

If only **ARRAY** is specified, the result equals the sum of all the array elements of **ARRAY**. If **ARRAY** is a zero-sized array, the result equals zero.

#### Method 2:

If **ARRAY** and **MASK** are both specified, the result equals the sum of the array elements of **ARRAY** that have a corresponding array element in **MASK** with a value of **.TRUE.**. If **MASK** has no elements with a value of **.TRUE.**, the result is equal to zero.

### Method 3:

If DIM is also specified, the result value equals the sum of the array elements of ARRAY along dimension DIM that have a corresponding true array element in MASK.

---

#### Fortran 95

---

Because both DIM and MASK are optional, various combinations of arguments are possible. When the **-qintlog** option is specified with two arguments, the second argument refers to one of the following:

- MASK if it is an array of type integer, logical, byte or typeless
- DIM if it is a scalar of type integer, byte or typeless
- MASK if it is a scalar of type logical

---

#### End of Fortran 95

---

## Examples

### Method 1:

```
! Sum all the elements in an array.
RES = SUM( (/2, 3, 4 /) )
! The result is 9 because (2+3+4) = 9
```

### Method 2:

```
! A is the array (/ -3, -7, -5, 2, 3 /)
! Sum all elements that are greater than -5.
RES = SUM( A, MASK = A .GT. -5 )
! The result is 2 because (-3 + 2 + 3) = 2
```

### Method 3:

```
! B is the array | 4 2 3 |
!                | 7 8 5 |

! Sum the elements in each column.
RES = SUM(B, DIM = 1)
! The result is | 11 10 8 | because (4 + 7) = 11
!                                     (2 + 8) = 10
!                                     (3 + 5) = 8

! Sum the elements in each row.
RES = SUM(B, DIM = 2)
! The result is | 9 20 | because (4 + 2 + 3) = 9
!                                     (7 + 8 + 5) = 20

! Sum the elements in each row, considering only
! those elements greater than two.
RES = SUM(B, DIM = 2, MASK = B .GT. 2)
! The result is | 7 20 | because (4 + 3) = 7
!                                     (7 + 8 + 5) = 20
```

---

## SYSTEM(CMD, RESULT)

---

### IBM Extension

---

### Purpose

Passes a command to the operating system for execution. The current process pauses until the command is completed and control is returned from the operating

system. An added, optional argument to the subroutine will allow recovery of any return code information from the operating system.

## Class

Subroutine

## Argument type and attributes

**CMD** must be scalar and of type character, specifying the command to execute and any command-line arguments. It is an **INTENT(IN)** argument.

**RESULT** must be a scalar variable of type **INTEGER(4)**. If the argument is not an **INTEGER(4)** variable, the compiler will generate an **(S)** level error message. It is an optional **INTENT(OUT)** argument. The format of the information returned in **RESULT** is the same as the format returned from the wait system call.

## Examples

```
      INTEGER      ULIMIT
      CHARACTER(32) CMD
      ...
! Check the system ulimit.
      CMD = 'ulimit > ./fort.99'
      CALL SYSTEM(CMD)
      READ(99, *) ULIMIT
      IF (ULIMIT .LT. 2097151) THEN
      ...

      INTEGER RC
      RC=99
      CALL SYSTEM("/bin/test 1 -EQ 2",RC)
      IF (IAND(RC,'ff'z) .EQ. 0) then
        RC = IAND( ISHFT(RC,-8), 'ff'z )
      ELSE
        RC = -1
      ENDIF
```

## Related information

See the **system** subroutine in the *AIX Technical Reference: Base Operating System and Extensions Volume 2* for details about the underlying implementation.

\_\_\_\_\_ End of IBM Extension \_\_\_\_\_

---

## SYSTEM\_CLOCK(COUNT, COUNT\_RATE, COUNT\_MAX)

### Purpose

Returns numeric data from a real-time clock.

### Class

Subroutine

### Argument type and attributes

**COUNT (optional)** is an **INTENT(OUT)** argument that must be scalar and of type integer. The initial value of **COUNT** depends on the current value of the processor clock



in a range from 0 to COUNT\_MAX. COUNT increments by one for each clock count until it reaches the value of COUNT\_MAX. At the next clock count after COUNT\_MAX, the value of COUNT resets to zero.

**COUNT\_RATE (optional)**

is an **INTENT(OUT)** argument that must be scalar and of type integer or type real. When using the default centisecond resolution, COUNT\_RATE refers to the number of processor clock counts per second or to zero if there is no clock.

IBM Extension

If you specify a microsecond resolution using **-qsclk=micro**, the value of COUNT\_RATE is 1 000 000 clock counts per second.

End of IBM Extension

**COUNT\_MAX (optional)**

is an **INTENT(OUT)** argument that must be scalar and of type integer. When using the default centisecond resolution, COUNT\_MAX is the maximum number of clock counts for a given processor clock.

IBM Extension

If you specify a microsecond resolution using **-qsclk=micro** and COUNT\_MAX is of type **INTEGER(4)**, the value of COUNT\_MAX is 1 799 999 999 clock counts, or about 30 minutes.

If you specify a microsecond resolution using **-qsclk=micro** and COUNT\_MAX is of type **INTEGER(8)**, the value of COUNT\_MAX is 86 399 999 999 clock counts, or about 24 hours.

End of IBM Extension

## Examples

IBM Extension

In the following example, the clock is a 24-hour clock. After the call to SYSTEM\_CLOCK, the COUNT contains the day time expressed in clock ticks per second. The number of ticks per second is available in the COUNT\_RATE. The COUNT\_RATE value is implementation dependent.

```
INTEGER, DIMENSION(8) :: IV
TIME_SYNC: DO
CALL DATE_AND_TIME (VALUES=IV)
IHR = IV(5)
IMIN = IV(6)
ISEC = IV(7)
CALL SYSTEM_CLOCK(COUNT=IC, COUNT_RATE=IR, COUNT_MAX=IM)
CALL DATE_AND_TIME (VALUES=IV)

IF ((IHR == IV(5)) .AND. (IMIN == IV(6)) .AND. &
    (ISEC == IV(7))) EXIT TIME_SYNC
```

```

END DO TIME_SYNC

IDAY_SEC = 3600*IHR + IMIN*60 + ISEC
IDAY_TICKS = IDAY_SEC * IR

IF (IDAY_TICKS /= IC) THEN
  STOP 'clock error'
ENDIF
END

```

End of IBM Extension

## Related information

See the `-qsclock` compiler option in the *XL Fortran Compiler Reference* for more information on specifying system clock resolution.

---

## TAN(X)

### Purpose

Tangent function.

### Class

Elemental function

### Argument type and attributes

X must be of type real.

### Result type and attributes

Same as X.

### Result value

The result approximates  $\tan(X)$ , where X has a value in radians.

### Examples

TAN (1.0) has the value 1.5574077 (approximately).

Specific Name	Argument Type	Result Type	Pass As Arg?
TAN	default real	default real	yes
DTAN	double precision real	double precision real	yes
QTAN	REAL(16)	REAL(16)	yes <b>1</b>

#### Notes:

1. IBM Extension: the ability to pass the name as an argument.

---

## TAND(X)

IBM Extension

### Purpose

Tangent function. Argument in degrees.

### Class

Elemental function

### Argument type and attributes

X must be of type real.

### Result type and attributes

Same as X.

### Result value

The result approximates  $\tan(X)$ , where X has a value in degrees.

### Examples

TAND (45.0) has the value 1.0.

Specific Name	Argument Type	Result Type	Pass As Arg?
TAND	default real	default real	yes
DTAND	double precision real	double precision real	yes
QTAND	REAL(16)	REAL(16)	yes

End of IBM Extension

---

## TANH(X)

### Purpose

Hyperbolic tangent function.

### Class

Elemental function

### Argument type and attributes

X must be of type real.

### Result type and attributes

Same as X.

### Result value

The result has a value equal to  $\tanh(X)$ .

## Examples

TANH (1.0) has the value 0.76159416 (approximately).

Specific Name	Argument Type	Result Type	Pass As Arg?
TANH	default real	default real	yes
DTANH	double precision real	double precision real	yes
QTANH	REAL(16)	REAL(16)	yes <b>1</b>

### Notes:

1. IBM Extension: the ability to pass the name as an argument.

---

## TINY(X)

### Purpose

Returns the smallest positive number in the model representing numbers of the same type and kind type parameter as the argument.

### Class

Inquiry function

### Argument type and attributes

X must be of type real. It may be a scalar or an array.

### Result type and attributes

Scalar with the same type and kind type parameter as X.

### Result value

IBM Extension

The result is:

$2.0^{(\text{MINEXPONENT}(X)-1)}$  for real X

End of IBM Extension

### Examples

IBM Extension

TINY (X) = float(2)<sup>(-126)</sup> = 1.17549351e-38. See "Real data model" on page 533.

End of IBM Extension

---

## TRANSFER(SOURCE, MOLD, SIZE)

### Purpose

Returns a result with a physical representation identical to that of SOURCE but interpreted with the type and type parameters of MOLD.

It performs a low-level conversion between types without any sign extension, rounding, blank padding, or other alteration that may occur using other methods of conversion.

## Class

Transformational function

## Argument type and attributes

**SOURCE** is the data entity whose bitwise value you want to transfer to a different type. It may be of any type, and may be a scalar or an array.

**MOLD** is a data entity that has the type characteristics you want for the result. If **MOLD** is a variable, the value does not need to be defined. It may be of any type, and may be a scalar or an array. Its value is not used, only its type characteristics.

**SIZE (optional)** is the number of elements for the output result. It must be a scalar integer. The corresponding actual argument must not be an optional dummy argument.

## Result type and attributes

The same type and type parameters as **MOLD**.

If **MOLD** is a scalar and **SIZE** is absent, the result is a scalar.

If **MOLD** is array valued and **SIZE** is absent, the result is array valued and of rank one, with the smallest size that is physically large enough to hold **SOURCE**.

If **SIZE** is present, the result is array valued of rank one and size **SIZE**.

## Result value

The physical representation of the result is the same as **SOURCE**, truncated if the result is smaller or with an undefined trailing portion if the result is larger.

Because the physical representation is unchanged, it is possible to undo the results of **TRANSFER** as long as the result is not truncated:

```
REAL(4) X /3.141/  
DOUBLE PRECISION I, J(6) /1,2,3,4,5,6/
```

```
! Because x is transferred to a larger representation  
! and then back, its value is unchanged.  
X = TRANSFER( TRANSFER( X, I ), X )
```

```
! j is transferred into a real(4) array large enough to  
! hold all its elements, then back into an array of  
! its original size, so its value is unchanged too.  
J = TRANSFER( TRANSFER( J, X ), J, SIZE=SIZE(J) )
```

## Examples

```
▶ IBM TRANSFER (1082130432, 0.0) is 4.0. IBM ◀
```

**TRANSFER** ((/1.1,2.2,3.3/), (/ (0.0,0.0) /)) is a complex rank-one array of length two whose first element has the value (1.1, 2.2) and whose second element has a real part with the value 3.3. The imaginary part of the second element is undefined.

**TRANSFER** ((/1.1,2.2,3.3/), (/ (0.0,0.0) /), 1) has the value (/ (1.1,2.2) /).

---

## TRANSPOSE(MATRIX)

### Purpose

Transposes a two-dimensional array, turning each column into a row and each row into a column.

### Class

Transformational function

### Argument type and attributes

**MATRIX** is an array of any data type, with a rank of two.

### Result value

The result is a two-dimensional array of the same data type and type parameter as **MATRIX**.

The shape of the result is (n,m) where the shape of **MATRIX** is (m,n). For example, if the shape of **MATRIX** is (2,3), the shape of the result is (3,2).

Each element (i,j) in the result has the value **MATRIX** (j,i) for i in the range 1-n and j in the range 1-m.

### Result type and attributes

A two-dimensional array of the same data type as **MATRIX**.

### Examples

```
! A is the array | 0 -5 8 -7 |
!               | 2 4 -1 1 |
!               | 7 5 6 -6 |
! Transpose the columns and rows of A.
!               RES = TRANSPOSE( A )
! The result is | 0 2 7 |
!               | -5 4 5 |
!               | 8 -1 6 |
!               | -7 1 -6 |
```

---

## TRIM(STRING)

### Purpose

Returns the argument with trailing blank characters removed.

### Class

Transformational function

## Argument type and attributes

**STRING** must be of type character and must be a scalar.

## Result type and attributes

Character with the same kind type parameter value as **STRING** and with a length that is the length of **STRING** less the number of trailing blanks in **STRING**.

## Result value

- The value of the result is the same as **STRING**, except trailing blanks are removed.
- If **STRING** contains no nonblank characters, the result has zero length.

## Examples

**TRIM** ('bAbBbb') has the value 'bAbB'.

---

## UBOUND(ARRAY, DIM, KIND)

### Purpose

Returns the upper bounds of each dimension in an array, or the upper bound of a specified dimension.

### Class

Inquiry function

## Argument type and attributes

**ARRAY** is the array whose upper bounds you want to determine. Its bounds must be defined: that is, it must not be a disassociated pointer or an allocatable array that is not allocated, and if its size is assumed, you can only examine one dimension. If **ARRAY** is an assumed-size array, **DIM** shall be present with a value less than the rank of **ARRAY**.

**DIM (optional)** is an integer scalar in the range  $1 \leq \mathbf{DIM} \leq \text{rank}(\mathbf{ARRAY})$ . The corresponding actual argument must not be an optional dummy argument.

**KIND (optional)** must be a scalar integer initialization expression.

## Result type and attributes

If **KIND** is present, the result is of type integer with a kind parameter value equal to that specified by **KIND**; otherwise, the result is of type default integer.

If **DIM** is present, the result is a scalar. If it is not present, the result is a one-dimensional array with one element for each dimension in **ARRAY**.

## Result value

Each element in the result corresponds to a dimension of **ARRAY**. If **ARRAY** is a whole array or array structure component, these values are equal to the upper bounds. If **ARRAY** is an array section or expression that is not a whole array or

array structure component, the values represent the number of elements in each dimension, which may be different than the declared upper bounds of the original array. If a dimension is zero-sized, the corresponding element in the result is zero, regardless of the value of the upper bound.

## Examples

```
! This array illustrates the way UBOUND works with
! different ranges for dimensions.
REAL A(1:10, -4:5, 4:-5)

RES=UBOUND( A )
! The result is (/ 10, 5, 0 /).

RES=UBOUND( A(:, :, :) )
! The result is (/ 10, 10, 0 /) because the argument
! is an array section.

RES=UBOUND( A(4:10, -4:1, :) )
! The result is (/ 7, 6, 0 /), because for an array section,
! it is the number of elements in the corresponding dimensions.
```

---

## UNPACK(VECTOR, MASK, FIELD)

### Purpose

Takes some or all elements from a one-dimensional array and rearranges them into another, possibly larger, array.

### Class

Transformational function

### Argument type and attributes

<b>VECTOR</b>	is a one-dimensional array of any data type. There must be at least as many elements in VECTOR as there are .TRUE. values in MASK.
<b>MASK</b>	is a logical array that determines where the elements of VECTOR are placed when they are unpacked.
<b>FIELD</b>	must have the same shape as the mask argument, and the same data type and type parameter as VECTOR. Its elements are inserted into the result array wherever the corresponding MASK element has the value .FALSE..

### Result value

The elements of the result are filled in array-element order: if the corresponding element in MASK is .TRUE., the result element is filled by the next element of VECTOR; otherwise, it is filled by the corresponding element of FIELD.

### Result type and attributes

An array with the same shape as MASK and the same data type as VECTOR.

### Examples

```
! VECTOR is the array (/ 5, 6, 7, 8 /),
! MASK is | F T T |, FIELD is | -1 -4 -7 |
!         | T F F |         | -2 -5 -8 |
```



```

!          | F F T |          | -3 -6 -9 |

! Turn the one-dimensional vector into a two-dimensional
! array. The elements of VECTOR are placed into the .TRUE.
! positions in MASK, and the remaining elements are
! made up of negative values from FIELD.
      RES = UNPACK( VECTOR, MASK, FIELD )
! The result is | -1  6  7 |
!              |  5 -5 -8 |
!              | -3 -6  8 |

! Do the same transformation, but using all zeros for the
! replacement values of FIELD.
      RES = UNPACK( VECTOR, MASK, FIELD = 0 )
! The result is |  0  6  7 |
!              |  5  0  0 |
!              |  0  0  8 |

```

---

## VERIFY(String, SET, BACK, KIND)

### Purpose

Verify that a set of characters contains all the characters in a string by identifying the position of the first character in a string of characters that does not appear in a given set of characters.

### Class

Elemental function

### Argument type and attributes

**STRING**        must be of type character.

**SET**            must be of type character with the same kind type parameter as **STRING**.

**BACK (optional)**  
                 must be of type logical.

**KIND (optional)**  
                 must be a scalar integer initialization expression.

### Result type and attributes

If **KIND** is present, the result is of type integer with a kind parameter value equal to that specified by **KIND**; otherwise, the result is of type default integer.

### Result value

- Case (i): If **BACK** is absent or present with the value **.FALSE.** and if **STRING** contains at least one character that is not in **SET**, the value of the result is the position of the leftmost character of **STRING** that is not in **SET**.
- Case (ii): If **BACK** is present with the value **.TRUE.** and if **STRING** contains at least one character that is not in **SET**, the value of the result is the position of the rightmost character of **STRING** that is not in **SET**.
- Case (iii): The value of the result is zero if each character in **STRING** is in **SET** or if **STRING** has zero length.

## Examples

- Case (i): `VERIFY ('ABBA', 'A')` has the value 2.
- Case (ii): `VERIFY ('ABBA', 'A', BACK = .TRUE.)` has the value 3.
- Case (iii): `VERIFY ('ABBA', 'AB')` has the value 0.

---

## Chapter 15. Hardware-specific intrinsic procedures

---

### IBM Extension

---

This section provides an alphabetical reference to the hardware-specific intrinsic functions. Many of these intrinsics provide access to hardware instructions that may not strictly conform to all IEEE floating-point semantic rules depending on their usage. You should exercise caution if strict IEEE floating-point conformance is important to your application. Unless otherwise noted, a directive will function on any supported hardware.

---

### F<sub>CFI</sub>(*I*)

#### Purpose

Floating-point Conversion from Integer

Converts an integer value in a floating-point variable into a floating-point value.

This intrinsic is valid on any 64-bit PowerPC architecture.

#### Class

Function

#### Argument type and attributes

*I* must be of type REAL(8).

#### Result type and attributes

Same as *I*.

#### Result value

The double-precision floating-point value of *I*.

#### Examples

```
...  
REAL*8 :: R8, RES  
INTEGER*8 :: I8  
EQUIVALENCE(R8, I8)  
  
I8 = 89  
RES = FCFI(R8) ! RES = 89.0  
...
```

---

### F<sub>CTID</sub>(*X*)

#### Purpose

Floating-point Convert to Integer

Converts a floating-point operand into a 64-bit, signed fixed-point integer using the current rounding mode.

This intrinsic is valid on any 64-bit PowerPC architecture.

## Class

Function

## Argument type and attributes

X must be of type REAL(8).

## Result type and attributes

Same as X.

## Result value

The result is a fixed-point integer, inside a floating point result.

---

## FCTIDZ(X)

### Purpose

Floating-point Convert to Integer Round to Zero

Converts a floating-point operand into a 64-bit signed fixed-point integer and rounds to zero.

This intrinsic is valid on any 64-bit PowerPC architecture.

### Class

Function

### Argument type and attributes

X must be of type REAL(8).

### Result type and attributes

Same as X.

### Result value

The result is a fixed-point integer, inside a floating-point result, rounded to zero.

---

## FCTIW(X)

### Purpose

Floating-point Convert to Integer

Converts a floating-point operand into a 32-bit, signed fixed-point integer using the current rounding mode.

### Class

Function

## Argument type and attributes

*X* must be of type REAL(8).

## Result type and attributes

Same as *X*.

## Result value

The result is a fixed-point integer, inside a floating point result.

---

## FCTIWZ(*X*)

### Purpose

Floating-point Convert to Integer Round to Zero

Converts a floating-point operand into a 32-bit signed fixed-point integer and rounds to zero.

### Class

Function

## Argument type and attributes

*X* must be of type REAL(8).

## Result type and attributes

Same as *X*.

## Result value

The result is a fixed-point integer, inside a floating point result, rounded to zero.

---

## FMADD(*A*, *X*, *Y*)

### Purpose

Floating-point Multiply and Add

Returns the result of a floating-point multiply-add.

### Class

Function

## Argument type and attributes

*A* can be of type REAL(4) or REAL(8).

*X* must be of the same type and kind type parameter as *A*.

*Y* must be of the same type and kind type parameter as *A*.

## Result type and attributes

Same as *A*, *X*, and *Y*.

## Result value

The result has a value equal to  $A * X + Y$ .

## Examples

```
REAL(4) :: A, B, C, RES1
REAL(8) :: D, E, F, RES2

RES1 = FMADD(A, B, C)
RES2 = FMADD(D, E, F)
END
```

---

## FMSUB(A, X, Y)

### Purpose

Floating-point Multiply and Subtract

Returns the result of a floating-point multiply-subtract.

### Class

Function

### Argument type and attributes

**A** can be of type **REAL(4)** or **REAL(8)**.  
**X** must be of the same type and kind type parameter as *A*.  
**Y** must be of the same type and kind type parameter as *A*.

### Result type and attributes

Same as *A*, *X*, and *Y*.

### Result value

The result has a value equal to  $A * X - Y$ .

---

## FNABS(X)

### Purpose

Returns the negative floating-point value  $-|X|$ .

### Class

Function

### Argument type and attributes

**X** must be of type **REAL**.

### Result type and attributes

Same as *X*.

### Result value

The result is a negative floating-point value of *X*,  $-|X|$ .

## Examples

In the following example, the absolute content of a floating-point variable is negated.

```
REAL(4) :: A, RES1
REAL(8) :: D, RES2

RES1 = FNABS(A)
RES2 = FNABS(D)
```

---

## FNMADD(A, X, Y)

### Purpose

Floating-point Negative Multiply and Add

Returns the result of a floating-point negative multiply-add.

### Class

Function

### Argument type and attributes

A	can be of type <b>REAL(4)</b> or <b>REAL(8)</b> .
X	must be of the same type and kind type parameter as <i>A</i> .
Y	must be of the same type and kind type parameter as <i>A</i> .

### Result type and attributes

Same as *X*.

### Result value

The result has a value equal to  $-(A*X + Y)$ .

---

## FNMSUB(A, X, Y)

### Purpose

Floating-point Negative Multiply and Subtract

Returns the result of a floating-point negative multiply-subtract.

### Class

Function

### Argument type and attributes

A	can be of type <b>REAL(4)</b> or <b>REAL(8)</b> .
X	must be of the same type and kind type parameter as <i>A</i> .
Y	must be of the same type and kind type parameter as <i>A</i> .

### Result type and attributes

Same as *A*, *X*, and *Y*.

## Result value

The result has a value equal to  $-(A*X - Y)$ .

## Examples

In the following example, the result of `FNMSUB` is of type `REAL(4)`. It is converted to `REAL(8)` and then assigned to `RES`.

```
REAL(4) :: A, B, C
REAL(8) :: RES

RES = FNMSUB(A, B, C)
END
```

---

## FRE(X)

### Purpose

Floating-point Reciprocal Estimate

Returns an estimate of a floating-point reciprocal operation.

Valid on a POWER5 architecture or higher.

### Class

Function

### Argument type and attributes

`X` must be of type `REAL(8)`.

### Result type and attributes

Same as `X`.

### Result value

The result is a double precision estimate of  $1/X$ .

---

## FRES(X)

### Purpose

Floating-point Reciprocal Estimate Single

Returns an estimate of a floating-point reciprocal operation.

Valid on any PowerPC with extended graphics opcodes. See **Tuning for your target architecture** and the **Instruction groups for a supported architecture** table in the *XL Fortran Optimization and Programming Guide*.

### Class

Function

### Argument type and attributes

`X` must be of type `REAL(4)`.



## Result type and attributes

Same as  $X$ .

## Result value

The result is a single precision estimate of  $1/X$ .

---

## FRIM(A)

### Purpose

Floating-point Round to Integer Minus

Valid on a POWER5+™ architecture or higher.

### Class

Function

### Argument type and attributes

$A$  must be of type REAL(4) or REAL(8).

### Result type and attributes

Same as  $A$ .

### Result value

The result has a value equal to the greatest integer less than or equal to  $A$ .

---

## FRIN(A)

### Purpose

Floating-point Round to Integer Nearest

Valid on a POWER5+ architecture or higher.

### Class

Function

### Argument type and attributes

$A$  must be of type REAL(4) or REAL(8).

### Result type and attributes

Same as  $A$ .

### Result value

If  $A > 0$ , FRIN(A) has the value FRIM(A + 0.5).

If  $A \leq 0$ , FRIN(A) has the value FRIM(A - 0.5).

---

## FRIP(A)

### Purpose

Floating-point Round to Integer Plus

Valid on a POWER5+ architecture or higher.

### Class

Function

### Argument type and attributes

*A* must be of type REAL(4) or REAL(8).

### Result type and attributes

Same as *A*.

### Result value

The result has a value equal to the least integer greater than or equal to *A*.

---

## FRIZ(A)

### Purpose

Floating-point Round to Integer Zero

Valid on a POWER5 architecture or higher.

### Class

Function

### Argument type and attributes

*A* must be of type REAL(4) or REAL(8).

### Result type and attributes

Same as *A*.

### Result value

If  $A > 0$ , FRIZ(A) has the value FRIM(A).

If  $A \leq 0$ , FRIZ(A) has the value FRIP(A).

---

## FRSQRTE(X)

### Purpose

Floating-point Square Root Reciprocal Estimate

Returns the result of a reciprocal square root operation.

Valid on any PowerPC with extended graphics opcodes. See **Tuning for your target architecture** and the **Instruction groups for a supported architecture** table in the *XL Fortran Optimization and Programming Guide*.

## Class

Function

## Argument type and attributes

X must be of type **REAL(8)**.

## Result type and attributes

Same as X.

## Result value

The result is a double precision estimate of the reciprocal of the square root of X.

---

## FRSQRTES(X)

### Purpose

Floating-point Square Root Reciprocal Estimate Single

Returns the result of a reciprocal square root operation.

Valid on a POWER5 architecture or higher.

### Class

Function

### Argument type and attributes

X must be of type **REAL(4)**.

### Result type and attributes

Same as X.

### Result value

The result is a single precision estimate of the reciprocal of the square root of X.

---

## FSEL(X,Y,Z)

### Purpose

Floating-point Selection

Returns the result of a floating-point selection operation. This result is determined by comparing the value of X with zero.

Valid on any PowerPC with extended graphics opcodes. See *Tuning for your target architecture* and the *Instruction groups for a supported architecture* table in the *XL Fortran Optimization and Programming Guide*.

## Class

Function

## Argument type and attributes

*X* must be of type **REAL(4)** or **REAL(8)**.

## Result type and attributes

Same as *X*, *Y* and *Z*.

## Result value

- If the value of *X* is greater than or equal to zero, then the value of *Y* is returned.
- If the value of *X* is smaller than zero or is a NaN, then the value of *Z* is returned.

A zero value is considered unsigned. That is, both +0 and -0 are equal to zero.

---

## MTFSF(MASK, R)

### Purpose

Move to floating-point status and control register (**FPSCR**) fields

The contents of *R* are placed into the **FPSCR** under control of the field mask specified in *MASK*.

### Class

Subroutine

### Argument type and attributes

*MASK* must be a literal value of type **INTEGER(4)**. The lower eight bits are used.

*R* must be of type **REAL(8)**.

---

## MTFSFI(BF, I)

### Purpose

Move to floating-point status and control register (**FPSCR**) Fields Immediate

The value of *I* is placed into **FPSCR** field specified in *BF*.

### Class

Subroutine

### Argument type and attributes

*BF* must be a literal value from 0 to 7, of type **INTEGER(4)**.

*I* must be a literal value from 0 to 15, of type **INTEGER(4)**.

---

## MULHY(RA, RB)

### Purpose

Returns the high-order 32 or 64-bits of the 64-bit or 128-bit products of the operands *RA* and *RB*.

32-bit integers may be used in any compilation mode.

64-bit integers may only be used in 64-bit mode.

### Class

Function

### Argument type and attributes

*RA* must be of type integer.

*RB* must be of type integer.

### Result type and attributes

Same as *RA*, *RB*.

### Result value

A 32 or 64-bit product of the operands *RA* and *RB*

---

## POPCNTB(I)

### Purpose

Population count.

Counts the number of set bits of each byte in a register.

Valid only on POWER5 or higher.

### Class

Elemental function.

### Argument type and attributes

*I* An **INTENT(IN)** argument of type **INTEGER(4)** in 32-bit mode.

An **INTENT(IN)** argument of type **INTEGER(4)** or **INTEGER(8)** in 64-bit mode

### Result type and attributes

Returns an **INTEGER(4)** in 32-bit mode.

Returns an **INTEGER(8)** in 64-bit mode.

### Result value

The number of bits set to on in that byte, in the position of the byte.

## Examples

```
INTEGER I
I = x'010300ff'
WRITE(*, '(z8.8)') POPCNTB(I)
END
```

Expected output:

```
01020008
```

## Related information

Data representation models

---

## ROTATELI(RS, IS, SHIFT, MASK)

### Purpose

Rotate Left Immediate then MASK Insert

Rotates the value of *RS* left by the number of bits specified in *SHIFT*. The function then inserts *RS* into *IS* under bit mask, *MASK*.

### Class

Function

### Argument type and attributes

**RS** must be of type integer.

**IS** must be of type integer.

**SHIFT**

must be a literal value. For 4-byte **RS** values, the **SHIFT** value will be truncated to the last five bits. For 8-byte **RS** values, the **SHIFT** value will be truncated to the last six bits.

**MASK**

must be a literal value of type integer.

### Result type and attributes

Same as *RS*.

### Result value

Rotates *RS* left the number of bits specified by *SHIFT*, and inserts the result into *IS* under the bit mask, *MASK*.

---

## ROTATELM(RS, SHIFT, MASK)

### Purpose

Rotate Left AND with Mask

Rotates the value of *RS* left by the number of bits specified in *SHIFT*. The rotated data is ANDed with the *MASK* and then returned as a result.

## Class

Function

## Argument type and attributes

**RS** must be of type integer.

### SHIFT

must be a literal value. For 4-byte **RS** values, the **SHIFT** value will be truncated to the last five bits. For 8-byte **RS** values, the **SHIFT** value will be truncated to the last six bits.

### MASK

must be a literal value of type integer.

## Result type and attributes

Same as *RS*.

## Result value

The rotated data ANDed with *MASK*.

---

## SETFSB0(BT)

### Purpose

Move 0 to floating-point status and control register (**FPSCR**) bit.

Bit *BT* of **FPSCR** is set to 0. This subroutine returns no value.

### Class

Subroutine

### Argument type and attributes

**BT** must be a literal value from 0 to 31 of type **INTEGER(4)**.

---

## SETFSB1(BT)

### Purpose

Move 1 to **FPSCR** bit.

Bit *BT* of **FPSCR** is set to 1. This subroutine returns no value.

### Class

Subroutine

### Argument type and attributes

**BT** must be a literal value from 0 to 31 of type **INTEGER(4)**.

---

## SFTI(M, Y)

### Purpose

Store Floating-point to Integer

The contents of the low order 32-bits of *Y* are stored without conversion into *M*.

### Class

Subroutine

### Argument type and attributes

*M* must be of type **INTEGER(4)**.

*Y* must be of type **REAL(8)**.

### Examples

```
...
integer*4 :: m
real*8 :: x

x = z"00000000abcd0001"
call sfti(m, x) ! m = z"abcd0001"
..
```

---

## SWDIV(X,Y)

### Purpose

Provides software floating-point division algorithms when targeting and running on POWER5 processors and above.

This function returns the result of a floating-point division and can increase performance over the normal divide operator where your application performs division repeatedly within a loop.

### Class

Elemental function

### Argument type and attributes

*X* can be of type **REAL(4)** or **REAL(8)**.

*Y* must be of the same type and kind type parameter as *X*.

### Result type and attributes

Same as *X* and *Y*.

### Result value

The result has a value equal to  $X/Y$ .

For **REAL(4)** arguments, the result is bitwise identical to IEEE division.



For **REAL(8)** arguments with `-qstrict` in effect, the result is bitwise identical to IEEE division.

For **REAL(8)** arguments with `-qnostrict` in effect, the result can differ slightly from the IEEE result.

## Examples

The following example uses software division algorithms if compiled with the `-qarch=pwr5` option and run on a POWER5 processor.

```
REAL(4) :: A, B DIVRES1
REAL(8) :: E, F DIVRES2

DIVRES1 = SWDIV(A, B)
DIVRES2 = SWDIV(E, F)
END
```

---

## SWDIV\_NOCHK(X,Y)

### Purpose

Provides software floating-point division algorithms when targeting and running on POWER5 processors and above. Checking for invalid arguments is not performed.

This function returns the result of a floating-point division and can increase performance over the normal divide operator or the **SWDIV** built-in function where your application performs division repeatedly within a loop, and arguments are within the permitted range.

### Class

Elemental function

### Argument type and attributes

**X** can be of type **REAL(4)** or **REAL(8)**.

For a **REAL(4)** argument, you must not specify the following:

- $|\text{numerator}|$  equal to infinity
- $|\text{denominator}|$  equal to infinity
- $|\text{denominator}| < 2^{**}(-1022)$
- $|\text{numerator}/\text{denominator}|$  equal to infinity

For correct operation, **REAL(8)** arguments must satisfy the following conditions:

- $2^{**}(-970) < |\text{numerator}| < \text{Inf}$
- $2^{**}(-1022) \leq |\text{denominator}| < 2^{**}1021$
- $2^{**}(-1021) < |\text{numerator}/\text{denominator}| < 2^{**}1023$

**Y** must be of the same type and kind type parameter as **X**.

### Result type and attributes

Same as **X** and **Y**.

## Result value

The result has a value equal to  $X/Y$ .

For **REAL(4)** arguments, the result is bitwise identical to IEEE division.

For **REAL(8)** arguments with `-qstrict` in effect, the result is bitwise identical to IEEE division.

For **REAL(8)** arguments with `-qnostrict` in effect, the result can differ slightly from the IEEE result.

---

## TRAP(A, B, TO)

### Purpose

Operand *A* is compared with operand *B*. This comparison results in five conditions which are ANDed with *TO*. If the result is not 0, the system trap handler is invoked.

8-byte integers are valid only in 64-bit mode.

Both operands *A* and *B* must be either of type **INTEGER(4)** or **INTEGER(8)**.

### Class

Subroutine

### Argument type and attributes

- A** must be of type integer.
- B** must be of type integer.
- TO** must be a literal value from 1 to 31 of type **INTEGER(4)**.

\_\_\_\_\_ End of IBM Extension \_\_\_\_\_

---

## Chapter 16. VMX intrinsic procedures

---

### IBM Extension

---

Individual elements of vectors can be accessed by using storage association, the **TRANSFER** intrinsic, or the Vector Multimedia eXtension (VMX) intrinsic functions. This section provides an alphabetical reference to the Vector Multimedia eXtension (VMX) intrinsic functions. These intrinsics allow you to manipulate vectors.

---

### VEC\_ABS(ARG1)

#### Purpose

Returns a vector containing the absolute values of the contents of the given vector.

#### Class

Elemental function

#### Argument type and attributes

##### ARG1

An INTENT(IN) integer vector or real vector.

#### Result type and attributes

The result is of the same type as ARG1.

#### Result value

The value of each element of the result is the absolute value of the corresponding element of ARG1. For integer vectors, the arithmetic is modular.

---

### VEC\_ABSS(ARG1)

#### Purpose

Returns a vector containing the saturated absolute values of the contents of the given vector.

#### Class

Elemental function

#### Argument type and attributes

##### ARG1

An INTENT(IN) integer vector.

#### Result type and attributes

The result is of the same type as ARG1.

## Result value

The value of each element of the result is the saturated absolute value of the corresponding element of ARG1.

---

## VEC\_ADD(ARG1, ARG2)

### Purpose

Returns a vector containing the sums of each set of corresponding elements of the given vectors.

### Class

Elemental function

### Argument type and attributes

#### ARG1

An INTENT(IN) integer vector, unsigned vector, or real vector.

#### ARG2

An INTENT(IN) vector of the same type as ARG1.

### Result type and attributes

The result is of the same type as ARG1.

## Result value

The value of each element of the result is the sum of the corresponding elements of ARG1 and ARG2. For integer vectors and unsigned vectors, the arithmetic is modular.

---

## VEC\_ADDC(ARG1, ARG2)

### Purpose

Returns a vector containing the carry produced by adding each set of corresponding elements of the given vectors.

### Class

Elemental function

### Argument type and attributes

#### ARG1

An INTENT(IN) UNSIGNED(4) vector.

#### ARG2

An INTENT(IN) vector of the same type as ARG1.

### Result type and attributes

The result is of the same type as ARG1.

## Result value

The value of each element of the result is the carry produced by adding the corresponding elements of ARG1 and ARG2 (1 if there is a carry, 0 otherwise).

---

## VEC\_ADDS(ARG1, ARG2)

### Purpose

Returns a vector containing the saturated sums of each set of corresponding elements of the given vectors.

### Class

Elemental function

### Argument type and attributes

#### ARG1

An INTENT(IN) integer vector or unsigned vector.

#### ARG2

An INTENT(IN) vector of the same type as ARG1.

### Result type and attributes

The result is of the same type as ARG1.

## Result value

The value of each element of the result is the saturated sum of the corresponding elements of ARG1 and ARG2.

---

## VEC\_ALL\_EQ(ARG1, ARG2)

### Purpose

Tests whether all sets of corresponding elements of the given vectors are equal.

### Class

Elemental function

### Argument type and attributes

#### ARG1

An INTENT(IN) vector.

#### ARG2

An INTENT(IN) vector of the same type as ARG1.

### Result type and attributes

The result is an INTEGER(4).

## Result value

The result is 1 if each element of ARG1 is equal to the corresponding element of ARG2. Otherwise, the result is 0.

---

## VEC\_ALL\_GE(ARG1, ARG2)

### Purpose

Tests whether all elements of the first argument are greater than or equal to the corresponding elements of the second argument.

### Class

Elemental function

### Argument type and attributes

#### ARG1

An INTENT(IN) integer vector, real vector, or unsigned vector.

#### ARG2

An INTENT(IN) vector of the same type as ARG1.

### Result type and attributes

The result is an INTEGER(4).

### Result value

The result is 1 if all elements of ARG1 are greater than or equal to the corresponding elements of ARG2. Otherwise, the result is 0.

---

## VEC\_ALL\_GT(ARG1, ARG2)

### Purpose

Tests whether all elements of the first argument are greater than the corresponding elements of the second argument.

### Class

Elemental function

### Argument type and attributes

#### ARG1

An INTENT(IN) integer vector, real vector, or unsigned vector.

#### ARG2

An INTENT(IN) vector of the same type as ARG1.

### Result type and attributes

The result is an INTEGER(4).

### Result value

The result is 1 if all elements of ARG1 are greater than the corresponding elements of ARG2. Otherwise, the result is 0.

---

## VEC\_ALL\_IN(ARG1, ARG2)

### Purpose

Tests whether each element of a given vector is within a given range.

### Class

Elemental function

### Argument type and attributes

#### ARG1

An INTENT(IN) real vector.

#### ARG2

An INTENT(IN) vector of the same type as ARG1.

### Result type and attributes

The result is an INTEGER(4).

### Result value

The result is 1 if all elements of ARG1 have values less than or equal to the value of the corresponding element of ARG2, and greater than or equal to the negative of the value of the corresponding element of ARG2. Otherwise, the result is 0.

---

## VEC\_ALL\_LE(ARG1, ARG2)

### Purpose

Tests whether all elements of the first argument are less than or equal to the corresponding elements of the second argument.

### Class

Elemental function

### Argument type and attributes

#### ARG1

An INTENT(IN) integer vector, real vector, or unsigned vector.

#### ARG2

An INTENT(IN) vector of the same type as ARG1.

### Result type and attributes

The result is an INTEGER(4).

### Result value

The result is 1 if all elements of ARG1 are less than or equal to the corresponding elements of ARG2. Otherwise, the result is 0.

---

## VEC\_ALL\_LT(ARG1, ARG2)

### Purpose

Tests whether all elements of the first argument are less than the corresponding elements of the second argument.

### Class

Elemental function

### Argument type and attributes

#### ARG1

An INTENT(IN) integer vector, real vector, or unsigned vector.

#### ARG2

An INTENT(IN) vector of the same type as ARG1.

### Result type and attributes

The result is an INTEGER(4).

### Result value

The result is 1 if all elements of ARG1 are less than the corresponding elements of ARG2. Otherwise, the result is 0.

---

## VEC\_ALL\_NAN(ARG1)

### Purpose

Tests whether each element of the given vector is a NaN.

### Class

Elemental function

### Argument type and attributes

#### ARG1

An INTENT(IN) real vector.

### Result type and attributes

The result is an INTEGER(4).

### Result value

The result is 1 if each element of ARG1 is a NaN. Otherwise, the result is 0.

---

## VEC\_ALL\_NE(ARG1, ARG2)

### Purpose

Tests whether all sets of corresponding elements of the given vectors are not equal.

### Class

Elemental function



## Argument type and attributes

### ARG1

An INTENT(IN) vector.

### ARG2

An INTENT(IN) vector of the same type as ARG1.

## Result type and attributes

The result is an INTEGER(4).

## Result value

The result is 1 if each element of ARG1 is not equal to the corresponding element of ARG2. Otherwise, the result is 0.

---

## VEC\_ALL\_NGE(ARG1, ARG2)

### Purpose

Tests whether each element of the first argument is not greater than or equal to the corresponding element of the second argument.

### Class

Elemental function

## Argument type and attributes

### ARG1

An INTENT(IN) real vector.

### ARG2

An INTENT(IN) vector of the same type as ARG1.

## Result type and attributes

The result is an INTEGER(4).

## Result value

The result is 1 if each element of ARG1 is not greater than or equal to the corresponding element of ARG2. Otherwise, the result is 0.

---

## VEC\_ALL\_NGT(ARG1, ARG2)

### Purpose

Tests whether each element of the first argument is not greater than the corresponding element of the second argument.

### Class

Elemental function

## Argument type and attributes

### ARG1

An INTENT(IN) real vector.

**ARG2**

An INTENT(IN) vector of the same type as ARG1.

### **Result type and attributes**

The result is an INTEGER(4).

### **Result value**

The result is 1 if each element of ARG1 is not greater than the corresponding element of ARG2. Otherwise, the result is 0.

---

## **VEC\_ALL\_NLE(ARG1, ARG2)**

### **Purpose**

Tests whether each element of the first argument is not less than or equal to the corresponding element of the second argument.

### **Class**

Elemental function

### **Argument type and attributes**

**ARG1**

An INTENT(IN) real vector.

**ARG2**

An INTENT(IN) vector of the same type as ARG1.

### **Result type and attributes**

The result is an INTEGER(4).

### **Result value**

The result is 1 if each element of ARG1 is not less than or equal to the corresponding element of ARG2. Otherwise, the result is 0.

---

## **VEC\_ALL\_NLT(ARG1, ARG2)**

### **Purpose**

Tests whether each element of the first argument is not less than the corresponding element of the second argument.

### **Class**

Elemental function

### **Argument type and attributes**

**ARG1**

An INTENT(IN) real vector.

**ARG2**

An INTENT(IN) vector of the same type as ARG1.

## Result type and attributes

The result is an INTEGER(4).

## Result value

The result is 1 if each element of ARG1 is not less than the corresponding element of ARG2. Otherwise, the result is 0.

---

## VEC\_ALL\_NUMERIC(ARG1)

### Purpose

Tests whether each element of the given vector is numeric (not a NaN).

### Class

Elemental function

### Argument type and attributes

**ARG1**

An INTENT(IN) real vector.

### Result type and attributes

The result is an INTEGER(4).

### Result value

The result is 1 if each element of ARG1 is numeric (not a NaN). Otherwise, the result is 0.

---

## VEC\_AND(ARG1, ARG2)

### Purpose

Performs a bitwise AND of the given vectors.

### Class

Elemental function

### Argument type and attributes

**ARG1**

An INTENT(IN) integer vector, real vector, or unsigned vector.

**ARG2**

An INTENT(IN) vector of the same type as ARG1.

### Result type and attributes

The result is of the same type as ARG1.

### Result value

The result is the bitwise AND of ARG1 and ARG2.

---

## VEC\_ANDC(ARG1, ARG2)

### Purpose

Performs a bitwise AND of the first argument and the bitwise complement of the second argument.

### Class

Elemental function

### Argument type and attributes

#### ARG1

An INTENT(IN) integer vector, real vector, or unsigned vector.

#### ARG2

An INTENT(IN) vector of the same type as ARG1.

### Result type and attributes

The result is of the same type as ARG1.

### Result value

The result is the bitwise AND of ARG1 with the bitwise complement of ARG2.

---

## VEC\_ANY\_EQ(ARG1, ARG2)

### Purpose

Tests whether any set of corresponding elements of the given vectors are equal.

### Class

Elemental function

### Argument type and attributes

#### ARG1

An INTENT(IN) vector.

#### ARG2

An INTENT(IN) vector of the same type as ARG1.

### Result type and attributes

The result is an INTEGER(4).

### Result value

The result is 1 if any element of ARG1 is equal to the corresponding element of ARG2. Otherwise, the result is 0.

---

## VEC\_ANY\_GE(ARG1, ARG2)

### Purpose

Tests whether any element of the first argument is greater than or equal to the corresponding element of the second argument.

## Class

Elemental function

## Argument type and attributes

### ARG1

An INTENT(IN) integer vector, real vector, or unsigned vector.

### ARG2

An INTENT(IN) vector of the same type as ARG1.

## Result type and attributes

The result is an INTEGER(4).

## Result value

The result is 1 if any element of ARG1 is greater than or equal to the corresponding element of ARG2. Otherwise, the result is 0.

---

## VEC\_ANY\_GT(ARG1, ARG2)

### Purpose

Tests whether any element of the first argument is greater than the corresponding element of the second argument.

### Class

Elemental function

## Argument type and attributes

### ARG1

An INTENT(IN) integer vector, real vector, or unsigned vector.

### ARG2

An INTENT(IN) vector of the same type as ARG1.

## Result type and attributes

The result is an INTEGER(4).

## Result value

The result is 1 if any element of ARG1 is greater than the corresponding element of ARG2. Otherwise, the result is 0.

---

## VEC\_ANY\_LE(ARG1, ARG2)

### Purpose

Tests whether any element of the first argument is less than or equal to the corresponding element of the second argument.

### Class

Elemental function

## Argument type and attributes

### ARG1

An INTENT(IN) integer vector, real vector, or unsigned vector.

### ARG2

An INTENT(IN) vector of the same type as ARG1.

## Result type and attributes

The result is an INTEGER(4).

## Result value

The result is 1 if any element of ARG1 is less than or equal to the corresponding element of ARG2. Otherwise, the result is 0.

---

## VEC\_ANY\_LT(ARG1, ARG2)

### Purpose

Tests whether any element of the first argument is less than the corresponding element of the second argument.

### Class

Elemental function

## Argument type and attributes

### ARG1

An INTENT(IN) integer vector, real vector, or unsigned vector.

### ARG2

An INTENT(IN) vector of the same type as ARG1.

## Result type and attributes

The result is an INTEGER(4).

## Result value

The result is 1 if any element of ARG1 is less than the corresponding element of ARG2. Otherwise, the result is 0.

---

## VEC\_ANY\_NAN(ARG1)

### Purpose

Tests whether any element of the given vector is a NaN.

### Class

Elemental function

## Argument type and attributes

### ARG1

An INTENT(IN) real vector.

## Result type and attributes

The result is an INTEGER(4).

## Result value

The result is 1 if any element of ARG1 is a NaN. Otherwise, the result is 0.

---

## VEC\_ANY\_NE(ARG1, ARG2)

### Purpose

Tests whether any set of corresponding elements of the given vectors are not equal.

### Class

Elemental function

### Argument type and attributes

**ARG1**

An INTENT(IN) vector.

**ARG2**

An INTENT(IN) vector of the same type as ARG1.

### Result type and attributes

The result is an INTEGER(4).

### Result value

The result is 1 if any element of ARG1 is not equal to the corresponding element of ARG2. Otherwise, the result is 0.

---

## VEC\_ANY\_NGE(ARG1, ARG2)

### Purpose

Tests whether any element of the first argument is not greater than or equal to the corresponding element of the second argument.

### Class

Elemental function

### Argument type and attributes

**ARG1**

An INTENT(IN) real vector.

**ARG2**

An INTENT(IN) vector of the same type as ARG1.

### Result type and attributes

The result is an INTEGER(4).

## Result value

The result is 1 if any element of ARG1 is not greater than or equal to the corresponding element of ARG2. Otherwise, the result is 0.

---

## VEC\_ANY\_NGT(ARG1, ARG2)

### Purpose

Tests whether any element of the first argument is not greater than the corresponding element of the second argument.

### Class

Elemental function

### Argument type and attributes

#### ARG1

An INTENT(IN) real vector.

#### ARG2

An INTENT(IN) vector of the same type as ARG1.

### Result type and attributes

The result is an INTEGER(4).

### Result value

The result is 1 if any element of ARG1 is not greater than the corresponding element of ARG2. Otherwise, the result is 0.

---

## VEC\_ANY\_NLE(ARG1, ARG2)

### Purpose

Tests whether any element of the first argument is not less than or equal to the corresponding element of the second argument.

### Class

Elemental function

### Argument type and attributes

#### ARG1

An INTENT(IN) real vector.

#### ARG2

An INTENT(IN) vector of the same type as ARG1.

### Result type and attributes

The result is an INTEGER(4).

### Result value

The result is 1 if any element of ARG1 is not less than or equal to the corresponding element of ARG2. Otherwise, the result is 0.



---

## VEC\_ANY\_NLT(ARG1, ARG2)

### Purpose

Tests whether any element of the first argument is not less than the corresponding element of the second argument.

### Class

Elemental function

### Argument type and attributes

#### ARG1

An INTENT(IN) real vector.

#### ARG2

An INTENT(IN) vector of the same type as ARG1.

### Result type and attributes

The result is an INTEGER(4).

### Result value

The result is 1 if any element of ARG1 is not less than the corresponding element of ARG2. Otherwise, the result is 0.

---

## VEC\_ANY\_NUMERIC(ARG1)

### Purpose

Tests whether any element of the given vector is numeric (not a NaN).

### Class

Elemental function

### Argument type and attributes

#### ARG1

An INTENT(IN) real vector.

### Result type and attributes

The result is an INTEGER(4).

### Result value

The result is 1 if any element of ARG1 is numeric (not a NaN). Otherwise, the result is 0.

---

## VEC\_ANY\_OUT(ARG1, ARG2)

### Purpose

Tests whether the value of any element of a given vector is outside of a given range.

## Class

Elemental function

## Argument type and attributes

### ARG1

An INTENT(IN) real vector.

### ARG2

An INTENT(IN) vector of the same type as ARG1.

## Result type and attributes

The result is an INTEGER(4).

## Result value

The result is 1 if the value of any element of ARG1 is greater than the value of the corresponding element of ARG2 or less than the negative of the value of the corresponding element of ARG2. Otherwise, the result is 0.

---

## VEC\_AVG(ARG1, ARG2)

### Purpose

Returns a vector containing the average of each set of corresponding elements of the given vectors.

### Class

Elemental function

## Argument type and attributes

### ARG1

An INTENT(IN) integer vector or unsigned vector.

### ARG2

An INTENT(IN) vector of the same type as ARG1.

## Result type and attributes

The result is a vector of the same type as ARG1.

## Result value

The value of each element of the result is the average of the values of the corresponding elements of ARG1 and ARG2.

---

## VEC\_CEIL(ARG1)

### Purpose

Returns a vector containing the smallest representable floating-point integer values greater than or equal to the values of the corresponding elements of the given vector.

## Class

Elemental function

## Argument type and attributes

### ARG1

An INTENT(IN) real vector.

## Result type and attributes

The result is a vector of the same type as ARG1.

## Result value

Each element of the result contains the smallest representable floating-point integer greater than or equal to the value of the corresponding element of ARG1.

---

## VEC\_CMPB(ARG1, ARG2)

## Purpose

Performs a bounds comparison of each set of corresponding elements of the given vectors.

## Class

Elemental function

## Argument type and attributes

### ARG1

An INTENT(IN) real vector.

### ARG2

An INTENT(IN) vector of the same type as ARG1.

## Result type and attributes

The result is an INTEGER(4) vector.

## Result value

Each element of the result has the value 0 if the value of the corresponding element of ARG1 is less than or equal to the value of the corresponding element of ARG2 and greater than or equal to the negative of the value of the corresponding element of ARG2. Otherwise:

- If an element of ARG2 is greater than or equal to zero, then the value of the corresponding element of the result is 0 if the absolute value of the corresponding element of ARG1 is equal to the value of the corresponding element of ARG2, negative if it is greater than the value of the corresponding element of ARG2, and positive if it is less than the value of the corresponding element of ARG2.
- If an element of ARG2 is less than zero, then the value of the element of the result is positive if the value of the corresponding element of ARG1 is less than or equal to the value of the element of ARG2, and negative otherwise.

---

## VEC\_CMPEQ(ARG1, ARG2)

### Purpose

Returns a vector containing the results of comparing each set of corresponding elements of the given vectors for equality.

### Class

Elemental function

### Argument type and attributes

#### ARG1

An INTENT(IN) integer vector, real vector, or unsigned vector.

#### ARG2

An INTENT(IN) vector of the same type as ARG1.

### Result type and attributes

If ARG1 is an INTEGER(1) vector or UNSIGNED(1) vector, then the result is an UNSIGNED(1) vector. If ARG1 is an INTEGER(2) vector or UNSIGNED(2) vector, then the result is an UNSIGNED(2) vector. Otherwise, the result is an UNSIGNED(4) vector.

### Result value

For each element of the result, the value of each bit is 1 if the corresponding elements of ARG1 and ARG2 are equal. Otherwise, the value of each bit is 0.

---

## VEC\_CMPGE(ARG1, ARG2)

### Purpose

Returns a vector containing the results of a greater-than-or-equal-to comparison between each set of corresponding elements of the given vectors.

### Class

Elemental function

### Argument type and attributes

#### ARG1

An INTENT(IN) real vector.

#### ARG2

An INTENT(IN) vector of the same type as ARG1.

### Result type and attributes

The result is an UNSIGNED(4) vector.

### Result value

For each element of the result, the value of each bit is 1 if the value of the corresponding element of ARG1 is greater than or equal to the value of the corresponding element of ARG2. Otherwise, the value of each bit is 0.

---

## VEC\_CMPGT(ARG1, ARG2)

### Purpose

Returns a vector containing the results of a greater-than comparison between each set of corresponding elements of the given vectors.

### Class

Elemental function

### Argument type and attributes

#### ARG1

An INTENT(IN) integer vector, real vector, or unsigned vector.

#### ARG2

An INTENT(IN) vector of the same type as ARG1.

### Result type and attributes

If ARG1 is an INTEGER(1) vector or UNSIGNED(1) vector, then the result is an UNSIGNED(1) vector. If ARG1 is an INTEGER(2) vector or UNSIGNED(2) vector, then the result is an UNSIGNED(2) vector. Otherwise, the result is an UNSIGNED(4) vector.

### Result value

For each element of the result, the value of each bit is 1 if the value of the corresponding element of ARG1 is greater than the value of the corresponding element of ARG2. Otherwise, the value of each bit is 0.

---

## VEC\_CMPLE(ARG1, ARG2)

### Purpose

Returns a vector containing the results of a less-than-or-equal-to comparison between each set of corresponding elements of the given vectors.

### Class

Elemental function

### Argument type and attributes

#### ARG1

An INTENT(IN) real vector.

#### ARG2

An INTENT(IN) vector of the same type as ARG1.

### Result type and attributes

The result is an UNSIGNED(4) vector.

### Result value

For each element of the result, the value of each bit is 1 if the value of the corresponding element of ARG1 is less than or equal to the value of the corresponding element of ARG2. Otherwise, the value of each bit is 0.

---

## VEC\_CMPLT(ARG1, ARG2)

### Purpose

Returns a vector containing the results of a less-than comparison between each set of corresponding elements of the given vectors.

### Class

Elemental function

### Argument type and attributes

#### ARG1

An INTENT(IN) integer vector, real vector, or unsigned vector.

#### ARG2

An INTENT(IN) vector of the same type as ARG1.

### Result type and attributes

If ARG1 is an INTEGER(1) vector or UNSIGNED(1) vector, then the result is an UNSIGNED(1) vector. If ARG1 is an INTEGER(2) vector or UNSIGNED(2) vector, then the result is an UNSIGNED(2) vector. Otherwise, the result is an UNSIGNED(4) vector.

### Result value

For each element of the result, the value of each bit is 1 if the value of the corresponding element of ARG1 is less than the value of the corresponding element of ARG2. Otherwise, the value of each bit is 0.

---

## VEC\_CONVERT(V, MOLD)

### Purpose

Converts a vector to a vector of a given type.

### Class

Pure function

### Argument type and attributes

V must be an INTENT(IN) vector.

#### MOLD

must be an INTENT(IN) vector. If it is a variable, it need not be defined.

### Result type and attributes

The result is a vector of the same type as MOLD.

### Result value

The result is as if it were on the left-hand side of an intrinsic assignment with V on the right-hand side.

**Note:** This intrinsic function can be used in initialization and specification expressions. It is also the only vector intrinsic function that is not in the C Altivec specification.

---

## VEC\_CTF(ARG1, ARG2)

### Purpose

Converts a vector of fixed-point numbers into a vector of floating-point numbers.

### Class

Elemental function

### Argument type and attributes

#### ARG1

An INTENT(IN) INTEGER(4) vector or UNSIGNED(4) vector.

#### ARG2

An INTENT(IN) integer. Its value must be specified by an initialization expression whose value is between 0 and 31 inclusive.

### Result type and attributes

The result is a REAL(4) vector.

### Result value

The value of each element of the result is the closest floating-point estimate of the value of the corresponding element of ARG1 divided by 2 to the power of ARG2.

---

## VEC\_CTS(ARG1, ARG2)

### Purpose

Converts a vector of floating-point numbers into a vector of signed fixed-point numbers.

### Class

Elemental function

### Argument type and attributes

#### ARG1

must be an INTENT(IN) real vector.

#### ARG2

must be an INTENT(IN) integer. Its value must be specified by an initialization expression whose value is between 0 and 31 inclusive.

### Result type and attributes

The result is an INTEGER(4) vector.

### Result value

The value of each element of the result is the saturated value obtained by multiplying the corresponding element of ARG1 by 2 to the power of ARG2.

---

## VEC\_CTU(ARG1, ARG2)

### Purpose

Converts a vector of floating-point numbers into a vector of unsigned fixed-point numbers.

### Class

Elemental function

### Argument type and attributes

#### ARG1

must be an INTENT(IN) real vector.

#### ARG2

must be an INTENT(IN) integer. Its value must be specified by an initialization expression whose value is between 0 and 31 inclusive.

### Result type and attributes

The result is an UNSIGNED(4) vector.

### Result value

The value of each element of the result is the saturated value obtained by multiplying the corresponding element of ARG1 by 2 to the power of ARG2.

---

## VEC\_DSS(ARG1)

### Purpose

Stops the specified data stream read.

### Class

Subroutine

### Argument type and attributes

#### ARG1

An INTENT(IN) integer and must be specified by an initialization expression whose value is within the range of 0 through 3 inclusive.

Stops the data stream read specified by ARG1.

---

## VEC\_DSSALL

### Purpose

Stops all data stream reads.

### Class

Subroutine



---

## VEC\_DST(ARG1, ARG2, ARG3)

### Purpose

Initiates the data read of a line into cache in a state most efficient for reading.

### Class

Subroutine

### Argument type and attributes

#### ARG1

An INTENT(IN) variable or constant of a vector type or of type INTEGER(1), INTEGER(2), INTEGER(4), or REAL(4).

#### ARG2

An INTENT(IN) integer.

#### ARG3

An INTENT(IN) integer and must be specified by an initialization expression whose value is within the range of 0 through 3 inclusive.

The data stream specified by ARG3 is read beginning at the address of ARG1 using the control word ARG2. Use of this intrinsic indicates that the specified data stream is relatively persistent in nature.

---

## VEC\_DSTST(ARG1, ARG2, ARG3)

### Purpose

Initiates the data read of a line into cache in a state most efficient for writing.

### Class

Subroutine

### Argument type and attributes

#### ARG1

An INTENT(IN) variable or constant of a vector type or of type INTEGER(1), INTEGER(2), INTEGER(4), or REAL(4).

#### ARG2

An INTENT(IN) integer.

#### ARG3

An INTENT(IN) integer and must be specified by an initialization expression whose value is within the range of 0 through 3 inclusive.

The data stream specified by ARG3 is read beginning at the address of ARG1 using the control word ARG2. Use of this intrinsic indicates that the specified data stream is relatively persistent in nature.

---

## VEC\_DSTSTT(ARG1, ARG2, ARG3)

### Purpose

Initiates the data read of a line into cache in a state most efficient for writing.

## Class

Subroutine

## Argument type and attributes

### ARG1

An INTENT(IN) variable or constant of a vector type or of type INTEGER(1), INTEGER(2), INTEGER(4), or REAL(4).

### ARG2

An INTENT(IN) integer.

### ARG3

An INTENT(IN) integer and must be specified by an initialization expression whose value is within the range of 0 through 3 inclusive.

The data stream specified by ARG3 is read beginning at the address of ARG1 using the control word ARG2. Use of this intrinsic indicates that the specified data stream is relatively transient in nature.

---

## VEC\_DSTT(ARG1, ARG2, ARG3)

### Purpose

Initiates the data read of a line into cache in a state most efficient for reading.

## Class

Subroutine

## Argument type and attributes

### ARG1

An INTENT(IN) variable or constant of a vector type or of type INTEGER(1), INTEGER(2), INTEGER(4), or REAL(4).

### ARG2

An INTENT(IN) integer.

### ARG3

An INTENT(IN) integer and must be specified by an initialization expression whose value is within the range of 0 through 3 inclusive.

The data stream specified by ARG3 is read beginning at the address of ARG1 using the control word ARG2. Use of this intrinsic indicates that the specified data stream is relatively transient in nature.

---

## VEC\_EXPTE(ARG1)

### Purpose

Returns a vector containing estimates of 2 raised to the value of the corresponding elements of the given vector.

## Class

Elemental function

## Argument type and attributes

**ARG1**

An INTENT(IN) real vector.

## Result type and attributes

The result is a vector of the same type as ARG1.

## Result value

Each element of the result contains the estimated value of 2 raised to the value of the corresponding element of ARG1.

---

## VEC\_FLOOR(ARG1)

### Purpose

Returns a vector containing the largest representable floating-point integer values less than or equal to the values of the corresponding elements of the given vector.

### Class

Elemental function

## Argument type and attributes

**ARG1**

An INTENT(IN) real vector.

## Result type and attributes

The result is a vector of the same type as ARG1.

## Result value

Each element of the result contains the largest representable floating-point integer less than or equal to the value of the corresponding element of ARG1.

---

## VEC\_LD(ARG1, ARG2)

### Purpose

Loads a vector from a given memory address.

### Class

Function

## Argument type and attributes

**ARG1**

An INTENT(IN) integer.

**ARG2**

An INTENT(IN) integer of type INTEGER(1), INTEGER(2), INTEGER(4), or REAL(4), or any vector type.

## Result type and attributes

If ARG2 is a vector, then the result is of the same type as ARG2. Otherwise, the result is a vector containing elements of the same type as ARG2.

## Result value

ARG1 is added to the address of ARG2, and the sum is truncated to a multiple of 16 bytes. The result is the contents of the 16 bytes of memory starting at this address.

---

## VEC\_LDE(ARG1, ARG2)

### Purpose

Loads an element from a given memory address into a vector.

### Class

Function

### Argument type and attributes

#### ARG1

An INTENT(IN) integer.

#### ARG2

An INTENT(IN) integer of type INTEGER(1), INTEGER(2), INTEGER(4), or REAL(4).

## Result type and attributes

The result is a vector containing elements of the same type as ARG2.

## Result value

The effective address is the sum of ARG1 and the address of ARG2, truncated to a multiple of the size in bytes of an element of the result vector. The contents of memory at the effective address are loaded into the result vector at the byte offset corresponding to the four least significant bits of the effective address. The remaining portions of the result vector are undefined.

---

## VEC\_LDL(ARG1, ARG2)

### Purpose

Loads a vector from a given memory address, and marks the data as Least Recently Used.

### Class

Function

### Argument type and attributes

#### ARG1

An INTENT(IN) integer.

#### ARG2

An INTENT(IN) integer of type INTEGER(1), INTEGER(2), INTEGER(4), REAL(4) or any vector type.

## Result type and attributes

If ARG2 is a vector, then the result is of the same type as ARG2. Otherwise, the result is a vector containing elements of the same type as ARG2.

## Result value

ARG1 is added to the address of ARG2, and the sum is truncated to a multiple of 16 bytes. The result is the contents of the 16 bytes of memory starting at this address. This data is marked as Least Recently Used.

---

## VEC\_LOGE(ARG1)

### Purpose

Returns a vector containing estimates of the base-2 logarithms of the corresponding elements of the given vector.

### Class

Elemental function

## Argument type and attributes

**ARG1**  
An INTENT(IN) real vector.

## Result type and attributes

The result is a vector of the same type as ARG1.

## Result value

Each element of the result contains the estimated value of the base-2 logarithm of the corresponding element of ARG1.

---

## VEC\_LVSL(ARG1, ARG2)

### Purpose

Returns a vector useful for aligning non-aligned data.

### Class

Function

## Argument type and attributes

**ARG1**  
An INTENT(IN) integer.

**ARG2**  
An INTENT(IN) integer of type INTEGER(1), INTEGER(2), INTEGER(4), or REAL(4).

## Result type and attributes

The result is an UNSIGNED(1) vector.

## Result value

The first element of the result vector is the sum of ARG1 and the address of ARG2, modulo 16. Each successive element contains the previous element's value plus 1.

---

## VEC\_LVSR(ARG1, ARG2)

### Purpose

Returns a vector useful for aligning non-aligned data.

### Class

Function

### Argument type and attributes

#### ARG1

An INTENT(IN) integer.

#### ARG2

An INTENT(IN) integer of type INTEGER(1), INTEGER(2), INTEGER(4), or REAL(4).

### Result type and attributes

The result is an UNSIGNED(1) vector.

## Result value

The effective address is the sum of ARG1 and the address of ARG2, modulo 16. The first element of the result vector contains the value 16 minus the effective address. Each successive element contains the previous element's value plus 1.

---

## VEC\_MADD(ARG1, ARG2, ARG3)

### Purpose

Returns a vector containing the results of performing a fused multiply/add for each corresponding set of elements of the given vectors.

### Class

Elemental function

### Argument type and attributes

#### ARG1

An INTENT(IN) real vector.

#### ARG2

An INTENT(IN) vector of the same type as ARG1.

#### ARG3

An INTENT(IN) vector of the same type as ARG1.

### Result type and attributes

The result is of the same type as ARG1.

## Result value

The value of each element of the result is the product of the values of the corresponding elements of ARG1 and ARG2, added to the value of the corresponding element of ARG3.

---

## VEC\_MADDS(ARG1, ARG2)

### Purpose

Returns a vector containing the results of performing a saturated multiply-high-and-add operation for each corresponding set of elements of the given vectors.

### Class

Elemental function

### Argument type and attributes

#### ARG1

An INTENT(IN) INTEGER(2) vector.

#### ARG2

An INTENT(IN) vector of the same type as ARG1.

#### ARG3

An INTENT(IN) vector of the same type as ARG1.

### Result type and attributes

The result is of the same type as ARG1.

### Result value

For each element of the result, the value is produced in the following way: The values of the corresponding elements of ARG1 and ARG2 are multiplied. The value of the 17 most significant bits of this product is then added, using 16-bit-saturated addition, to the value of the corresponding element of ARG3.

---

## VEC\_MAX(ARG1, ARG2)

### Purpose

Returns a vector containing the maximum value from each set of corresponding elements of the given vectors.

### Class

Elemental function

### Argument type and attributes

#### ARG1

An INTENT(IN) integer vector, real vector, or unsigned vector.

#### ARG2

An INTENT(IN) vector of the same type as ARG1.

## Result type and attributes

The result is a vector of the same type as ARG1.

## Result value

The value of each element of the result is the maximum of the values of the corresponding elements of ARG1 and ARG2.

---

## VEC\_MERGEH(ARG1, ARG2)

### Purpose

Merges the most significant halves of two vectors.

### Class

Elemental function

### Argument type and attributes

**ARG1**

An INTENT(IN) vector.

**ARG2**

An INTENT(IN) vector of the same type as ARG1.

### Result type and attributes

The result is of the same type as ARG1.

### Result value

Assume that the elements of each vector are numbered beginning with 0. The even-numbered elements of the result are taken, in order, from the elements in the most significant 8 bytes of ARG1. The odd-numbered elements of the result are taken, in order, from the elements in the most significant 8 bytes of ARG2.

---

## VEC\_MERGEL(ARG1, ARG2)

### Purpose

Merges the least significant halves of two vectors.

### Class

Elemental function

### Argument type and attributes

**ARG1**

An INTENT(IN) vector.

**ARG2**

An INTENT(IN) vector of the same type as ARG1.

### Result type and attributes

The result is of the same type as ARG1.



## Result value

Assume that the elements of each vector are numbered beginning with 0. The even-numbered elements of the result are taken, in order, from the elements in the least significant 8 bytes of ARG1. The odd-numbered elements of the result are taken, in order, from the elements in the least significant 8 bytes of ARG2.

---

## VEC\_MFVSCR

### Purpose

Copies the contents of the Vector Status and Control Register into the result vector.

### Class

Function

### Result type and attributes

The result is an UNSIGNED(2) vector.

### Result value

The high-order 16 bits of the VSCR are copied into the seventh element of the result. The low-order 16 bits of the VSCR are copied into the eighth element of the result. All other elements are set to zero.

---

## VEC\_MIN(ARG1, ARG2)

### Purpose

Returns a vector containing the minimum value from each set of corresponding elements of the given vectors.

### Class

Elemental function

### Argument type and attributes

#### ARG1

An INTENT(IN) integer vector, real vector, or unsigned vector.

#### ARG2

An INTENT(IN) vector of the same type as ARG1.

### Result type and attributes

The result is a vector of the same type as ARG1.

### Result value

The value of each element of the result is the minimum of the values of the corresponding elements of ARG1 and ARG2.

---

## VEC\_MLADD(ARG1, ARG2, ARG3)

### Purpose

Returns a vector containing the results of performing a saturated multiply-low-and-add operation for each corresponding set of elements of the given vectors.

### Class

Elemental function

### Argument type and attributes

#### ARG1

An INTENT(IN) INTEGER(2) vector or UNSIGNED(2) vector.

#### ARG2

An INTENT(IN) INTEGER(2) vector or UNSIGNED(2) vector.

#### ARG3

An INTENT(IN) vector of the same type as ARG2.

### Result type and attributes

If ARG1, ARG2, and ARG3 are all unsigned vectors, then the result is an UNSIGNED(2) vector. Otherwise, the result is an INTEGER(2) vector.

### Result value

The value of each element of the result is the value of the least significant 16 bits of the product of the values of the corresponding elements of ARG1 and ARG2, added to the value of the corresponding element of ARG3.

The addition is performed using modular arithmetic.

---

## VEC\_MRADD(ARG1, ARG2, ARG3)

### Purpose

Returns a vector containing the results of performing a saturated multiply-high-round-and-add operation for each corresponding set of elements of the given vectors.

### Class

Elemental function

### Argument type and attributes

#### ARG1

An INTENT(IN) INTEGER(2) vector.

#### ARG2

An INTENT(IN) vector of the same type as ARG1.

#### ARG3

An INTENT(IN) vector of the same type as ARG1.

## Result type and attributes

The result is of the same type as ARG1.

## Result value

For each element of the result, the value is produced in the following way: The values of the corresponding elements of ARG1 and ARG2 are multiplied and rounded such that the 15 least significant bits are 0. The value of the 17 most significant bits of this rounded product is then added, using 16-bit-saturated addition, to the value of the corresponding element of ARG3.

---

## VEC\_MSUM(ARG1, ARG2, ARG3)

### Purpose

Returns a vector containing the results of performing a multiply-sum operation using the given vectors.

### Class

Elemental function

## Argument type and attributes

### ARG1

An INTENT(IN) INTEGER(1) vector, INTEGER(2) vector, UNSIGNED(1) vector, or UNSIGNED(2) vector.

### ARG2

An INTENT(IN) vector. If ARG1 is an INTEGER(1) vector, then ARG2 is an UNSIGNED(1) vector. Otherwise, ARG2 is of the same type as ARG1.

### ARG3

An INTENT(IN) vector. If ARG1 is an integer vector, then ARG3 is an INTEGER(4) vector. If ARG1 is an unsigned vector, then ARG3 is an UNSIGNED(4) vector.

## Result type and attributes

The result is a vector of the same type as ARG3.

## Result value

Assume that the elements of each vector are numbered beginning with 0. If ARG1 is an INTEGER(1) vector or an UNSIGNED(1) vector, then let  $m$  be 4. Otherwise, let  $m$  be 2. For each element  $n$  of the result vector, the value is obtained in the following way: For  $p = mn$  to  $mn+m-1$ , multiply element  $p$  of ARG1 by element  $p$  of ARG2. Add the sum of these products to element  $n$  of ARG3. All additions are performed using 32-bit modular arithmetic.

---

## VEC\_MSUMS(ARG1, ARG2, ARG3)

### Purpose

Returns a vector containing the results of performing a saturated multiply-sum operation using the given vectors.

### Class

Elemental function

## Argument type and attributes

### ARG1

An INTENT(IN) INTEGER(2) vector or UNSIGNED(2) vector.

### ARG2

An INTENT(IN) vector of the same type as ARG1.

### ARG3

An INTENT(IN) vector. If ARG1 is an integer vector, then ARG3 is an INTEGER(4) vector. If ARG1 is an unsigned vector, then ARG3 is an UNSIGNED(4) vector.

## Result type and attributes

The result is a vector of the same type as ARG3.

## Result value

Assume that the elements of each vector are numbered beginning with 0. For each element  $n$  of the result vector, the value is obtained in the following way: For  $p = 2n$  to  $2n+1$ , multiply element  $p$  of ARG1 by element  $p$  of ARG2. Add the sum of these products to element  $n$  of ARG3. All additions are performed using 32-bit saturated arithmetic.

---

## VEC\_MTVSCR(ARG1)

### Purpose

Copies the given value into the Vector Status and Control Register.

### Class

Subroutine

## Argument type and attributes

### ARG1

An INTENT(IN) integer vector, unsigned vector, or pixel vector.  
The low-order 32 bits of ARG1 are copied into the VSCR.

---

## VEC\_MULE(ARG1, ARG2)

### Purpose

Returns a vector containing the results of multiplying every second corresponding set of elements of the given vectors, beginning with the first element.

### Class

Elemental function

## Argument type and attributes

### ARG1

An INTENT(IN) INTEGER(1) vector, INTEGER(2) vector, UNSIGNED(1) vector, or UNSIGNED(2) vector.

### ARG2

An INTENT(IN) vector of the same type as ARG1.

## Result type and attributes

If ARG1 is an INTEGER(1) vector, then the result is an INTEGER(2) vector. If ARG1 is an INTEGER(2) vector, then the result is an INTEGER(4) vector. If ARG1 is an UNSIGNED(1) vector, then the result is an UNSIGNED(2) vector. If ARG1 is an UNSIGNED(2) vector, then the result is an UNSIGNED(4) vector.

## Result value

Assume that the elements of each vector are numbered beginning with 0. For each element  $n$  of the result vector, the value is the product of the value of element  $2n$  of ARG1 and the value of element  $2n$  of ARG2.

---

## VEC\_MULO(ARG1, ARG2)

### Purpose

Returns a vector containing the results of multiplying every second corresponding set of elements of the given vectors, beginning with the second element.

### Class

Elemental function

## Argument type and attributes

### ARG1

An INTENT(IN) INTEGER(1) vector, INTEGER(2) vector, UNSIGNED(1) vector, or UNSIGNED(2) vector.

### ARG2

An INTENT(IN) vector of the same type as ARG1.

## Result type and attributes

If ARG1 is an INTEGER(1) vector, then the result is an INTEGER(2) vector. If ARG1 is an INTEGER(2) vector, then the result is an INTEGER(4) vector. If ARG1 is an UNSIGNED(1) vector, then the result is an UNSIGNED(2) vector. If ARG1 is an UNSIGNED(2) vector, then the result is an UNSIGNED(4) vector.

## Result value

Assume that the elements of each vector are numbered beginning with 0. For each element  $n$  of the result vector, the value is the product of the value of element  $2n+1$  of ARG1 and the value of element  $2n+1$  of ARG2.

---

## VEC\_NMSUB(ARG1, ARG2, ARG3)

### Purpose

Returns a vector containing the results of performing a negative multiply-subtract operation on the given vectors.

### Class

Elemental function

## Argument type and attributes

### ARG1

An INTENT(IN) real vector.

### ARG2

An INTENT(IN) vector of the same type as ARG1.

### ARG3

An INTENT(IN) vector of the same type as ARG1.

## Result type and attributes

The result is a vector of the same type as ARG1.

## Result value

The value of each element of the result is the product of the corresponding elements of ARG1 and ARG2, subtracted from the corresponding element of ARG3.

---

## VEC\_NOR(ARG1, ARG2)

### Purpose

Performs a bitwise NOR of the given vectors.

### Class

Elemental function

## Argument type and attributes

### ARG1

An INTENT(IN) integer vector, real vector, or unsigned vector.

### ARG2

An INTENT(IN) vector of the same type as ARG1.

## Result type and attributes

The result is of the same type as ARG1.

## Result value

The result is the bitwise NOR of ARG1 and ARG2.

---

## VEC\_OR(ARG1, ARG2)

### Purpose

Performs a bitwise OR of the given vectors.

### Class

Elemental function

## Argument type and attributes

### ARG1

An INTENT(IN) integer vector, real vector, or unsigned vector.

**ARG2**

An INTENT(IN) vector of the same type as ARG1.

## Result type and attributes

The result is of the same type as ARG1.

## Result value

The result is the bitwise OR of ARG1 and ARG2.

---

## VEC\_PACK(ARG1, ARG2)

### Purpose

Packs information from each element of two vectors into the result vector.

### Class

Elemental function

### Argument type and attributes

**ARG1**

An INTENT(IN) integer vector or unsigned vector whose elements are of kind 2 or 4.

**ARG2**

An INTENT(IN) vector of the same type as ARG1.

### Result type and attributes

If ARG1 is an INTEGER(2) vector, then the result is an INTEGER(1) vector. If ARG1 is an INTEGER(4) vector, then the result is an INTEGER(2) vector. If ARG1 is an UNSIGNED(2) vector, then the result is an UNSIGNED(1) vector. If ARG1 is an UNSIGNED(4) vector, then the result is an UNSIGNED(2) vector.

### Result value

The value of each element of the result vector is taken from the low-order half of the corresponding element of the result of concatenating ARG1 and ARG2.

---

## VEC\_PACKPX(ARG1, ARG2)

### Purpose

Packs information from each element of two vectors into the result vector.

### Class

Elemental function

### Argument type and attributes

**ARG1**

An INTENT(IN) UNSIGNED(4) vector.

**ARG2**

An INTENT(IN) vector of the same type as ARG1.

## Result type and attributes

The result is a pixel vector.

## Result value

The value of each element of the result vector is taken from the corresponding element of the result of concatenating ARG1 and ARG2 in the following way: the least significant bit of the high order byte is stored into the first bit of the result element; the least significant 5 bits of each of the remaining bytes are stored into the remaining portion of the result element.

---

## VEC\_PACKS(ARG1, ARG2)

### Purpose

Packs information from each element of two vectors into the result vector, using saturated values.

### Class

Elemental function

## Argument type and attributes

### ARG1

An INTENT(IN) integer vector or unsigned vector whose elements are of kind 2 or 4.

### ARG2

An INTENT(IN) vector of the same type as ARG1.

## Result type and attributes

If ARG1 is an INTEGER(2) vector, then the result is an INTEGER(1) vector.

If ARG1 is an INTEGER(4) vector, then the result is an INTEGER(2) vector.

If ARG1 is an UNSIGNED(2) vector, then the result is an UNSIGNED(1) vector.

If ARG1 is an UNSIGNED(4) vector, then the result is an UNSIGNED(2) vector.

## Result value

The value of each element of the result vector is the saturated value of the corresponding element of the result of concatenating ARG1 and ARG2.

---

## VEC\_PACKSU(ARG1, ARG2)

### Purpose

Packs information from each element of two vectors into the result vector, using saturated values.

### Class

Elemental function



## Argument type and attributes

### ARG1

An INTENT(IN) integer or unsigned vector whose elements are of kind 2 or 4.

### ARG2

An INTENT(IN) vector of the same type as ARG1.

## Result type and attributes

If ARG1 is an INTEGER(2) vector or an UNSIGNED(2) vector, then the result is an UNSIGNED(1) vector. If ARG1 is an INTEGER(4) vector or an UNSIGNED(4) vector, then the result is an UNSIGNED(2) vector.

## Result value

The value of each element of the result vector is the saturated value of the corresponding element of the result of concatenating ARG1 and ARG2.

---

## VEC\_PERM(ARG1, ARG2, ARG3)

### Purpose

Returns a vector that contains some elements of two vectors, in the order specified by a third vector.

### Class

Elemental function

## Argument type and attributes

### ARG1

An INTENT(IN) vector.

### ARG2

An INTENT(IN) vector of the same type as ARG1.

### ARG3

An INTENT(IN), UNSIGNED(1) vector.

## Result type and attributes

The result is of the same type as ARG1.

## Result value

Each byte of the result is selected by using the least significant 5 bits of the corresponding byte of ARG3 as an index into the concatenated bytes of ARG1 and ARG2.

---

## VEC\_RE(ARG1)

### Purpose

Returns a vector containing estimates of the reciprocals of the corresponding elements of the given vector.

## Class

Elemental function

## Argument type and attributes

### ARG1

An INTENT(IN) real vector.

## Result type and attributes

The result is a vector of the same type as ARG1.

## Result value

Each element of the result contains the estimated value of the reciprocal of the corresponding element of ARG1.

---

## VEC\_RL(ARG1, ARG2)

## Purpose

Rotates each element of a vector left by a given number of bits.

## Class

Elemental function

## Argument type and attributes

### ARG1

An INTENT(IN) integer vector or unsigned vector.

### ARG2

An INTENT(IN) unsigned vector containing elements of the same kind as the elements of ARG1.

## Result type and attributes

The result is of the same type as ARG1.

## Result value

Each element of the result is obtained by rotating the corresponding element of ARG1 left by the number of bits specified by the corresponding element of ARG2.

---

## VEC\_ROUND(ARG1)

## Purpose

Returns a vector containing the rounded values of the corresponding elements of the given vector.

## Class

Elemental function

## Argument type and attributes

**ARG1**

An INTENT(IN) real vector.

## Result type and attributes

The result is a vector of the same type as ARG1.

## Result value

Each element of the result contains the value of the corresponding element of ARG1, rounded to the nearest representable floating-point integer, using IEEE round-to-nearest rounding.

---

## VEC\_RSQRTE(ARG1)

### Purpose

Returns a vector containing estimates of the reciprocal square roots of the corresponding elements of the given vector.

### Class

Elemental function

## Argument type and attributes

**ARG1**

An INTENT(IN) real vector.

## Result type and attributes

The result is a vector of the same type as ARG1.

## Result value

Each element of the result contains the estimated value of the reciprocal square root of the corresponding element of ARG1.

---

## VEC\_SEL(ARG1, ARG2, ARG3)

### Purpose

Selectively merges two vectors.

### Class

Elemental function

## Argument type and attributes

**ARG1**

INTENT(IN) integer vector, real vector, or unsigned vector.

**ARG2**

An INTENT(IN) vector of the same type as ARG1.

### ARG3

An INTENT(IN) unsigned vector containing elements with the same kind as the elements of ARG1.

## Result type and attributes

The result is of the same type as ARG1.

## Result value

Each bit of the result vector has the value of the corresponding bit of ARG1 if the corresponding bit of ARG3 is 0, or the value of the corresponding bit of ARG2 otherwise.

---

## VEC\_SL(ARG1, ARG2)

### Purpose

Performs a left shift for each element of a vector.

### Class

Elemental function

## Argument type and attributes

### ARG1

An INTENT(IN) integer vector or unsigned vector.

### ARG2

An INTENT(IN) unsigned vector containing elements of the same kind as the elements of ARG1.

## Result type and attributes

The result is of the same type as ARG1.

## Result value

Each element of the result vector is the result of left shifting the corresponding element of ARG1 by the number of bits specified by the value of the corresponding element of ARG2, modulo the number of bits in the element. The bits that are shifted out are replaced by zeroes.

---

## VEC\_SLD(ARG1, ARG2, ARG3)

### Purpose

Left shifts two concatenated vectors by a given number of bytes.

### Class

Elemental function

## Argument type and attributes

### ARG1

An INTENT(IN) vector.

**ARG2**

An INTENT(IN) vector of the same type as ARG1.

**ARG3**

An INTENT(IN) integer. It must be specified by an initialization expression whose value is within the range of 0 through 15 inclusive.

**Result type and attributes**

The result is of the same type as ARG1.

**Result value**

The result is the most significant 16 bytes obtained by concatenating ARG1 and ARG2, and shifting left by the number of bytes specified by ARG3.

---

**VEC\_SLL(ARG1, ARG2)****Purpose**

Left shifts a vector by a given number of bits.

**Class**

Elemental function

**Argument type and attributes****ARG1**

An INTENT(IN) integer vector, unsigned vector, or pixel vector.

**ARG2**

An INTENT(IN) unsigned vector. Each byte of ARG2 must contain the same value.

**Result type and attributes**

The result is of the same type as ARG1.

**Result value**

The result is the contents of ARG1, shifted left by the number of bits specified by the 3 least significant bits of ARG2. The bits that are shifted out are replaced by zeroes.

---

**VEC\_SLO(ARG1, ARG2)****Purpose**

Left shifts a vector by a given number of bytes (octets).

**Class**

Elemental function

**Argument type and attributes****ARG1**

An INTENT(IN) vector.

### ARG2

An INTENT(IN) unsigned vector containing elements of kind 1 or 2.

## Result type and attributes

The result is of the same type as ARG1.

## Result value

The result is the contents of ARG1, shifted left by the number of bytes specified by bits 121 through 124 of ARG2. The bits that are shifted out are replaced by zeroes.

---

## VEC\_SPLAT(ARG1, ARG2)

### Purpose

Returns a vector that has all of its elements set to a given value.

### Class

Elemental function

## Argument type and attributes

### ARG1

An INTENT(IN) vector.

### ARG2

An INTENT(IN) integer. Its value must be specified by an initialization expression that is greater than or equal to 0, and less than the number of elements in ARG1.

## Result type and attributes

The result is of the same type as ARG1.

## Result value

Assume that the elements of ARG1 are numbered beginning with 0. The value of the element of ARG1 specified by ARG2 is given to each element of the result vector.

---

## VEC\_SPLAT\_S8(ARG1)

### Purpose

Returns a vector with all elements equal to the given value.

### Class

Elemental function

## Argument type and attributes

### ARG1

An INTENT(IN) integer. Its value must be specified by an initialization expression whose value is between -16 and 15 inclusive.

## Result type and attributes

The result is an INTEGER(1) vector.

## Result value

Each element of the result has the value of ARG1.

---

## VEC\_SPLAT\_S16(ARG1)

### Purpose

Returns a vector with all elements equal to the given value.

### Class

Elemental function

### Argument type and attributes

#### ARG1

An INTENT(IN) integer. Its value must be specified by an initialization expression whose value is between -16 and 15 inclusive.

### Result type and attributes

The result is an INTEGER(2) vector.

## Result value

Each element of the result has the value of ARG1.

---

## VEC\_SPLAT\_S32(ARG1)

### Purpose

Returns a vector with all elements equal to the given value.

### Class

Elemental function

### Argument type and attributes

#### ARG1

An INTENT(IN) integer. Its value must be specified by an initialization expression whose value is between -16 and 15 inclusive.

### Result type and attributes

The result is an INTEGER(4) vector.

## Result value

Each element of the result has the value of ARG1.

---

## VEC\_SPLAT\_U8(ARG1)

### Purpose

Returns a vector with all elements equal to the given value.

## Class

Elemental function

## Argument type and attributes

### ARG1

An INTENT(IN) integer. Its value must be specified by an initialization expression whose value is between -16 and 15 inclusive.

## Result type and attributes

The result is an UNSIGNED(1) vector.

## Result value

The bit pattern of ARG1 is interpreted as an unsigned value. Each element of the result is given this value.

---

## VEC\_SPLAT\_U16(ARG1)

### Purpose

Returns a vector with all elements equal to the given value.

### Class

Elemental function

## Argument type and attributes

### ARG1

An INTENT(IN) integer. Its value must be specified by an initialization expression whose value is between -16 and 15 inclusive.

## Result type and attributes

The result is an UNSIGNED(2) vector.

## Result value

The bit pattern of ARG1 is interpreted as an unsigned value. Each element of the result is given this value.

---

## VEC\_SPLAT\_U32(ARG1)

### Purpose

Returns a vector with all elements equal to the given value.

### Class

Elemental function

## Argument type and attributes

### ARG1

An INTENT(IN) integer. Its value must be specified by an initialization expression whose value is between -16 and 15 inclusive.



## Result type and attributes

The result is an UNSIGNED(4) vector.

## Result value

The bit pattern of ARG1 is interpreted as an unsigned value. Each element of the result is given this value.

---

## VEC\_SR(ARG1, ARG2)

### Purpose

Performs a right shift for each element of a vector.

### Class

Elemental function

## Argument type and attributes

### ARG1

An INTENT(IN) integer vector or unsigned vector.

### ARG2

An INTENT(IN) unsigned vector containing elements of the same kind as the elements of ARG1.

## Result type and attributes

The result is of the same type as ARG1.

## Result value

Each element of the result vector is the result of right shifting the corresponding element of ARG1 by the number of bits specified by the value of the corresponding element of ARG2, modulo the number of bits in the element. The bits that are shifted out are replaced by zeroes.

---

## VEC\_SRA(ARG1, ARG2)

### Purpose

Performs an algebraic right shift for each element of a vector.

### Class

Elemental function

## Argument type and attributes

### ARG1

An INTENT(IN) integer vector or unsigned vector.

### ARG2

An INTENT(IN) unsigned vector containing elements of the same kind as the elements of ARG1.

## Result type and attributes

The result is of the same type as ARG1.

## Result value

Each element of the result vector is the result of algebraically right shifting the corresponding element of ARG1 by the number of bits specified by the value of the corresponding element of ARG2, modulo the number of bits in the element. The bits that are shifted out are replaced by copies of the most significant bit of the element of ARG1.

---

## VEC\_SRL(ARG1, ARG2)

### Purpose

Right shifts a vector by a given number of bits.

### Class

Elemental function

### Argument type and attributes

#### ARG1

An INTENT(IN) integer vector, unsigned vector, or pixel vector.

#### ARG2

An INTENT(IN) unsigned vector. Each byte of ARG2 must contain the same value.

### Result type and attributes

The result is of the same type as ARG1.

### Result value

The result is the contents of ARG1, shifted right by the number of bits specified by the 3 least significant bits of ARG2. The bits that are shifted out are replaced by zeroes.

---

## VEC\_SRO(ARG1, ARG2)

### Purpose

Right shifts a vector by a given number of bytes (octets).

### Class

Elemental function

### Argument type and attributes

#### ARG1

An INTENT(IN) vector.

#### ARG2

An INTENT(IN) unsigned vector whose elements are of kind 1 or 2.

## Result type and attributes

The result is of the same type as ARG1.

## Result value

The result is the contents of ARG1, shifted right by the number of bytes specified by bits 121 through 124 of ARG2. The bits that are shifted out are replaced by zeroes.

---

## VEC\_ST(ARG1, ARG2, ARG3)

### Purpose

Stores a vector into memory at the given address.

### Class

Subroutine

## Argument type and attributes

### ARG1

An INTENT(IN) vector.

### ARG2

An INTENT(IN) integer.

### ARG3

is INTENT(OUT). It must be a vector or be of type integer or real as follows:

#### Case (i)

If ARG3 is a vector, it must be of the same type as ARG1.

#### Case (ii)

If ARG3 is not a vector, and ARG1 is an integer vector or an unsigned vector, then ARG3 must be of type integer with the same kind type parameter as the elements of ARG1.

#### Case (iii)

If ARG3 is not a vector, and ARG1 is a real vector, then ARG3 must be of the same type and kind as the elements of ARG1.

#### Case (iv)

If ARG3 is not a vector, and ARG1 is a pixel vector, then ARG3 must be of type INTEGER(2).

ARG2 is added to the address of ARG3, and the sum is truncated to a multiple of 16 bytes. The value of ARG1 is then stored into this memory address.

---

## VEC\_STE(ARG1, ARG2, ARG3)

### Purpose

Stores a vector element into memory at the given address.

### Class

Subroutine

## Argument type and attributes

### ARG1

An INTENT(IN) vector.

### ARG2

An INTENT(IN) integer.

### ARG3

is INTENT(OUT). If ARG1 is a pixel vector, then ARG3 must be of type INTEGER(2). If ARG1 is an unsigned vector, then ARG3 must be of type integer and must have the same kind as the elements of ARG1. Otherwise, ARG3 must have the same type and kind as the elements of ARG1.

The effective address is the sum of ARG2 and the address of ARG3, truncated to a multiple of the size in bytes of an element of the result vector. The value of the element of ARG1 at the byte offset that corresponds to the four least significant bits of the effective address is stored into memory at the effective address.

---

## VEC\_STL(ARG1, ARG2, ARG3)

### Purpose

Stores a vector into memory at the given address, and marks the data as Least Recently Used.

### Class

Subroutine

## Argument type and attributes

### ARG1

An INTENT(IN) vector.

### ARG2

An INTENT(IN) integer.

### ARG3

is INTENT(OUT). It must be a vector or be of type integer or real as follows:

#### Case (i)

If ARG3 is a vector, it must be of the same type as ARG1.

#### Case (ii)

If ARG3 is not a vector, and ARG1 is an integer vector or an unsigned vector, then ARG3 must be of type integer with the same kind type parameter as the elements of ARG1.

#### Case (iii)

If ARG3 is not a vector, and ARG1 is a real vector, then ARG3 must be of the same type and kind as the elements of ARG1.

#### Case (iv)

If ARG3 is not a vector, and ARG1 is a pixel vector, then ARG3 must be of type INTEGER(2).

ARG2 is added to the address of ARG3, and the sum is truncated to a multiple of 16 bytes. The value of ARG1 is then stored into this memory address. The data is marked as Least Recently Used.

---

## VEC\_SUB(ARG1, ARG2)

### Purpose

Returns a vector containing the differences of each set of corresponding elements of the given vectors.

### Class

Elemental function

### Argument type and attributes

#### ARG1

An INTENT(IN) integer vector, unsigned vector, or real vector.

#### ARG2

An INTENT(IN) vector of the same type as ARG1.

### Result type and attributes

The result is of the same type as ARG1.

### Result value

The value of each element of the result is the result of subtracting the value of the corresponding element of ARG2 from the value of the corresponding element of ARG1. The arithmetic is modular for integer vectors.

---

## VEC\_SUBC(ARG1, ARG2)

### Purpose

Returns a vector containing the carry produced by subtracting each set of corresponding elements of the given vectors.

### Class

Elemental function

### Argument type and attributes

#### ARG1

An INTENT(IN) UNSIGNED(4) vector.

#### ARG2

An INTENT(IN) vector of the same type as ARG1.

### Result type and attributes

The result is of the same type as ARG1.

### Result value

The value of each element of the result is the value of the carry produced by subtracting the value of the corresponding element of ARG2 from the value of the corresponding element of ARG1. The value is 0 if a borrow occurred, or 1 if no borrow occurred.

---

## VEC\_SUBS(ARG1, ARG2)

### Purpose

Returns a vector containing the saturated differences of each set of corresponding elements of the given vectors.

### Class

Elemental function

### Argument type and attributes

#### ARG1

An INTENT(IN) integer vector or unsigned vector.

#### ARG2

An INTENT(IN) vector of the same type as ARG1.

### Result type and attributes

The result is of the same type as ARG1.

### Result value

The value of each element of the result is the saturated result of subtracting the value of the corresponding element of ARG2 from the value of the corresponding element of ARG1.

---

## VEC\_SUM2S(ARG1, ARG2)

### Purpose

Returns a vector containing the results of performing a sum across 1/2 vector operation on the given vectors.

### Class

Elemental function

### Argument type and attributes

#### ARG1

An INTENT(IN) INTEGER(4) vector.

#### ARG2

An INTENT(IN) vector of the same type as ARG1.

### Result type and attributes

The result is of the same type as ARG1.

### Result value

The first and third element of the result are 0. The second element of the result contains the saturated sum of the first and second elements of ARG1 and the second element of ARG2. The fourth element of the result contains the saturated sum of the third and fourth elements of ARG1 and the fourth element of ARG2.

---

## VEC\_SUM4S(ARG1, ARG2)

### Purpose

Returns a vector containing the results of performing a sum across 1/4 vector operation on the given vectors.

### Class

Elemental function

### Argument type and attributes

#### ARG1

An INTENT(IN) INTEGER(1) vector, INTEGER(2) vector, or UNSIGNED(1) vector.

#### ARG2

An INTENT(IN) vector. If ARG1 is an integer vector, then ARG2 is an INTEGER(4) vector. If ARG1 is an unsigned vector, then ARG2 is an UNSIGNED(4) vector.

### Result type and attributes

The result is a vector of the same type as ARG2.

### Result value

Assume that the elements of each vector are numbered beginning with 0. If ARG1 is an INTEGER(1) vector or an UNSIGNED(1) vector, then let  $m$  be 4. Otherwise, let  $m$  be 2. For each element  $n$  of the result vector, the value is obtained by adding elements  $mn$  through  $mn+m-1$  of ARG1 and element  $n$  of ARG2 using saturated addition.

---

## VEC\_SUMS(ARG1, ARG2)

### Purpose

Returns a vector containing the results of performing a sum across vector operation on the given vectors.

### Class

Elemental function

### Argument type and attributes

#### ARG1

An INTENT(IN) INTEGER(4) vector.

#### ARG2

An INTENT(IN) vector of the same type as ARG1.

### Result type and attributes

The result is a vector of the same type as ARG1.

### Result value

The first three elements of the result are 0. The fourth element is the saturated sum of all the elements of ARG1 and the fourth element of ARG2.

---

## VEC\_TRUNC(ARG1)

### Purpose

Returns a vector containing the truncated values of the corresponding elements of the given vector.

### Class

Elemental function

### Argument type and attributes

**ARG1**

An INTENT(IN) real vector.

### Result type and attributes

The result is a vector of the same type as ARG1.

### Result value

Each element of the result contains the value of the corresponding element of ARG1, truncated to an integral value.

---

## VEC\_UNPACKH(ARG1)

### Purpose

Unpacks the most significant ("high") half of a vector into a vector with larger elements.

### Class

Elemental function

### Argument type and attributes

**ARG1**

An INTENT(IN) INTEGER(1) vector, INTEGER(2) vector, or pixel vector.

### Result type and attributes

If ARG1 is an INTEGER(1) vector, then the result is an INTEGER(2) vector. If ARG1 is an INTEGER(2) vector, then the result is an INTEGER(4) vector. If ARG1 is a pixel vector, then the result is an UNSIGNED(4) vector.

### Result value

If ARG1 is an integer vector, then the value of each element of the result is the value of the corresponding element of the most significant half of ARG1. If ARG1 is a pixel vector, then the value of each element of the result is taken from the corresponding element of the most significant half of ARG1 as follows: all bits in the first byte of the element of the result are set to the value of the first bit of the element of ARG1; the least significant 5 bits of the second byte of the element of the result are set to the value of the next 5 bits in the element of ARG1; the least significant 5 bits of the third byte of the element of the result are set to the value of the next 5 bits in the element of ARG1; the least significant 5 bits of the fourth byte of the element of the result are set to the value of the next 5 bits in the element of ARG1.



---

## VEC\_UNPACKL(ARG1)

### Purpose

Unpacks the least significant ("low") half of a vector into a vector with larger elements.

### Class

Elemental function

### Argument type and attributes

#### ARG1

An INTENT(IN) INTEGER(1) vector, INTEGER(2) vector, or pixel vector.

### Result type and attributes

If ARG1 is an INTEGER(1) vector, then the result is an INTEGER(2) vector. If ARG1 is an INTEGER(2) vector, then the result is an INTEGER(4) vector. If ARG1 is a pixel vector, then the result is an UNSIGNED(4) vector.

### Result value

If ARG1 is an integer vector, then the value of each element of the result is the value of the corresponding element of the least significant half of ARG1. If ARG1 is a pixel vector, then the value of each element of the result is taken from the corresponding element of the least significant half of ARG1 as follows: all bits in the first byte of the element of the result are set to the value of the first bit of the element of ARG1; the least significant 5 bits of the second byte of the element of the result are set to the value of the next 5 bits in the element of ARG1; the least significant 5 bits of the third byte of the element of the result are set to the value of the next 5 bits in the element of ARG1; the least significant 5 bits of the fourth byte of the element of the result are set to the value of the next 5 bits in the element of ARG1.

---

## VEC\_XOR(ARG1, ARG2)

### Purpose

Performs a bitwise XOR of the given vectors.

### Class

Elemental function

### Argument type and attributes

#### ARG1

An INTENT(IN) integer vector, real vector, or unsigned vector.

#### ARG2

An INTENT(IN) vector of the same type as ARG1.

### Result type and attributes

The result is of the same type as ARG1.

## Result value

The result is the bitwise XOR of ARG1 and ARG2.

End of IBM Extension

---

## Chapter 17. Language interoperability features

Fortran 2003

XL Fortran provides a standardized mechanism for interoperating with C based on the Fortran 2003 Standard. An entity is said to be interoperable if equivalent declarations of it can be made in the two languages. XL Fortran enforces interoperability for types, variables, and procedures. Interoperability with the C programming language allows portable access to many libraries and the low-level facilities provided by C and allows the portable use of Fortran libraries by programs written in C. XL The details of this implementation are discussed in this section.

- Intrinsic types
- Derived types
- Variables
- Common blocks
- Procedures
- ISO\_C\_BINDING module
- Binding labels

---

### Interoperability of types

#### Intrinsic types

XL Fortran provides the **ISO\_C\_BINDING** intrinsic module that contains named constants holding kind type parameter values for intrinsic types. Their names are shown together with the corresponding C types in Table 37 on page 746. Only those intrinsic types listed in the table are interoperable; other intrinsic types are not.

#### Derived types

XL Fortran provides the ability to define derived types that correspond to C **struct** types. A Fortran derived type with the **BIND** attribute is interoperable with a C **struct** type if all of the following conditions are met:

- The Fortran derived type definition is given the **BIND(C)** attribute explicitly.
- The Fortran derived type and C **struct** type have the same number of components.
- The components of the Fortran derived type have types and type parameters that are interoperable with the types of the corresponding components of the C **struct** type, and cannot have the **POINTER** or **ALLOCATABLE** attribute.
- The components of the Fortran derived type and of the C **struct** type are declared in the same relative positions in their relative type definitions.

For example, the C type *myctype*, declared below, is interoperable with the Fortran type *myftype*, declared below.

```
typedef struct {  
    int m, n;  
    float r;  
} myctype;
```

```

USE, INTRINSIC :: ISO_C_BINDING
TYPE, BIND(C) :: MYFTYPE
  INTEGER(C_INT) :: I, J
  REAL(C_FLOAT) :: S
END TYPE MYFTYPE

```

Note that the names of the corresponding components of the derived type and the C struct type need not be the same; the names are not significant in determining whether the Fortran derived type and C **struct** type are interoperable.

There is no Fortran type that is interoperable with a C struct type that contains a bit field or that contains a flexible array member. There is no Fortran type that is interoperable with a C union type.

---

## Interoperability of Variables

A Fortran module variable that has the **BIND** attribute may interoperate with a C variable with external linkage.

There need not be an associated C entity for a module variable with the **BIND** attribute.

A scalar Fortran variable is interoperable if its type and type parameters are interoperable and it has neither the **POINTER** nor the **ALLOCATABLE** attributes. An interoperable scalar Fortran variable is interoperable with a scalar C variable if its type and type parameters are interoperable with the type of the C variable.

A Fortran array variable is interoperable, if its type and type parameters are interoperable, it is of explicit shape or assumed size, it is not zero-sized, and it does not have the **POINTER** or **ALLOCATABLE** attributes.

A Fortran array is interoperable with a C array, if its size is nonzero and

- Its rank is equal to one and an element of the array is interoperable with an element of the C array
- Its rank is greater than one and the base types of the two arrays are equivalent and each of the dimensions correspond.

Because C uses row-major arrays and Fortran uses column-major arrays, a C array's dimensions must be the reverse of a Fortran array's dimensions.

---

## Interoperability of common blocks

A C variable with external linkage can interoperate with a common block that has the **BIND** attribute.

If a common block has the **BIND** attribute, it must have the **BIND** attribute and the same binding label in each scoping unit in which it is declared. A C variable with external linkage interoperates with a common block with the **BIND** attribute if:

- The C variable is of a struct type and the variables that are members of the common block are interoperable with corresponding components of the struct type, or
- The common block contains a single variable, and the variable is interoperable with the C variable.

There need not be an associated C entity for a common block with the **BIND** attribute.

---

## Interoperability of procedures

A Fortran procedure is interoperable if its interface is interoperable. A Fortran procedure interface is interoperable if it has the **BIND** attribute. A Fortran procedure interface is interoperable with a C function prototype if:

- The interface has the **BIND** attribute.
- The interface describes a function whose result variable is a scalar that is interoperable with the result of the prototype, or the interface describes a subroutine, and the prototype has a result type of void.
- The number of dummy arguments of the interface is equal to the number of formal parameters of the prototype.
- Any dummy argument with the **VALUE** attribute is interoperable with the corresponding formal parameter of the prototype.
- Any dummy argument without the **VALUE** attribute corresponds to a formal parameter of the prototype that is of a pointer type, and the dummy argument is interoperable with an entity of the referenced type of the formal parameter.
- The prototype does not have variable arguments.

In the following example, the Fortran procedure interface:

```
INTERFACE
  FUNCTION FUNC(I, J, K, L, M) BIND(C)
    USE, INTRINSIC :: ISO_C_BINDING
    INTEGER(C_SHORT) :: FUNC
    INTEGER(C_INT), VALUE :: I
    REAL(C_DOUBLE) :: J
    INTEGER(C_INT) :: K, L(10)
    TYPE(C_PTR), VALUE :: M
  END FUNCTION FUNC
END INTERFACE
```

is interoperable with the C function prototype:

```
short func(int i, double *j, int *k, int l[10], void *m);
```

A C data pointer may correspond to a Fortran dummy argument of type `C_PTR` or to a Fortran scalar that does not have the **VALUE** attribute. In the example, the C pointers *j* and *k* correspond to the Fortran scalars **J** and **K**, respectively. The C pointer *m* corresponds to the Fortran dummy argument **M** of type `C_PTR`.

---

## The ISO\_C\_BINDING module

The `ISO_C_BINDING` module provides access to named constants that represent kind type parameters of data representations compatible with C types, the derived type `C_PTR` corresponding to any C data pointer type, the derived type `C_FUNPTR` corresponding to any C function pointer type, and four procedures.

### Constants for use as kind type parameters

Table 37 on page 746 shows the interoperability between Fortran intrinsic types and C types. A Fortran intrinsic type with particular kind type parameter values is interoperable with a C type if the type and kind type parameter value are listed in the same row as that C type; if the type is character, interoperability also requires that the length type parameter be omitted or be specified by an initialization expression whose value is one. A combination of Fortran type and type parameters that is interoperable with a C type listed in the table is also interoperable with any unqualified C type that is compatible with the listed C type.

Table 37. Interoperable Fortran and C types

Fortran Type	Named Constant (kind type parameter)	Value	C Type
INTEGER	C_SIGNED_CHAR	1	signed char
	C_SHORT	2	short
	C_INT	4	int
	C_LONG	4 (with -q32) 8 (with -q64)	long
	C_LONG_LONG	8	long long
	C_SIZE_T	4 (with -q32) 8 (with -q64)	size_t
	C_INTPTR_T	4 (with -q32) 8 (with -q64)	intptr_t
	C_INTMAX_T	8	intmax_t
	C_INT8_T	1	int8_t
	C_INT16_T	2	int16_t
	C_INT32_T	4	int32_t
	C_INT64_T	8	int64_t
	C_INT_LEAST8_T	1	int_least8_t
	C_INT_LEAST16_T	2	int_least16_t
	C_INT_LEAST32_T	4	int_least32_t
	C_INT_LEAST64_T	8	int_least64_t
	C_INT_FAST8_T	1	int_fast8_t
	C_INT_FAST16_T	4	int_fast16_t
	C_INT_FAST32_T	4	int_fast32_t
	C_INT_FAST64_T	8	int_fast64_t
REAL	C_FLOAT	4	float
	C_DOUBLE	8	double
	C_LONG_DOUBLE	16	long double
	C_FLOAT_COMPLEX	4	float _Complex
	C_DOUBLE_COMPLEX	8	double _Complex
	C_LONG_DOUBLE_COMPLEX	16	long double _Complex
LOGICAL	C_BOOL	1	_Bool
CHARACTER	C_CHAR	1	char

For example, the type integer with a kind type parameter of C\_SHORT is interoperable with the C type short or any C type derived (via typedef) from short.

**Notes:**

1. The named constants in the ISO\_C\_BINDING module are of type INTEGER(4).
2. In order for any Fortran COMPLEX entity to be interoperable with a corresponding C \_Complex entity appearing in C code compiled with gcc, the Fortran code must be compiled with **-qfloat=complexgcc**.
3. Fortran REAL(C\_LONG\_DOUBLE) and COMPLEX(C\_LONG\_DOUBLE\_COMPLEX) entities are only interoperable with the corresponding C types if the C code is compiled with an option that enables 128-bit long doubles.
4. Fortran integer entities with kind type parameter values of C\_LONG\_LONG, C\_INT64\_T, C\_INT\_LEAST64\_T, C\_INT\_FAST64\_T, and C\_INTMAX\_T are only interoperable with the corresponding C types if the C compiler supports long long int types (**-qlonglong** in the XL C/C++ compiler).

## Character constants

The following character constants are provided for compatibility with some commonly used C characters that are represented using escape sequences:

Table 38. Fortran named constants and C characters

Fortran Named Constant	Definition	C Character
C_NULL_CHAR	null character	'\0'
C_ALERT	alert	'\a'
C_BACKSPACE	backspace	'\b'
C_FORM_FEED	form feed	'\f'
C_NEW_LINE	new line	'\n'
C_CARRIAGE_RETURN	carriage return	'\r'
C_HORIZONTAL_TAB	horizontal tab	'\t'
C_VERTICAL_TAB	vertical tab	'\v'

## Other constants

The constant `C_NULL_PTR` is of type `C_PTR`; it has the value of a C null data pointer. The constant `C_NULL_FUNPTR` is of type `C_FUNPTR`; it has the value of a C null function pointer.

## Types

The type `C_PTR` is interoperable with any C data pointer type. The type `C_FUNPTR` is interoperable with any C function pointer type. They are both derived types with private components.

## Procedures

A C procedure argument is often defined in terms of a C address. The `ISO_C_BINDING` module provides the following procedures. The `C_ASSOCIATED` function is provided so that Fortran programs can compare C addresses. The `C_F_POINTER` subroutine provides a means of associating a Fortran pointer with the target of a C pointer. The `C_FUNLOC` and `C_LOC` functions are provided so that Fortran applications can determine the appropriate value to use with C facilities.

### `C_ASSOCIATED(C_PTR_1[, C_PTR_2])`

**Purpose:** Indicates the association status of `C_PTR_1`, or whether `C_PTR_1` and `C_PTR_2` are associated with the same entity.

**Class:** Inquiry function

**Argument type and attributes:**

`C_PTR_1`

Scalar of type `C_PTR` or `C_FUNPTR`.

`C_PTR_2`

An optional scalar of the same type as `C_PTR_1`.

**Result type and attributes:** Default logical

**Result value:**

- If `C_PTR_2` is absent, then the result is false if `C_PTR_1` is a C null pointer; otherwise, it has a value of true.

- If **C\_PTR\_2** is present, then the result is false if **C\_PTR\_1** is a C null pointer. Otherwise, the result is true if **C\_PTR\_1** compares equal to **C\_PTR\_2**, and false otherwise.

## **C\_F\_POINTER(CPTR, FPTR [, SHAPE])**

**Purpose:** Associates a data pointer with the target of a C pointer and specifies its shape.

**Class:** Subroutine

### **Argument type and attributes:**

**CPTR** An **INTENT(IN)** argument; a scalar and of type **C\_PTR**.

**FPTR** An **INTENT(OUT)** argument that is a pointer.

### **SHAPE**

An optional **INTENT(IN)** argument of type integer and rank one. If present, its size equals the rank of **FPTR**. **SHAPE** must be present if and only if **FPTR** is an array.

**Rules:** If the value of **CPTR** is the C address of an interoperable data entity, then:

- **FPTR** has type and type parameters that are interoperable with the type of the entity.
- **FPTR** becomes pointer associated with the target of **CPTR**.
- If **FPTR** is an array, its shape is specified by **SHAPE**, and each lower bound is 1.

Otherwise, the value of **CPTR** will be the result of a reference to **C\_LOC** with a noninteroperable argument **X**. **X** (or its target) cannot have been deallocated or have become undefined due to the execution of a **RETURN** or **END** statement since the reference to **C\_LOC**. **FPTR** is a nonpolymorphic, scalar pointer with the same type and type parameters as **X**. It becomes pointer-associated with **X** (or its target if **X** is a pointer).

## **C\_FUNLOC(X)**

**Purpose:** Returns the C address of a function pointer.

**Class:** Inquiry function

### **Argument type and attributes:**

**X** An interoperable procedure.

**Result type and attributes:** Scalar of type **C\_FUNPTR**

**Result value:** A value of type **C\_FUNPTR** that represents the C address of the argument.

## **C\_LOC(X)**

**Purpose:** Returns the C address of the argument.

**Class:** Inquiry function

### **Argument type and attributes:**

**X** Must be one of the following:



- an interoperable, nonpointer, nonallocatable data variable with the **TARGET** attribute.
- an allocated allocatable data variable with the **TARGET** attribute and interoperable type and type parameters and not a zero-sized array.
- an associated scalar pointer with interoperable type and type parameters.
- a nonallocatable, nonpointer, scalar variable that has the **TARGET** attribute.
- an allocated, nonpolymorphic, allocatable scalar pointer that has the **TARGET** attribute.
- an associated, nonpolymorphic, scalar pointer.

**Result type and attributes:** Scalar of type **C\_PTR**

**Result value:** A value of type **C\_PTR** that represents the C address of the argument.

## Binding labels

A binding label is a value of type default character that specifies the name by which a variable, common block, or a procedure is known to the C compiler.

If a variable, common block, or non-dummy procedure has the **BIND** attribute specified with a **NAME=** specifier, the binding label is the value of the expression specified for the **NAME=** specifier. The case of letters in the binding label is significant, but leading and trailing blanks are ignored. If the entity has the **BIND** attribute specified without a **NAME=** specifier, the binding label is the same as the name of the entity using lower case letters.

The binding label of a C entity with external linkage is the same as the name of the C entity. A Fortran entity with the **BIND** attribute that has the same binding label as a C entity with external linkage is associated with that entity.

A binding label cannot be the same as another binding label or a name used to identify any global entity of the Fortran program, ignoring differences in case except when **-qmixed** (or **-U**) is specified.

End of Fortran 2003



---

## Chapter 18. The ISO\_FORTRAN\_ENV intrinsic module

Fortran 2003

The **ISO\_FORTRAN\_ENV** intrinsic module provides constants relating to the Fortran environment as follows:

- CHARACTER\_STORAGE\_SIZE
- ERROR\_UNIT
- FILE\_STORAGE\_SIZE
- INPUT\_UNIT
- IOSTAT\_END
- IOSTAT\_EOR
- NUMERIC\_STORAGE\_SIZE
- OUTPUT\_UNIT

**Note:** The kind of the constants in this module, and the value of the **NUMERIC\_STORAGE\_SIZE** constant assume a default integer size of 4.

---

### CHARACTER\_STORAGE\_SIZE

#### Purpose

The size, expressed in bits, of the character storage unit.

#### Type

Default integer scalar.

#### Value

8

---

### ERROR\_UNIT

#### Purpose

Identifies the preconnected external unit used for error reporting.

#### Type

Default integer scalar.

#### Value

0

---

### FILE\_STORAGE\_SIZE

#### Purpose

The size, expressed in bits, of the file storage unit.

**Type**

Default integer scalar.

**Value**

8

---

**INPUT\_UNIT****Purpose**

Identifies the preconnected external unit used for input.

**Type**

Default integer scalar.

**Value**

5

---

**IOSTAT\_END****Purpose**

Assigned to the variable specified in an **IOSTAT=** specifier if an end-of-file condition occurs during execution of a **READ** statement. You must set the **IOSTAT\_END=2003std** runtime option to get this value for end-of-file conditions on internal files. (See the **IOSTAT\_END** runtime option in the *XL Fortran Compiler Reference* for more information.)

**Type**

Default integer scalar.

**Value**

-1

---

**IOSTAT\_EOR****Purpose**

Assigned to the variable specified in an **IOSTAT=** specifier if an end-of-record condition occurs during execution of a **READ** statement.

**Type**

Default integer scalar.

**Value**

-4

---

## NUMERIC\_STORAGE\_SIZE

### Purpose

The size, expressed in bits, of the numeric storage unit.

### Type

Default integer scalar.

### Value

32

---

## OUTPUT\_UNIT

### Purpose

Identifies the preconnected external unit used for output.

### Type

Default integer scalar.

### Value

6

End of Fortran 2003



---

## Chapter 19. Floating-point control and inquiry procedures

XL Fortran provides several ways that allow you to query and control the floating-point status and control register of the processor directly. These include:

- **fpgets** and **fpsets** subroutines
- Efficient floating-point control and inquiry procedures
- IEEE floating-point procedures, as specified in the Fortran 2003 Standard

The **fpgets** and **fpsets** subroutines retrieve and set the status of floating-point operations, respectively. Instead of calling operating system routines directly, these subroutines use an array of logicals named **fpstat** to pass information back and forth.

XL Fortran also provides procedures in the `xlf_fp_util` module that allow you to control the floating-point status and control register of the processor directly. These procedures are more efficient than the **fpgets** and **fpsets** subroutines; they are mapped into inlined machine instructions that directly manipulate the floating-point status and control register.

XL Fortran includes the **IEEE\_ARITHMETIC**, **IEEE\_EXCEPTIONS**, and **IEEE\_FEATURES** modules to take advantage of the Fortran 2003 Standard rules for the IEEE floating-point status semantics.

If you use the procedures in this chapter to set the floating-point status and control register you may wish to specify the **-qfloat=fenv** option.

See the **-qfloat=fenv** option in the *XL Fortran Compiler Reference* for more information.

---

### fpgets fpsets

The **fpgets** and **fpsets** subroutines retrieve and set the status of the floating-point operations, respectively. The include file `/usr/include/fpdc.h` contains the data declarations (specification statements) for the two subroutines. The include file `/usr/include/fpdt.h` contains the data initializations (data statements) and must be included in a block data program unit.

**fpgets** retrieves the floating-point process status and stores the result in a logical array called **fpstat**.

**fpsets** sets the floating-point status equal to the logical array **fpstat**.

This array contains logical values that can be used to specify floating-point rounding modes. See **fpgets** and **fpsets** subroutines in the *XL Fortran Optimization and Programming Guide* for examples and information on the elements of the **fpstat** array.

**Note:** The `XLF_FP_UTIL` intrinsic module provides procedures for manipulating the status of floating-point operations that are more efficient than the **fpgets** and **fpsets** subroutines. For more information, see “Efficient floating-point control and inquiry procedures” on page 756.

### Examples

```
CALL fpgets( fpstat )
...
CALL fpsets( fpstat )
BLOCK DATA
INCLUDE 'fpdc.h'
INCLUDE 'fpdt.h'
END
```

---

## Efficient floating-point control and inquiry procedures

XL Fortran provides several procedures that allow you to query and control the floating-point status and control register of the processor directly. These procedures are more efficient than the `fpgets` and `fpsets` subroutines because they are mapped into inlined machine instructions that manipulate the floating-point status and control register (`fpscr`) directly.

XL Fortran supplies the module `xlf_fp_util`, which contains the interfaces and data type definitions for these procedures and the definitions for the named constants that are needed by the procedures. This module enables type checking of these procedures at compile time rather than at link time. You can use the argument names listed in the examples as the names for keyword arguments when calling a procedure. The following files are supplied for the `xlf_fp_util` module:

File names	File type	Locations
<code>xlf_fp_util.mod</code>	module symbol file	<ul style="list-style-type: none"><li><code>/usr/lpp/xlf/include</code></li><li><code>/usr/lpp/xlf/include_d7</code></li></ul> <p><b>Note:</b> The files in these directories are exact copies of one another.</p>

To use these procedures, you must add a `USE XLF_FP_UTIL` statement to your source file. For more information on `USE`, see “`USE`” on page 468.

If there are name conflicts (for example if the accessing subprogram has an entity with the same name as a module entity), use the **ONLY** clause or the renaming features of the `USE` statement. For example,

```
USE XLF_FP_UTIL, NULL1 => get_fpscr, NULL2 => set_fpscr
```

When compiling with the `-U` option, you must code the names of these procedures in all lowercase. We will show the names in lowercase here as a reminder.

The `fpscr` procedures are:

- “`clr_fpscr_flags`” on page 758
- “`fp_trap`” on page 758
- “`get_fpscr`” on page 759
- “`get_fpscr_flags`” on page 759
- “`get_round_mode`” on page 760
- “`set_fpscr`” on page 760
- “`set_fpscr_flags`” on page 760
- “`set_round_mode`” on page 761



The following table lists the constants that are used with the fpscr procedures:

Family	Constant	Description
General	FPSCR_KIND	The kind type parameter for a fpscr flags variable
	FP_MODE_KIND	The kind type parameter for fp_trap arguments and results
IEEE Rounding Modes	FP_RND_RN	Round toward nearest (default)
	FP_RND_RZ	Round toward zero
	FP_RND_RP	Round toward plus infinity
	FP_RND_RM	Round toward minus infinity
	FP_RND_MODE	Used to obtain the rounding mode from an FPSCR flags variable or value
IEEE Exception Enable Flags <b>1</b>	TRP_INEXACT	Enable inexact trap
	TRP_DIV_BY_ZERO	Enable divide-by-zero trap
	TRP_UNDERFLOW	Enable underflow trap
	TRP_OVERFLOW	Enable overflow trap
	TRP_INVALID	Enable invalid trap
	FP_ENBL_SUMM	Trap enable summary or enable all
IEEE Exception Status Flags	FP_INVALID	Invalid operation exception
	FP_OVERFLOW	Overflow exception
	FP_UNDERFLOW	Underflow exception
	FP_DIV_BY_ZERO	Divide-by-zero exception
	FP_INEXACT	Inexact exception
	FP_ALL_IEEE_XCP	All IEEE exceptions summary flags
	FP_COMMON_IEEE_XCP	All IEEE exceptions summary flags excluding the FP_INEXACT exception
Machine Specific Exception Details Flags	FP_INV_SNaN	Signaling NaN
	FP_INV_ISI	Infinity - Infinity
	FP_INV_IDI	Infinity / Infinity
	FP_INV_ZDZ	0 / 0
	FP_INV_IMZ	Infinity * 0
	FP_INV_CMP	Unordered compare
	FP_INV_SQRT	Square root of negative number
	FP_INV_CVI	Conversion to integer error
	FP_INV_VXSOFT	Software request
Machine Specific Exception Summary Flags	FP_ANY_XCP	Any exception summary flag
	FP_ALL_XCP	All exceptions summary flags
	FP_COMMON_XCP	All exceptions summary flags excluding the FP_INEXACT exception

Family	Constant	Description
fp_trap constants <b>2</b>	FP_TRAP_SYNC	Precise trapping on
	FP_TRAP_OFF	Trapping off
	FP_TRAP_QUERY	Query trapping mode
	FP_TRAP_IMP	Non-recoverable imprecise trapping on
	FP_TRAP_IMP_REC	Recoverable imprecise trapping on
	FP_TRAP_FASTMODE	Select fastest available mode
	FP_TRAP_ERROR	Error condition
	FP_TRAP_UNIMPL	Requested mode not available

**Notes:**

1. In order to enable exception trapping, you must set the desired IEEE Exception Enable Flags and,
  - change the mode of the user process to allow floating-point exceptions to generate traps with a call to `fp_trap`, or,
  - compile your program with the appropriate `-qflttrap` suboption. For more information on the `-qflttrap` compiler option and its suboptions, see the *XL Fortran Compiler Reference*.
2. For more information on `fp_trap` constants, see `fp_trap` in *AIX Technical Reference: Base Operating System and Extensions Volume 1*.

## xlf\_fp\_util Floating-Point Procedures

This section lists the efficient floating-point control and inquiry procedures in the `XLF_FP_UTIL` intrinsic module.

### clr\_fpscr\_flags

**Type:** The `clr_fpscr_flags` subroutine clears the floating-point status and control register flags you specify in the `MASK` argument. Flags that you do not specify in `MASK` remain unaffected. `MASK` must be of type `INTEGER(FPSCR_KIND)`. You can manipulate the `MASK` using the intrinsic procedures described in “Integer bit model” on page 531.

For more information on the `FPSCR` constants, see “`FPSCR` constants” on page 757.

**Examples:**

```
USE, INTRINSIC :: XLF_FP_UTIL
INTEGER(FPSCR_KIND) MASK

! Clear the overflow and underflow exception flags

MASK=(IOR(FP_OVERFLOW,FP_UNDERFLOW))
CALL clr_fpscr_flags(MASK)
```

For another example of the `clr_fpscr_flags` subroutine, see “`get_fpscr_flags`” on page 759.

### fp\_trap

**Type:** The `fp_trap` function allows you to query or change the mode of the user process to allow floating-point exceptions to generate traps. The argument `TRAP_MODE` should be an `fp_trap` constant. For information on `fp_trap` constants, see “`FPSCR` constants” on page 757.

For more information, see `fp_trap` in *AIX Technical Reference: Base Operating System and Extensions Volume 1*.

**Result type and attributes:** `fp_trap` returns `INTEGER(FP_MODE_KIND)` in the form of an `fp_trap` constant.

**Result value:** See *AIX Technical Reference: Base Operating System and Extensions Volume 1*.

**Examples:**

```
USE XLF_FP_UTIL
INTEGER(FP_MODE_KIND) FP_MODE, TRAP_MODE

TRAP_MODE = FP_TRAP_IMP
FP_MODE = fp_trap(TRAP_MODE)
```

For another example of how to use `fp_trap`, see “`set_fpscr_flags`” on page 760.

### **get\_fpscr**

**Type:** The `get_fpscr` function returns the current value of the floating-point status and control register (`fpscr`) of the processor.

**Result type and attributes:** `INTEGER(FPSCR_KIND)`

**Result value:** The current value of the floating-point status and control register (`FPSCR`) of the processor.

**Examples:**

```
USE, INTRINSIC :: XLF_FP_UTIL
INTEGER(FPSCR_KIND) FPSCR

FPSCR=get_fpscr()
```

### **get\_fpscr\_flags**

**Type:** The `get_fpscr_flags` function returns the current state of the floating-point status and control register flags you specify in the `MASK` argument. `MASK` must be of type `INTEGER(FPSCR_KIND)`. You can manipulate the `MASK` using the intrinsics described in “Integer bit model” on page 531.

For more information on the `FPSCR` constants, see “`FPSCR constants`” on page 757.

**Result type and attributes:** An `INTEGER(FPSCR_KIND)`

**Result value:** The status of the `FPSCR` flags specified by the `MASK` argument. If a flag specified in the `MASK` argument is on, the value for the flag will be returned in the return value. The following example requests the status of the `FP_DIV_BY_ZERO` and `FP_INVALID` flags.

- If both flags are on, the return value is `IOR(FP_DIV_BY_ZERO, FP_INVALID)`.
- If only the `FP_INVALID` flag is on, the return value is `FP_INVALID`.
- If only the `FP_DIV_BY_ZERO` flag is on, the return value is `FP_DIV_BY_ZERO`.
- If neither flag is on, the return value is 0.

**Examples:**

```
USE, INTRINSIC :: XLF_FP_UTIL

! ...
```

```

IF (get_fpscr_flags(IOR(FP_DIV_BY_ZERO,FP_INVALID)) .NE. 0) THEN
  ! Either Divide-by-zero or an invalid operation occurred.

  ! ...

  ! After processing the exception, the exception flags are
  ! cleared.
  CALL clr_fpscr_flags(IOR(FP_DIV_BY_ZERO,FP_INVALID))
END IF

```

## get\_round\_mode

**Type:** The `get_round_mode` function returns the current floating-point rounding mode. The return value will be one of the constants `FP_RND_RN`, `FP_RND_RZ`, `FP_RND_RP` or `FP_RND_RM`. For more information on the rounding mode constants, see “FPSCR constants” on page 757.

**Result type and attributes:** An `INTEGER(FPSCR_KIND)`

**Result value:** One of the constants `FP_RND_RN`, `FP_RND_RZ`, `FP_RND_RP` or `FP_RND_RM`.

### Examples:

```

USE, INTRINSIC :: XLF_FP_UTIL
INTEGER(FPSCR_KIND) MODE

MODE=get_round_mode()
IF (MODE .EQ. FP_RND_RZ) THEN
  ! ...
END IF

```

## set\_fpscr

**Type:** The `set_fpscr` function sets the floating-point status and control register (`fpscr`) of the processor to the value provided in the `FPSCR` argument, and returns the value of the register before the change.

**Argument type and attributes:** An `INTEGER(FPSCR_KIND)`

**Result type and attributes:** An `INTEGER(FPSCR_KIND)`.

**Result value:** The value of the register before it was set with `set_fpscr`.

### Examples:

```

USE, INTRINSIC :: XLF_FP_UTIL
INTEGER(FPSCR_KIND) FPSCR, OLD_FPSCR

FPSCR=get_fpscr()

! ... Some changes are made to FPSCR ...

OLD_FPSCR=set_fpscr(FPSCR) ! OLD_FPSCR is assigned the value of
                          ! the register before it was
                          ! set with set_fpscr

```

## set\_fpscr\_flags

**Type:** The `set_fpscr_flags` subroutine allows you to set the floating-point status and control register flags you specify in the `MASK` argument. Flags that you do not specify in `MASK` remain unaffected. `MASK` must be of type

INTEGER(FPSCR\_KIND). You can manipulate the MASK using the intrinsics described in “Integer bit model” on page 531.

For more information on the FPSCR constants, see “FPSCR constants” on page 757.

**Examples:**

```
USE XLF_FP_UTIL
INTEGER(FPSCR_KIND) SAVED_FPSCR
INTEGER(FP_MODE_KIND) FP_MODE

SAVED_FPSCR = get_fpscr()           ! Saves the current value of
                                   ! the fpscr register.
FP_MODE = fp_trap(FP_TRAP_SYNC)     ! Enables precise trapping.

CALL set_fpscr_flags(TRP_DIV_BY_ZERO) ! Enables trapping of
! ...                               ! divide-by-zero.
FP_MODE=fp_trap(FP_MODE)           ! Restores initial trap
                                   ! mode.
SAVED_FPSCR=set_fpscr(SAVED_FPSCR) ! Restores fpscr register.
```

**set\_round\_mode**

**Type:** The set\_round\_mode function sets the current floating-point rounding mode, and returns the rounding mode before the change. You can set the mode to FP\_RND\_RN, FP\_RND\_RZ, FP\_RND\_RP or FP\_RND\_RM. For more information on the rounding mode constants, see “FPSCR constants” on page 757.

**Argument type and attributes:** Integer of kind FPSCR\_KIND

**Result type and attributes:** Integer of kind FPSCR\_KIND

**Result value:** The rounding mode before the change.

**Examples:**

```
USE XLF_FP_UTIL
INTEGER(FPSCR_KIND) MODE

MODE=set_round_mode(FP_RND_RZ) ! The rounding mode is set to
                               ! round towards zero. MODE is
! ...                          ! assigned the previous rounding
                               ! mode.
MODE=set_round_mode(MODE)     ! The rounding mode is restored.
```

---

## IEEE Modules and support

---

### Fortran 2003

---

XL Fortran offers support for IEEE floating-point functionality as specified in the Fortran 2003 standard. The standard defines the **IEEE\_EXCEPTIONS** module for exceptions, the **IEEE\_ARITHMETIC** module to support IEEE arithmetic, and **IEEE\_FEATURES** to specify the IEEE features supported by the compiler.

When using the **IEEE\_EXCEPTIONS**, or **IEEE\_ARITHMETIC** intrinsic modules, the XL Fortran compiler enforces several Fortran 2003 rules regarding the scope of changes to the floating-point status concerning rounding mode, halting mode, and exception flags. This can impede the performance of programs that use these modules, but do not utilize the new floating-point status semantics. For such programs, the **-qstrictieemod** compiler option is provided to relax the rules on saving and restoring floating point status.

### Notes:

1. XL Fortran Extended Precision floating-point numbers are not in the format suggested by the IEEE standard. As a result, some parts of the modules do not support **REAL(16)**.
2. Programs using the halting facilities of the IEEE modules must be compiled using **-qflttrap** option. When halting is enabled and an exception occurs, the IEEE modules generate **SIGTRAP** signals. Specifying the **-qflttrap=imprecise** compiler option reduces the performance impact of halting while remaining compliant with the Fortran 2003 requirements.

## Compiling and exception handling

XL Fortran provides a number of options for strict compliance with the IEEE standard.

- Use **-qfloat=nomaf** to ensure compatibility with the IEEE standard for floating point arithmetic (IEEE 754-1985).
- When compiling programs that change the rounding mode, use **-qfloat=rrm**.
- Use **-qfloat=nans** to detect signaling NaN values. Signaling NaN values can only occur if specified in a program.
- Use the **-qstrict** compiler option for strict conformance to the IEEE standard for floating-point arithmetic on programs compiled with an optimization level of **-O3** or higher, **-qhot**, **-qipa**, **-qpdf**, or **-qsmp**.
- Compile programs containing a call to a convert-to-integer operation through assignment or the **INT** intrinsic with the **-qarch=ppc** compiler option, or the appropriate **-qarch** suboption for your PowerPC hardware. Specifying an appropriate **-qarch** compiler suboption allows the **IEEE\_INVALID** exception to signal on invalid convert-to-integer operations on the PowerPC platform.
- Compile programs containing calls to **SQRT** with the **-qarch** suboption appropriate to your PowerPC hardware. This allows the **IEEE\_INVALID** exception to signal on invalid **SQRT** operations. If your hardware does not implement the **sqrt** instruction set, or if you want to specify a **-qarch** suboption that includes architectures that do not implement the **sqrt** instruction set, you can still get the **IEEE\_INVALID** exception to signal on invalid **SQRT** operations on AIX 5.1 and above by specifying the following command before you run your program:  

```
export SQRT_EXCEPTION=3.1
```

**Note:** Note: See the **-qarch** option for a list of supported architectures implementing the **sqrt** instruction set.

- Invalid convert-to-integer and square root operations will not set the **IEEE\_INVALID** exception flag on POWER™ platforms.

### Related information

For more information on IEEE floating-point and specific explanations of the compiler options listed above, see Implementation details of XL Fortran floating-point processing in the *XL Fortran Optimization and Programming Guide*.

## General rules for implementing IEEE modules

The **IEEE\_ARITHMETIC**, **IEEE\_EXCEPTIONS**, and **IEEE\_FEATURES** modules are intrinsic, though the types and procedures defined in these modules are not intrinsic.

All functions contained in IEEE modules are pure.

All procedure names are generic and not specific.

The default value for all exception flags is quiet.

By default, exceptions do not cause halting.

Rounding mode defaults towards nearest.

## IEEE Derived data types and constants

The IEEE modules define the following derived types.

### IEEE\_FLAG\_TYPE

**Type:** A derived data type defined by the **IEEE\_EXCEPTIONS** module that identifies a particular exception flag. The values for **IEEE\_FLAG\_TYPE** must be one of the following named constants as defined in the **IEEE\_EXCEPTIONS** module:

#### IEEE\_OVERFLOW

Occurs when the result for an intrinsic real operation or an assignment has an exponent too large to be represented. This exception also occurs when the real or imaginary part of the result for an intrinsic complex operation or assignment has an exponent too large to be represented.

When using **REAL(4)**, an overflow occurs when the result value's unbiased exponent is  $> 127$  or  $< -126$ .

When using **REAL(8)**, an overflow occurs when the result value's unbiased exponent is  $> 1023$  or  $< -1022$ .

#### IEEE\_DIVIDE\_BY\_ZERO

Occurs when a real or complex division has a nonzero numerator and a zero denominator.

#### IEEE\_INVALID

Occurs when a real or complex operation or assignment is invalid.

#### IEEE\_UNDERFLOW

Occurs when the result for an intrinsic real operation or assignment has an absolute value too small to be represented by anything other than zero, and loss of accuracy is detected. The exception also occurs when the real or imaginary part of the result for an intrinsic complex operation or assignment has an absolute value that is too small to be represented by anything other than zero, and loss of accuracy is detected.

For **REAL(4)**, an underflow occurs when the result has an absolute value  $< 2^{-149}$ .

For **REAL(8)**, an underflow occurs when the result has an absolute value  $< 2^{-1074}$ .

#### IEEE\_INEXACT

Occurs when the result of a real or complex assignment or operation is not exact.

The following constants are arrays of **IEEE\_FLAG\_TYPE**:

#### IEEE\_USUAL

An array named constant containing **IEEE\_OVERFLOW**, **IEEE\_DIVIDE\_BY\_ZERO**, and **IEEE\_INVALID** elements in order.

## IEEE\_ALL

An array named constant containing `IEEE_USUAL`, `IEEE_UNDERFLOW`, and `IEEE_INEXACT` elements in order.

## IEEE\_STATUS\_TYPE

**Type:** A derived data type defined in the `IEEE_ARITHMETIC` module that represents the current floating-point status. The floating-point status encompasses the values of all exception flags, halting, and rounding modes.

## IEEE\_CLASS\_TYPE

**Type:** A derived data type defined in the `IEEE_ARITHMETIC` module that categorizes a class of floating-point values. The values for `IEEE_CLASS_TYPE` must be one of the following named constants as defined in the `IEEE_ARITHMETIC` module:

<code>IEEE_SIGNALING_NAN</code>	<code>IEEE_NEGATIVE_ZERO</code>
<code>IEEE_QUIET_NAN</code>	<code>IEEE_POSITIVE_ZERO</code>
<code>IEEE_NEGATIVE_INF</code>	<code>IEEE_POSITIVE_DENORMAL</code>
<code>IEEE_NEGATIVE_NORMAL</code>	<code>IEEE_POSITIVE_NORMAL</code>
<code>IEEE_NEGATIVE_DENORMAL</code>	<code>IEEE_POSITIVE_INF</code>

## IEEE\_ROUND\_TYPE

**Type:** A derived data type defined in the `IEEE_ARITHMETIC` module that identifies a particular rounding mode. The values for `IEEE_ROUND_TYPE` must be one of the following named constants as defined in the `IEEE_ARITHMETIC` module:

### IEEE\_NEAREST

Rounds the exact result to the nearest representable value.

### IEEE\_TO\_ZERO

Rounds the exact result to the next representable value, towards zero.

### IEEE\_UP

Rounds the exact result to the next representable value, towards positive infinity.

### IEEE\_DOWN

Rounds the exact result to the next representable value, towards negative infinity.

### IEEE\_OTHER

Indicates that the rounding mode does not conform to the IEEE standard.

## IEEE\_FEATURES\_TYPE

**Type:** A derived data type defined in the `IEEE_FEATURES` module that identifies the IEEE features to use. The values for `IEEE_FEATURES_TYPE` must be one of the following named constants as defined in the `IEEE_FEATURES` module:

<code>IEEE_DATATYPE</code>	<code>IEEE_DATATYPE</code>
<code>IEEE_DENORMAL</code>	<code>IEEE_INVALID_FLAG</code>
<code>IEEE_DIVIDE</code>	<code>IEEE_NAN</code>
<code>IEEE_HALTING</code>	<code>IEEE_ROUNDING</code>



IEEE_INEXACT_FLAG	IEEE_SQRT
IEEE_INF	IEEE_UNDERFLOW_FLAG

## IEEE Operators

The `IEEE_ARITHMETIC` module defines two sets of elemental operators for comparing variables of `IEEE_CLASS_TYPE` or `IEEE_ROUND_TYPE`.

- `==` Allows you to compare two `IEEE_CLASS_TYPE` or two `IEEE_ROUND_TYPE` values. The operator returns true if the values are identical or false if they differ.
- `/=` Allows you to compare two `IEEE_CLASS_TYPE` or two `IEEE_ROUND_TYPE` values. The operator returns true if the values differ or false if they are identical.

## IEEE PROCEDURES

To use the following IEEE procedures, you must add a `USE IEEE_ARITHMETIC`, `USE IEEE_EXCEPTIONS`, or `USE IEEE_FEATURES` statement to your source file as required. For more information on the `USE` statement, see “`USE`” on page 468.

### Rules for Using IEEE Procedures

**Type:** XL Fortran supports all the named constants in the `IEEE_FEATURES` module.

The `IEEE_ARITHMETIC` module behaves as if it contained a `USE` statement for `IEEE_EXCEPTIONS`. All values that are public in `IEEE_EXCEPTIONS` remain public in `IEEE_ARITHMETIC`.

When the `IEEE_EXCEPTIONS` or the `IEEE_ARITHMETIC` modules are accessible, `IEEE_OVERFLOW` and `IEEE_DIVIDE_BY_ZERO` are supported in the scoping unit for all kinds of real and complex data. To determine the other exceptions supported use the `IEEE_SUPPORT_FLAG` function. Use `IEEE_SUPPORT_HALTING` to determine if halting is supported. Support of other exceptions is influenced by the accessibility of the named constants `IEEE_INEXACT_FLAG`, `IEEE_INVALID_FLAG`, and `IEEE_UNDERFLOW_FLAG` of the `IEEE_FEATURES` module as follows:

- If a scoping unit has access to `IEEE_UNDERFLOW_FLAG` of `IEEE_FEATURES`, the scoping unit supports underflow and returns true from `IEEE_SUPPORT_FLAG(IEEE_UNDERFLOW, X)`, for `REAL(4)` and `REAL(8)`.
- If `IEEE_INEXACT_FLAG` or `IEEE_INVALID_FLAG` is accessible, the scoping unit supports the exception and returns true from the corresponding inquiry for `REAL(4)` and `REAL(8)`.
- If `IEEE_HALTING` is accessible, the scoping unit supports halting control and returns true from `IEEE_SUPPORT_HALTING(FLAG)` for the flag.

If an exception flag signals on entry to a scoping unit that does not access `IEEE_EXCEPTIONS` or `IEEE_ARITHMETIC`, the compiler ensures that the exception flag is signaling on exit. If a flag is quiet on entry to such a scoping unit, it can be signaling on exit.

Further IEEE support is available through the `IEEE_ARITHMETIC` module. Support is influenced by the accessibility of named constants in the `IEEE_FEATURES` module:

- If a scoping unit has access to `IEEE_DATATYPE` of `IEEE_FEATURES`, the scoping unit supports IEEE arithmetic and returns true from `IEEE_SUPPORT_DATATYPE(X)` for `REAL(4)` and `REAL(8)`.
- If `IEEE_DENORMAL`, `IEEE_DIVIDE`, `IEEE_INF`, `IEEE_NAN`, `IEEE_ROUNDING`, or `IEEE_SQRT` is accessible, the scoping unit supports the feature and returns true from the corresponding inquiry function for `REAL(4)` and `REAL(8)`.
- For `IEEE_ROUNDING`, the scoping unit returns true for all the rounding modes `IEEE_NEAREST`, `IEEE_TO_ZERO`, `IEEE_UP`, and `IEEE_DOWN` for `REAL(4)` and `REAL(8)`.

If the `IEEE_EXCEPTIONS` or `IEEE_ARITHMETIC` modules are accessed, and `IEEE_FEATURES` is not, the supported subset of features is the same as if `IEEE_FEATURES` was accessed.

### **IEEE\_CLASS(X)**

**Type:** An elemental IEEE class function. Returns the IEEE class of a floating-point value.

**Module:** `IEEE_ARITHMETIC`

**Syntax:** Where `X` is of type real.

**Result type and attributes:** The result is of type `IEEE_CLASS_TYPE`.

**Rules:** To ensure compliance with the Fortran 2003 standard, the `IEEE_SUPPORT_DATATYPE(X)` function must return with a value of true. If you specify a data type of `REAL(16)`, then `IEEE_SUPPORT_DATATYPE` will return false, though the appropriate class type will still be returned.

#### **Examples:**

```
USE, INTRINSIC :: IEEE_ARITHMETIC
TYPE(IEEE_CLASS_TYPE) :: C
REAL :: X = -1.0
IF (IEEE_SUPPORT_DATATYPE(X)) THEN
  C = IEEE_CLASS(X)           ! C has class IEEE_NEGATIVE_NORMAL
ENDIF
```

### **IEEE\_COPY\_SIGN(X, Y)**

**Type:** An elemental IEEE copy sign function. Returns the value of `X` with the sign of `Y`.

**Module:** `IEEE_ARITHMETIC`

**Syntax:** Where `X` and `Y` are of type real, though they may be of different kinds.

**Result type and attributes:** The result is of the same kind and type as `X`.

**Rules:** To ensure compliance with the Fortran 2003 standard, the `IEEE_SUPPORT_DATATYPE(X)` and `IEEE_SUPPORT_DATATYPE(Y)` must return with a value of true.

For supported IEEE special values, such as NaN and infinity, `IEEE_COPY_SIGN` returns the value of `X` with the sign of `Y`.

`IEEE_COPY_SIGN` ignores the `-qxlf90=nosignedzero` compiler option.

**Note:** XL Fortran **REAL(16)** numbers have no signed zero.

**Examples: Example 1:**

```
USE, INTRINSIC :: IEEE_ARITHMETIC
REAL :: X
DOUBLE PRECISION :: Y
X = 3.0
Y = -2.0
IF (IEEE_SUPPORT_DATATYPE(X) .AND. IEEE_SUPPORT_DATATYPE(Y)) THEN
  X = IEEE_COPY_SIGN(X,Y)           ! X has value -3.0
ENDIF
```

**Example 2:**

```
USE, INTRINSIC :: IEEE_ARITHMETIC
REAL :: X, Y
Y = 1.0
IF (IEEE_SUPPORT_DATATYPE(X)) THEN
  X = IEEE_VALUE(X, IEEE_NEGATIVE_INF) ! X has value -inf
  X = IEEE_COPY_SIGN(X,Y)             ! X has value +inf
ENDIF
```

## **IEEE\_GET\_FLAG(FLAG, FLAG\_VALUE)**

**Type:** An elemental IEEE subroutine. Retrieves the status of the exception flag specified. Sets *FLAG\_VALUE* to true if the flag is signaling, or false otherwise.

**Module:** IEEE\_ARITHMETIC

**Syntax:** Where *FLAG* is an **INTENT(IN)** argument of type **IEEE\_FLAG\_TYPE** specifying the IEEE flag to obtain. *FLAG\_VALUE* is an **INTENT(OUT)** default logical argument that contains the value of *FLAG*.

**Examples:**

```
USE, INTRINSIC:: IEEE_EXCEPTIONS
LOGICAL :: FLAG_VALUE
CALL IEEE_GET_FLAG(IEEE_OVERFLOW,FLAG_VALUE)
IF (FLAG_VALUE) THEN
  PRINT *, "Overflow flag is signaling."
ELSE
  PRINT *, "Overflow flag is quiet."
ENDIF
```

## **IEEE\_GET\_HALTING\_MODE(FLAG, HALTING)**

**Type:** An elemental IEEE subroutine. Retrieves the halting mode for an exception and sets *HALTING* to true if the exception specified by the flag will cause halting. If you use `-qfltrap=imprecise`, halting is not precise and may occur after the exception. By default, exceptions do not cause halting in XL Fortran.

**Module:** IEEE\_ARITHMETIC

**Syntax:** Where *FLAG* is an **INTENT(IN)** argument of type **IEEE\_FLAG\_TYPE** specifying the IEEE flag. *HALTING* is an **INTENT(OUT)** default logical.

**Examples:**

```
USE, INTRINSIC :: IEEE_EXCEPTIONS
LOGICAL HALTING
CALL IEEE_GET_HALTING_MODE(IEEE_OVERFLOW,HALTING)
IF (HALTING) THEN
  PRINT *, "The program will halt on an overflow exception."
ENDIF
```

## IEEE\_GET\_ROUNDING\_MODE (ROUND\_VALUE)

**Type:** An IEEE subroutine. Sets *ROUND\_VALUE* to the current IEEE rounding mode.

**Module:** IEEE\_ARITHMETIC

**Syntax:** Where *ROUND\_VALUE* is an **INTENT(OUT)** scalar of type **IEEE\_ROUND\_TYPE**.

**Examples:**

```
USE, INTRINSIC :: IEEE_ARITHMETIC
TYPE(IEEE_ROUND_TYPE) ROUND_VALUE
CALL IEEE_GET_ROUNDING_MODE(ROUND_VALUE) ! Store the rounding mode
IF (ROUND_VALUE == IEEE_OTHER) THEN
  PRINT *, "You are not using an IEEE rounding mode."
ENDIF
```

## IEEE\_GET\_STATUS(STATUS\_VALUE)

**Type:** An IEEE subroutine. Retrieves the current IEEE floating-point status.

**Module:** IEEE\_ARITHMETIC

**Syntax:** Where *STATUS\_VALUE* is an **INTENT(OUT)** scalar of type **IEEE\_STATUS\_TYPE**.

**Rules:** You can only use *STATUS\_VALUE* in an **IEEE\_SET\_STATUS** invocation.

**Examples:**

```
USE, INTRINSIC :: IEEE_ARITHMETIC
TYPE(IEEE_STATUS_TYPE) STATUS_VALUE
...
CALL IEEE_GET_STATUS(STATUS_VALUE) ! Get status of all exception flags
CALL IEEE_SET_FLAG(IEEE_ALL,.FALSE.) ! Set all exception flags to quiet
... ! calculation involving exception handling
CALL IEEE_SET_STATUS(STATUS_VALUE) ! Restore the flags
```

## IEEE\_IS\_FINITE(X)

**Type:** An elemental IEEE function. Tests whether a value is finite. Returns true if **IEEE\_CLASS(X)** has one of the following values:

- **IEEE\_NEGATIVE\_NORMAL**
- **IEEE\_NEGATIVE\_DENORMAL**
- **IEEE\_NEGATIVE\_ZERO**
- **IEEE\_POSITIVE\_ZERO**
- **IEEE\_POSITIVE\_DENORMAL**
- **IEEE\_POSITIVE\_NORMAL**

It returns false otherwise.

**Module:** IEEE\_ARITHMETIC

**Syntax:** Where *X* is of type real.

**Result type and attributes:** Where the result is of type default logical.

**Rules:** To ensure compliance with the Fortran 2003 standard, the `IEEE_SUPPORT_DATATYPE(X)` must return with a value of true.

**Examples:**

```
USE, INTRINSIC :: IEEE_ARITHMETIC
REAL :: X = 1.0
IF (IEEE_SUPPORT_DATATYPE(X)) THEN
  PRINT *, IEEE_IS_FINITE(X)    ! Prints true
ENDIF
```

### **IEEE\_IS\_NAN(X)**

**Type:** An elemental IEEE function. Tests whether a value is IEEE Not-a-Number. Returns true if `IEEE_CLASS(X)` has the value `IEEE_SIGNALING_NAN` or `IEEE_QUIET_NAN`. It returns false otherwise.

**Module:** `IEEE_ARITHMETIC`

**Syntax:** Where `X` is of type real.

**Result type and attributes:** Where the result is of type default logical.

**Rules:** To ensure compliance with the Fortran 2003 standard, the `IEEE_SUPPORT_DATATYPE(X)` and `IEEE_SUPPORT_NAN(X)` must return with a value of true.

**Examples: Example 1:**

```
USE, INTRINSIC :: IEEE_ARITHMETIC
REAL :: X = -1.0
IF (IEEE_SUPPORT_DATATYPE(X)) THEN
  IF (IEEE_SUPPORT_SQRT(X)) THEN    ! IEEE-compliant SQRT function
    IF (IEEE_SUPPORT_NAN(X)) THEN
      PRINT *, IEEE_IS_NAN(SQRT(X)) ! Prints true
    ENDIF
  ENDIF
ENDIF
```

**Example 2:**

```
USE, INTRINSIC :: IEEE_ARITHMETIC
REAL :: X = -1.0
IF (IEEE_SUPPORT_STANDARD(X)) THEN
  PRINT *, IEEE_IS_NAN(SQRT(X))    ! Prints true
ENDIF
```

### **IEEE\_IS\_NEGATIVE(X)**

**Type:** An elemental IEEE function. Tests whether a value is negative. Returns true if `IEEE_CLASS(X)` has one of the following values:

- `IEEE_NEGATIVE_NORMAL`
- `IEEE_NEGATIVE_DENORMAL`
- `IEEE_NEGATIVE_ZERO`
- `IEEE_NEGATIVE_INF`

It returns false otherwise.

**Module:** `IEEE_ARITHMETIC`

**Syntax:** Where `X` is of type real.

**Result type and attributes:** Where the result is of type default logical.

**Rules:** To ensure compliance with the Fortran 2003 standard, the `IEEE_SUPPORT_DATATYPE(X)` must return with a value of true.

**Examples:**

```
USE, INTRINSIC :: IEEE_ARITHMETIC
IF (IEEE_SUPPORT_DATATYPE(1.0)) THEN
  PRINT *, IEEE_IS_NEGATIVE(1.0) ! Prints false
ENDIF
```

## **IEEE\_IS\_NORMAL(X)**

**Type:** An elemental IEEE function. Tests whether a value is normal. Returns true if `IEEE_CLASS(X)` has one of the following values:

- `IEEE_NEGATIVE_NORMAL`
- `IEEE_NEGATIVE_ZERO`
- `IEEE_POSITIVE_ZERO`
- `IEEE_POSITIVE_NORMAL`

It returns false otherwise.

**Module:** `IEEE_ARITHMETIC`

**Syntax:** Where `X` is of type real.

**Result type and attributes:** Where the result is of type default logical.

**Rules:** To ensure compliance with the Fortran 2003 standard, the `IEEE_SUPPORT_DATATYPE(X)` must return with a value of true.

**Examples:**

```
USE, INTRINSIC :: IEEE_ARITHMETIC
REAL :: X = -1.0
IF (IEEE_SUPPORT_DATATYPE(X)) THEN
  IF (IEEE_SUPPORT_SQRT(X)) THEN ! IEEE-compliant SQRT function
    PRINT *, IEEE_IS_NORMAL(SQRT(X)) ! Prints false
  ENDIF
ENDIF
```

## **IEEE\_LOGB(X)**

**Type:** An elemental IEEE function. Returns unbiased exponent in the IEEE floating-point format. If the value of `X` is neither zero, infinity, or NaN, the result has the value of the unbiased exponent of `X`, equal to `EXPONENT(X)-1`.

**Module:** `IEEE_ARITHMETIC`

**Syntax:** Where `X` is of type real.

**Result type and attributes:** Where the result is the same type and kind as `X`.

**Rules:** To ensure compliance with the Fortran 2003 standard, the `IEEE_SUPPORT_DATATYPE(X)` must return with a value of true.

If `X` is zero, the result is negative infinity.

If `X` is infinite, the result is positive infinity.

If  $X$  is NaN, the result is nan.

**Examples:**

```
USE, INTRINSIC :: IEEE_ARITHMETIC
IF (IEEE_SUPPORT_DATATYPE(1.1)) THEN
  PRINT *, IEEE_LOGB(1.1) ! Prints 0.0
ENDIF
```

### IEEE\_NEXT\_AFTER(X, Y)

**Type:** An elemental IEEE function. Returns the next machine-representable neighbor of  $X$  in the direction towards  $Y$ .

**Module:** IEEE\_ARITHMETIC

**Syntax:** Where  $X$  and  $Y$  are of type real.

**Result type and attributes:** Where the result is the same type and kind as  $X$ .

**Rules:** To ensure compliance with the Fortran 2003 standard, the **IEEE\_SUPPORT\_DATATYPE(X)** and **IEEE\_SUPPORT\_DATATYPE(Y)** must return with a value of true.

If  $X$  and  $Y$  are equal the function returns  $X$  without signaling an exception. If  $X$  and  $Y$  are not equal, the function returns the next machine-representable neighbor of  $X$  in the direction towards  $Y$ .

The neighbors of zero, of either sign, are both nonzero.

**IEEE\_OVERFLOW** and **IEEE\_INEXACT** are signaled when  $X$  is finite but **IEEE\_NEXT\_AFTER(X, Y)** is infinite.

**IEEE\_UNDERFLOW** and **IEEE\_INEXACT** are signaled when **IEEE\_NEXT\_AFTER(X, Y)** is denormalized or zero.

If  $X$  or  $Y$  is a quiet NaN, the result is one of the input NaN values.

**Examples: Example 1:**

```
USE, INTRINSIC :: IEEE_ARITHMETIC
REAL :: X = 1.0, Y = 2.0
IF (IEEE_SUPPORT_DATATYPE(X)) THEN
  PRINT *, (IEEE_NEXT_AFTER(X,Y) == X + EPSILON(X)) ! Prints true
ENDIF
```

**Example 2:**

```
USE, INTRINSIC :: IEEE_ARITHMETIC
REAL(4) :: X = 0.0, Y = 1.0
IF (IEEE_SUPPORT_DATATYPE(X)) THEN
  PRINT *, (IEEE_NEXT_AFTER(X,Y) == 2.0**(-149)) ! Prints true
ENDIF
```

### IEEE\_REM(X, Y)

**Type:** An elemental IEEE remainder function. The result value, regardless of the rounding mode, is exactly  $X - Y * N$ , where  $N$  is the integer nearest to the exact value  $X/Y$ ; whenever  $|N - X/Y| = 1/2$ ,  $N$  is even.

**Module:** IEEE\_ARITHMETIC

**Syntax:** Where  $X$  and  $Y$  are of type real.

**Result type and attributes:** Where the result is of type real with the same kind as the argument with greater precision.

**Rules:** To ensure compliance with the Fortran 2003 standard, the `IEEE_SUPPORT_DATATYPE(X)` and `IEEE_SUPPORT_DATATYPE(Y)` must return with a value of true.

If the result value is zero, the sign is the same as  $X$ .

**Examples:**

```
USE, INTRINSIC :: IEEE_ARITHMETIC
IF (IEEE_SUPPORT_DATATYPE(4.0)) THEN
  PRINT *, IEEE_REM(4.0,3.0) ! Prints 1.0
  PRINT *, IEEE_REM(3.0,2.0) ! Prints -1.0
  PRINT *, IEEE_REM(5.0,2.0) ! Prints 1.0
ENDIF
```

### **IEEE\_RINT(X)**

**Type:** An elemental IEEE function. Rounds to an integer value according to the current rounding mode.

**Module:** `IEEE_ARITHMETIC`

**Syntax:** Where  $X$  is of type real.

**Result type and attributes:** Where the result is the same type and kind as  $X$ .

**Rules:** To ensure compliance with the Fortran 2003 standard, the `IEEE_SUPPORT_DATATYPE(X)` must return with a value of true.

If the result has the value zero, the sign is that of  $X$ .

**Examples:**

```
USE, INTRINSIC :: IEEE_ARITHMETIC
IF (IEEE_SUPPORT_DATATYPE(1.1)) THEN
  CALL IEEE_SET_ROUNDING_MODE(IEEE_NEAREST)
  PRINT *, IEEE_RINT(1.1) ! Prints 1.0
  CALL IEEE_SET_ROUNDING_MODE(IEEE_UP)
  PRINT *, IEEE_RINT(1.1) ! Prints 2.0
ENDIF
```

### **IEEE\_SCALB(X, I)**

**Type:** An elemental IEEE function. Returns  $X * 2^I$ .

**Module:** `IEEE_ARITHMETIC`

**Syntax:** Where  $X$  is of type real and  $I$  is of type `INTEGER`.

**Result type and attributes:** Where the result is the same type and kind as  $X$ .

**Rules:** To ensure compliance with the Fortran 2003 standard, the `IEEE_SUPPORT_DATATYPE(X)` must return with a value of true.

If  $X * 2^I$  is representable as a normal number, then the result is a normal number.



If  $X$  is finite and  $X * 2^I$  is too large the **IEEE\_OVERFLOW** exception occurs. The result value is infinity with the sign of  $X$ .

If  $X * 2^I$  is too small and there is a loss of accuracy, the **IEEE\_UNDERFLOW** exception occurs. The result is the nearest representable number with the sign of  $X$ .

If  $X$  is infinite, the result is the same as  $X$  with no exception signals.

**Examples:**

```
USE, INTRINSIC :: IEEE_ARITHMETIC
IF (IEEE_SUPPORT_DATATYPE(1.0)) THEN
  PRINT *, IEEE_SCALB(1.0,2)      ! Prints 4.0
ENDIF
```

### **IEEE\_SELECTED\_REAL\_KIND([P, R])**

**Type:** A transformational IEEE function. Returns a value of the kind type parameter of an IEEE real data type with decimal precision of at least  $P$  digits, and a decimal exponent range of at least  $R$ .

**Module:** **IEEE\_ARITHMETIC**

**Syntax:** Where  $P$  and  $R$  are both scalar optional arguments of type integer. At least one argument must be present.

**Rules:** If the kind type parameter is not available and the precision is not available, the result is  $-1$ . If the kind type parameter is not available and the exponent range is not available, the result is  $-2$ . If the kind type parameter is not available and if neither the precision or the exponent range is available, the result is  $-3$ .

If more than one kind type parameter value is applicable, the value returned is the one with the smallest decimal precision. If there are several values, the smallest of these kind values is returned.

**Examples:**

```
USE, INTRINSIC :: IEEE_ARITHMETIC

! P and R fit in a real(4)
PRINT *, IEEE_SELECTED_REAL_KIND(6,37)  ! prints 4

! P needs at least a real(8)
PRINT *, IEEE_SELECTED_REAL_KIND(14,37) ! prints 8
! R needs at least a real(8)
PRINT *, IEEE_SELECTED_REAL_KIND(6,307) ! prints 8

! P is too large
PRINT *, IEEE_SELECTED_REAL_KIND(40,37) ! prints -1
! R is too large
PRINT *, IEEE_SELECTED_REAL_KIND(6,400) ! prints -2
! P and R are both too large
PRINT *, IEEE_SELECTED_REAL_KIND(40,400) ! prints -3

END
```

### **IEEE\_SET\_FLAG(FLAGS, FLAG\_VALUE)**

**Type:** An IEEE subroutine. Assigns a value to an IEEE exception flag.

**Module:** **IEEE\_EXCEPTIONS**

**Syntax:** Where *FLAG* is an **INTENT(IN)** scalar or array argument of type **IEEE\_FLAG\_TYPE** corresponding to the value of the flag to be set. *FLAG\_VALUE* is an **INTENT(IN)** scalar or array argument of type logical, corresponding to the desired status of the exception flag. The value of *FLAG\_VALUE* should be conformable with the value of *FLAG*.

**Rules:** If *FLAG\_VALUE* is true, the exception flag specified by *FLAG* is set to signaling. Otherwise, the flag is set to quiet.

Each element of *FLAG* must have a unique value.

**Examples:**

```
USE, INTRINSIC :: IEEE_EXCEPTIONS
CALL IEEE_SET_FLAG(IEEE_OVERFLOW, .TRUE.)
! IEEE_OVERFLOW is now signaling
```

### **IEEE\_SET\_HALTING\_MODE(FLAG, HALTING)**

**Type:** An IEEE subroutine. Controls continuation or halting after an exception.

**Module:** **IEEE\_EXCEPTIONS**

**Syntax:** Where *FLAG* is an **INTENT(IN)** scalar or array argument of type **IEEE\_FLAG\_TYPE** corresponding to the exception flag for which holding applies. *HALTING* is an **INTENT(IN)** scalar or array argument of type logical, corresponding to the desired halting status. By default exceptions will not cause halting in XL Fortran. The value of *HALTING* should be conformable with the value of *FLAG*.

**Rules:** To ensure compliance with the Fortran 2003 standard, the **IEEE\_SUPPORT\_DATATYPE(X)** must return with a value of true.

If you use the **-qflttrap=imprecise** compiler option, halting is not precise and may occur after the exception has occurred.

If *HALTING* is true, the exception specified by *FLAG* will cause halting. Otherwise, execution will continue after the exception.

If your code sets the halting mode to true for an exception flag and you do not use the **-qflttrap=enable** option when compiling the entire program, the program will produce unexpected results if exceptions occur. See the *XL Fortran Compiler Reference* for further information.

Each element of *FLAG* must have a unique value.

**Examples:**

```
@PROCESS FLOAT(NOFOLD)
USE, INTRINSIC :: IEEE_EXCEPTIONS
REAL :: X
CALL IEEE_SET_HALTING_MODE(IEEE_DIVIDE_BY_ZERO, .TRUE.)
X = 1.0 / 0.0
! Program will halt with a divide-by-zero exception
```

### **IEEE\_SET\_ROUNDING\_MODE(ROUND\_VALUE)**

**Type:** An IEEE subroutine. Sets the current rounding mode.

**Module:** **IEEE\_ARITHMETIC**

**Syntax:** Where *ROUND\_VALUE* is an **INTENT(IN)** argument of type **IEEE\_ROUND\_TYPE** specifying the rounding mode.

**Rules:** To ensure compliance with the Fortran 2003 standard, the **IEEE\_SUPPORT\_DATATYPE(X)** and **IEEE\_SUPPORT\_ROUNDING(ROUND\_VALUE, X)** must return with a value of true.

The compilation unit calling this program must be compiled with the **-qfloat=rrm** compiler option.

All compilation units calling programs compiled with the **-qfloat=rrm** compiler option must also be compiled with this option.

**Examples:**

```
USE, INTRINSIC :: IEEE_ARITHMETIC
IF (IEEE_SUPPORT_DATATYPE(1.1)) THEN
  CALL IEEE_SET_ROUNDING_MODE(IEEE_NEAREST)
  PRINT *, IEEE_RINT(1.1)      ! Prints 1.0
  CALL IEEE_SET_ROUNDING_MODE(IEEE_UP)
  PRINT *, IEEE_RINT(1.1)    ! Prints 2.0
ENDIF
```

### **IEEE\_SET\_STATUS(STATUS\_VALUE)**

**Type:** An IEEE subroutine. Restores the value of the floating-point status.

**Module:** **IEEE\_ARITHMETIC**

**Syntax:** Where *STATUS\_VALUE* is an **INTENT(IN)** argument of type **IEEE\_STATUS\_TYPE** specifying the floating-point status.

**Rules:** *STATUS\_VALUE* must have been set previously by **IEEE\_GET\_STATUS**.

### **IEEE\_SUPPORT\_DATATYPE or IEEE\_SUPPORT\_DATATYPE(X)**

**Type:** An inquiry IEEE function. Determines whether the current implementation supports IEEE arithmetic. Support means using an IEEE data format and performing the binary operations of +, -, and \* as in the IEEE standard whenever the operands and result all have normal values.

**Note:** NaN and Infinity are not fully supported for **REAL(16)**. Arithmetic operations do not necessarily propagate these values.

**Module:** **IEEE\_ARITHMETIC**

**Syntax:** Where *X* is a scalar or array valued argument of type real.

**Result type and attributes:** The result is a scalar of type default logical.

**Rules:** If *X* is absent, the function returns a value of false.

If *X* is present and **REAL(16)**, the function returns a value of false. Otherwise the function returns true.

**Examples:**

```
USE, INTRINSIC :: IEEE_ARITHMETIC
TYPE(IEEE_STATUS_TYPE) STATUS_VALUE
...
CALL IEEE_GET_STATUS(STATUS_VALUE) ! Get status of all exception flags
```

```
CALL IEEE_SET_FLAG(IEEE_ALL,.FALSE.) ! Set all exception flags to quiet
... ! calculation involving exception handling
CALL IEEE_SET_STATUS(STATUS_VALUE) ! Restore the flags
```

### **IEEE\_SUPPORT\_DENORMAL or IEEE\_SUPPORT\_DENORMAL(X)**

**Type:** An inquiry IEEE function. Determines whether the current implementation supports denormalized numbers.

**Module:** IEEE\_ARITHMETIC

**Syntax:** Where *X* is a scalar or array valued argument of type real.

**Result type and attributes:** The result is a scalar of type default logical.

**Rules:** To ensure compliance with the Fortran 2003 standard, the IEEE\_SUPPORT\_DATATYPE(X) must return with a value of true.

The result has a value of true if the implementation supports arithmetic operations and assignments with denormalized numbers for all arguments of type real where *X* is absent, or for real variables of the same kind type parameter as *X*. Otherwise, the result has a value of false.

### **IEEE\_SUPPORT\_DIVIDE or IEEE\_SUPPORT\_DIVIDE(X)**

**Type:** An inquiry IEEE function. Determines whether the current implementation supports division to the accuracy of the IEEE standard.

**Module:** IEEE\_ARITHMETIC

**Syntax:** Where *X* is a scalar or array valued argument of type real.

**Result type and attributes:** The result is a scalar of type default logical.

**Rules:** To ensure compliance with the Fortran 2003 standard, the IEEE\_SUPPORT\_DATATYPE(X) must return with a value of true.

The result has a value of true if the implementation supports division with the accuracy specified by the IEEE standard for all arguments of type real where *X* is absent, or for real variables of the same kind type parameter as *X*. Otherwise, the result has a value of false.

### **IEEE\_SUPPORT\_FLAG(FLAG) or IEEE\_SUPPORT\_FLAG(FLAG, X)**

**Type:** An inquiry IEEE function. Determines whether the current implementation supports an exception.

**Module:** IEEE\_EXCEPTIONS

**Syntax:** Where *FLAG* is a scalar argument of IEEE\_FLAG\_TYPE. *X* is a scalar or array valued argument of type real.

**Result type and attributes:** The result is a scalar of type default logical.

**Rules:** The result has a value of true if the implementation supports detection of the exception specified for all arguments of type real where *X* is absent, or for real variables of the same kind type parameter as *X*. Otherwise, the result has a value of false.

If *X* is absent, the result has a value of false.

If *X* is present and of type **REAL(16)**, the result has a value of false. Otherwise the result has a value of true.

### **IEEE\_SUPPORT\_HALTING(FLAG)**

**Type:** An inquiry IEEE function. Determines whether the current implementation supports the ability to abort or continue execution after an exception occurs. Support by the current implementation includes the ability to change the halting mode using **IEEE\_SET\_HALTING(FLAG)**.

**Module:** **IEEE\_EXCEPTIONS**

**Syntax:** Where *FLAG* is an **INTENT(IN)** argument of **IEEE\_FLAG\_TYPE**.

**Result type and attributes:** The result is a scalar of type default logical.

**Rules:** The result returns with a value of true for all flags.

### **IEEE\_SUPPORT\_INF or IEEE\_SUPPORT\_INF(X)**

**Type:** An inquiry IEEE function. Support indicates that IEEE infinity behavior for unary and binary operations, including those defined by intrinsic functions and by functions in intrinsic modules, complies with the IEEE standard.

**Module:** **IEEE\_ARITHMETIC**

**Syntax:** Where *X* is a scalar or array valued argument of type real.

**Result type and attributes:** The result is a scalar of type default logical.

**Rules:** To ensure compliance with the Fortran 2003 standard, the **IEEE\_SUPPORT\_DATATYPE(X)** must return with a value of true.

The result has a value of true if the implementation supports IEEE positive and negative infinities for all arguments of type real where *X* is absent, or for real variables of the same kind type parameter as *X*. Otherwise, the result has a value of false.

If *X* is of type **REAL(16)**, the result has a value of false. Otherwise the result has a value of true.

### **IEEE\_SUPPORT\_IO or IEEE\_SUPPORT\_IO(X)**

**Type:** An inquiry IEEE function. Determines whether the current implementation supports IEEE base conversion rounding during formatted input/output. Support refers the ability to do IEEE base conversion during formatted input/output as described in the IEEE standard for the modes **IEEE\_UP**, **IEEE\_DOWN**, **IEEE\_ZERO**, and **IEEE\_NEAREST** for all arguments of type real where *X* is absent, or for real variables of the same kind type parameter as *X*.

**Module:** **IEEE\_ARITHMETIC**

**Syntax:** Where *X* is a scalar or array valued argument of type real.

**Result type and attributes:** The result is a scalar of type default logical.

**Rules:** To ensure compliance with the Fortran 2003 standard, the `IEEE_SUPPORT_DATATYPE(X)` must return with a value of true.

If *X* is present and of type `REAL(16)`, the result has a value of false. Otherwise, the result returns a value of true.

### **IEEE\_SUPPORT\_NAN or IEEE\_SUPPORT\_NAN(X)**

**Type:** An inquiry IEEE function. Determines whether the current implementation supports the IEEE Not-a-Number facility. Support indicates that IEEE NaN behavior for unary and binary operations, including those defined by intrinsic functions and by functions in intrinsic modules, conforms to the IEEE standard.

**Module:** `IEEE_ARITHMETIC`

**Syntax:** Where *X* is a scalar or array valued argument of type real.

**Result type and attributes:** The result is a scalar of type default logical.

**Rules:** To ensure compliance with the Fortran 2003 standard, the `IEEE_SUPPORT_DATATYPE(X)` must return with a value of true.

If *X* is absent, the result has a value of false.

If *X* is present and of type `REAL(16)`, the result has a value of false. Otherwise the result returns a value of true.

### **IEEE\_SUPPORT\_ROUNDING (ROUND\_VALUE) or IEEE\_SUPPORT\_ROUNDING (ROUND\_VALUE, X)**

**Type:** An inquiry IEEE function. Determines whether the current implementation supports a particular rounding mode for arguments of type real. Support indicates the ability to change the rounding mode using `IEEE_SET_ROUNDING_MODE`.

**Module:** `IEEE_ARITHMETIC`

**Syntax:** Where *ROUND\_VALUE* is a scalar argument of `IEEE_ROUND_TYPE`. *X* is a scalar or array valued argument of type real.

**Result type and attributes:** The result is a scalar of type default logical.

**Rules:** To ensure compliance with the Fortran 2003 standard, the `IEEE_SUPPORT_DATATYPE(X)` must return with a value of true.

If *X* is absent, the result has a value of true if the implementation supports the rounding mode defined by `ROUND_VALUE` for all arguments of type real. Otherwise, it has a value of false.

If *X* is present, the result returns a value of true if the implementation supports the rounding mode defined by `ROUND_VALUE` for real variables of the same kind type parameter as *X*. Otherwise, the result has a value of false.

If  $X$  is present and of type **REAL(16)**, the result returns a value of false when **ROUND\_VALUE** has a value of **IEEE\_NEAREST**. Otherwise the result returns a value of true.

If **ROUND\_VALUE** has a value of **IEEE\_OTHER** the result has a value of false.

### **IEEE\_SUPPORT\_SQRT or IEEE\_SUPPORT\_SQRT(X)**

**Type:** An inquiry IEEE function. Determines whether the current implementation supports the **SQRT** as defined by the IEEE standard.

**Module:** **IEEE\_ARITHMETIC**

**Syntax:** Where  $X$  is a scalar or array valued argument of type real.

**Result type and attributes:** The result is a scalar of type default logical.

**Rules:** To ensure compliance with the Fortran 2003 standard, the **IEEE\_SUPPORT\_DATATYPE(X)** must return with a value of true.

If  $X$  is absent, the result returns a value of true if **SQRT** adheres to IEEE conventions for all variables of type **REAL**. Otherwise, the result has a value of false.

If  $X$  is present, the result returns a value of true if **SQRT** adheres to IEEE conventions for all variables of type **REAL** with the same kind type parameter as  $X$ . Otherwise, the result has a value of false.

If  $X$  is present and of type **REAL(16)**, the result has a value of false. Otherwise the result returns a value of true.

### **IEEE\_SUPPORT\_STANDARD or IEEE\_SUPPORT\_STANDARD(X)**

**Type:** An inquiry IEEE function. Determines whether all facilities defined in the Fortran 2003 standard are supported.

**Module:** **IEEE\_ARITHMETIC**

**Syntax:** Where  $X$  is a scalar or array valued argument of type real.

**Result type and attributes:** The result is a scalar of type default logical.

**Rules:** If  $X$  is absent, the result returns a value of false since XL Fortran supports **REAL(16)**.

If  $X$  is present, the result returns a value of true if the following functions also return true:

- **IEEE\_SUPPORT\_DATATYPE(X)**
- **IEEE\_SUPPORT\_DENORMAL(X)**
- **IEEE\_SUPPORT\_DIVIDE(X)**
- **IEEE\_SUPPORT\_FLAG(FLAG, X)** for every valid flag.
- **IEEE\_SUPPORT\_HALTING(FLAG)** for every valid flag.
- **IEEE\_SUPPORT\_INF(X)**
- **IEEE\_SUPPORT\_NAN(X)**

- `IEEE_SUPPORT_ROUNDING(ROUND_VALUE, X)` for every valid `ROUND_VALUE`
- `IEEE_SUPPORT_SQRT(X)`

Otherwise, the result returns a value of false.

## **IEEE\_UNORDERED(X, Y)**

**Type:** An elemental IEEE unordered function.

**Module:** `IEEE_ARITHMETIC`

**Syntax:** Where *X* and *Y* are of type real.

**Result type and attributes:** The result is of type default logical.

**Rules:** To ensure compliance with the Fortran 2003 standard, the `IEEE_SUPPORT_DATATYPE(X)` and `IEEE_SUPPORT_DATATYPE(Y)` must return with a value of true.

Unordered function that returns with a value of true if *X* or *Y* is a NaN. Otherwise the function returns with a value of false.

### **Examples:**

```
USE, INTRINSIC :: IEEE_ARITHMETIC
REAL X, Y
X = 0.0
Y = IEEE_VALUE(Y, IEEE_QUIET_NAN)
PRINT *, IEEE_UNORDERED(X,Y) ! Prints true
END
```

## **IEEE\_VALUE(X, CLASS)**

**Type:** An elemental IEEE function. Generates an IEEE value as specified by *CLASS*.

**Note:** Implementation of this function is platform and compiler dependent due to variances in NaN processing on differing platforms. A NaN value saved in a binary file that is read on a different platform than the one that generated the value will have unspecified results.

**Module:** `IEEE_ARITHMETIC`

**Syntax:** Where *X* is of type real. *CLASS* is of type `IEEE_CLASS_TYPE`.

**Result type and attributes:** The result is of the same type and kind as *X*.

**Rules:** To ensure compliance with the Fortran 2003 standard, the `IEEE_SUPPORT_DATATYPE(X)` must return with a value of true.

`IEEE_SUPPORT_NAN(X)` must be true if the value of *CLASS* is `IEEE_SIGNALING_NAN` or `IEEE_QUIET_NAN`.

`IEEE_SUPPORT_INF(X)` must be true if the value of *CLASS* is `IEEE_NEGATIVE_INF` or `IEEE_POSITIVE_INF`.

`IEEE_SUPPORT_DENORMAL(X)` must be true if the value of *CLASS* is `IEEE_NEGATIVE_DENORMAL` or `IEEE_POSITIVE_DENORMAL`.



Multiple calls of `IEEE_VALUE(X, CLASS)` return the same result for a particular value of `X`, if kind type parameter and `CLASS` remain the same.

If a compilation unit calls this program with a `CLASS` value of `IEEE_SIGNALING_NAN`, the compilation unit must be compiled with the `-qfloat=nans` compiler option.

**Examples:**

```
USE, INTRINSIC :: IEEE_ARITHMETIC
REAL :: X
IF (IEEE_SUPPORT_DATATYPE(X)) THEN
  X = IEEE_VALUE(X, IEEE_NEGATIVE_INF)
  PRINT *, X ! Prints -inf
END IF
```

## Rules for floating-point status

An exception flag set to signaling remains signaling until set to quiet by either the `IEEE_SET_FLAG` or `IEEE_SET_STATUS` subroutines.

The compiler ensures that a call from scoping units using the `IEEE_EXCEPTIONS` or `IEEE_ARITHMETIC` intrinsic modules does not change the floating-point status other than by setting exception flags to signaling.

If a flag is set to signaling on entry into a scoping unit that uses the `IEEE_EXCEPTIONS` or `IEEE_ARITHMETIC` modules, the flag is set to quiet and then restored to signaling when leaving that scoping unit.

In a scoping unit that uses the `IEEE_EXCEPTIONS` or `IEEE_ARITHMETIC` modules, the rounding and halting modes do not change on entry. On return, the rounding and halting modes are the same as on entry.

Evaluating a specification expression can cause an exception to signal.

Exception handlers must not use the `IEEE_EXCEPTIONS` or `IEEE_ARITHMETIC` modules.

The following rules apply to format processing and intrinsic procedures:

- The status of a signaling flag, either signaling or quiet, does not change because of an intermediate calculation that does not affect the result.
- If an intrinsic procedure executes normally, the values of the flags `IEEE_OVERFLOW`, `IEEE_DIVIDE_BY_ZERO`, and `IEEE_INVALID` remain the same on entry to the procedure.
- If a real or complex result is too large for the intrinsic to handle, `IEEE_OVERFLOW` may signal.
- If a real or complex result is a NaN because of an invalid operation, `IEEE_INVALID` may signal.

In a sequence of statements that has no invocations of `IEEE_GET_FLAG`, `IEEE_SET_FLAG`, `IEEE_GET_STATUS`, `IEEE_SET_HALTING`, or `IEEE_SET_STATUS`, the following applies. If the execution of an operation would cause an exception to signal but after execution of the sequence no value of a variable depends on the operation, whether the exception is signaling depends on the optimization level. Optimization transformations may eliminate some code, and thus IEEE exception flags signaled by the eliminated code will not signal.

An exception will not signal if this could arise only during execution of an operation beyond those required or permitted by the standard.

For procedures defined by means other than Fortran, it is the responsibility of the user to preserve floating-point status.

XL Fortran does not always detect floating-point exception conditions for extended precision values. If you turn on floating-point exception trapping in programs that use extended precision, XL Fortran may also generate signals in cases where an exception does not really occur. See Detecting and trapping floating-point exceptions in the *XL Fortran Optimization and Programming Guide* for more information.

Fortran 2003 IEEE derived types, constants, and operators are incompatible with the floating-point and inquiry procedures in `xlf_fp_util`, `fpsets`, and `fpgets` procedures. A value obtained from an IEEE procedure cannot be used in non-IEEE procedures. Within a single scoping unit, do not mix calls to the procedures in `xlf_fp_util`, `fpsets`, and `fpgets` with calls to the IEEE procedures. These procedures may change the floating-point status when called from scoping units that use the `IEEE_EXCEPTIONS` or `IEEE_ARITHMETIC` modules.

## Examples

**Example 1:** In the following example, the main program calls procedure *P* which uses the `IEEE_ARITHMETIC` module. The procedure changes the floating-point status before returning. The example displays the changes to the floating-point status before calling procedure *P*, on entry into the procedure, on exit from *P*, and after returning from the procedure.

```
PROGRAM MAIN
  USE, INTRINSIC :: IEEE_ARITHMETIC

  INTERFACE
    SUBROUTINE P()
      USE IEEE_ARITHMETIC
    END SUBROUTINE P
  END INTERFACE

  LOGICAL, DIMENSION(5) :: FLAG_VALUES
  TYPE(IEEE_ROUND_TYPE) :: ROUND_VALUE

  CALL IEEE_SET_FLAG(IEEE_OVERFLOW, .TRUE.)

  CALL IEEE_GET_FLAG(IEEE_ALL, FLAG_VALUES)
  PRINT *, "MAIN: FLAGS ", FLAG_VALUES

  CALL P()

  CALL IEEE_GET_FLAG(IEEE_ALL, FLAG_VALUES)
  PRINT *, "MAIN: FLAGS ", FLAG_VALUES

  CALL IEEE_GET_ROUNDING_MODE(ROUND_VALUE)
  IF (ROUND_VALUE == IEEE_NEAREST) THEN
    PRINT *, "MAIN: ROUNDING MODE: IEEE_NEAREST"
  ENDIF
END PROGRAM MAIN

SUBROUTINE P()
  USE IEEE_ARITHMETIC
  LOGICAL, DIMENSION(5) :: FLAG_VALUES
  TYPE(IEEE_ROUND_TYPE) :: ROUND_VALUE

  CALL IEEE_GET_FLAG(IEEE_ALL, FLAG_VALUES)
```

```

PRINT *, " P: FLAGS ON ENTRY: ",FLAG_VALUES

CALL IEEE_SET_ROUNDING_MODE(IEEE_TO_ZERO)
CALL IEEE_SET_FLAG(IEEE_UNDERFLOW, .TRUE.)

CALL IEEE_GET_ROUNDING_MODE(ROUND_VALUE)
IF (ROUND_VALUE == IEEE_TO_ZERO) THEN
  PRINT *, " P: ROUNDING MODE ON EXIT: IEEE_TO_ZERO"
ENDIF
CALL IEEE_GET_FLAG(IEEE_ALL, FLAG_VALUES)
PRINT *, " P: FLAGS ON EXIT: ",FLAG_VALUES
END SUBROUTINE P

```

When using the `-qstrictieemod` compiler option to ensure compliance with rules for IEEE arithmetic, exception flags set before calling *P* are cleared on entry to *P*. Changes to the floating-point status occurring in *P* are undone when *P* returns, with the exception that flags set in *P* remain set after *P* returns:

```

MAIN: FLAGS T F F F F
      P: FLAGS ON ENTRY: F F F F F
      P: ROUNDING MODE ON EXIT: IEEE_TO_ZERO
      P: FLAGS ON EXIT: F F F T F
MAIN: FLAGS T F F T F
MAIN: ROUNDING MODE: IEEE_NEAREST

```

When the `-qnostrictieemod` compiler option is in effect, exception flags which were set before calling *P* remain set on entry to *P*. Changes to the floating point status occurring in *P* are propagated to the caller.

```

MAIN: FLAGS T F F F F
      P: FLAGS ON ENTRY: T F F F F
      P: ROUNDING MODE ON EXIT: IEEE_TO_ZERO
      P: FLAGS ON EXIT: T F F T F
MAIN: FLAGS T F F T F

```

**Example 2:** In the following example, the main program calls procedure *Q* which uses neither `IEEE_ARITHMETIC` nor `IEEE_EXCEPTIONS`. Procedure *Q* changes the floating-point status before returning. The example displays the changes to the floating-point status before calling *Q*, on entry into the procedure, on exit from *Q*, and after returning from the procedure.

```

PROGRAM MAIN
  USE, INTRINSIC :: IEEE_ARITHMETIC

  LOGICAL, DIMENSION(5) :: FLAG_VALUES
  TYPE(IEEE_ROUND_TYPE) :: ROUND_VALUE

  CALL IEEE_SET_FLAG(IEEE_OVERFLOW, .TRUE.)

  CALL IEEE_GET_FLAG(IEEE_ALL, FLAG_VALUES)
  PRINT *, "MAIN: FLAGS ",FLAG_VALUES

  CALL Q()

  CALL IEEE_GET_FLAG(IEEE_ALL, FLAG_VALUES)
  PRINT *, "MAIN: FLAGS ",FLAG_VALUES

  CALL IEEE_GET_ROUNDING_MODE(ROUND_VALUE)
  IF (ROUND_VALUE == IEEE_NEAREST) THEN
    PRINT *, "MAIN: ROUNDING MODE: IEEE_NEAREST"
  ENDIF
END PROGRAM MAIN

SUBROUTINE Q()
  USE XLF_FP_UTIL
  INTERFACE

```

```

        FUNCTION GET_FLAGS()
            LOGICAL, DIMENSION(5) :: GET_FLAGS
        END FUNCTION
    END INTERFACE

    LOGICAL, DIMENSION(5) :: FLAG_VALUES
    INTEGER(FP_MODE_KIND) :: OLDMODE

    FLAG_VALUES = GET_FLAGS()
    PRINT *, "  Q: FLAGS ON ENTRY: ", FLAG_VALUES

    CALL CLR_FPSCR_FLAGS(FP_OVERFLOW)
    OLDMODE = SET_ROUND_MODE(FP_RND_RZ)
    CALL SET_FPSCR_FLAGS(TRP_OVERFLOW)
    CALL SET_FPSCR_FLAGS(FP_UNDERFLOW)

    IF (GET_ROUND_MODE() == FP_RND_RZ) THEN
        PRINT *, "  Q: ROUNDING MODE ON EXIT: TO_ZERO"
    ENDIF

    FLAG_VALUES = GET_FLAGS()
    PRINT *, "  Q: FLAGS ON EXIT: ", FLAG_VALUES
END SUBROUTINE Q

! PRINT THE STATUS OF ALL EXCEPTION FLAGS
FUNCTION GET_FLAGS()
    USE XLF_FP_UTIL
    LOGICAL, DIMENSION(5) :: GET_FLAGS
    INTEGER(FPSCR_KIND), DIMENSION(5) :: FLAGS
    INTEGER I

    FLAGS = (/ FP_OVERFLOW, FP_DIV_BY_ZERO, FP_INVALID, &
             & FP_UNDERFLOW, FP_INEXACT /)
    DO I=1,5
        GET_FLAGS(I) = (GET_FPSCR_FLAGS(FLAGS(I)) /= 0)
    END DO
END FUNCTION

```

When using the `-qstrictieemod` compiler option to ensure compliance with rules for IEEE arithmetic, exception flags set before `Q` remain set on entry into `Q`. Changes to the floating-point status occurring in `Q` are undone when `Q` returns, with the exception that flags set in `Q` remain set after `Q` returns:

```

MAIN: FLAGS  T F F F F
      Q: FLAGS ON ENTRY:  T F F F F
      Q: ROUNDING MODE ON EXIT: TO_ZERO
      Q: FLAGS ON EXIT:  F F F T F
MAIN: FLAGS  T F F T F
MAIN: ROUNDING MODE: IEEE_NEAREST

```

When the `-qnostrictieemod` option is in effect, exception flags set before calling `Q` remain set on entry into `Q`. Changes to the floating point status occurring in `Q` are propagated to the caller.

```

MAIN: FLAGS  T F F F F
      Q: FLAGS ON ENTRY:  T F F F F
      Q: ROUNDING MODE ON EXIT: TO_ZERO
      Q: FLAGS ON EXIT:  F F F T F
MAIN: FLAGS  F F F T F

```

End of Fortran 2003

---

## Chapter 20. Service and utility procedures

---

### IBM Extension

---

XL Fortran provides utility services that are available to the Fortran programmer. This section describes the rules for the general service and utility procedures, then provides an alphabetical reference to these procedures.

---

### General service and utility procedures

The general service and utility procedures belong to the `xlutility` module. To ensure that the functions are given the correct type and that naming conflicts are avoided, use these procedures in one of the following two ways:

1. XL Fortran supplies the `XLUTILITY` module, which contains the interfaces and data type definitions for these procedures (and the derived-type definitions required for the `dtime_`, `etime_`, `idate_`, and `itime_` procedures). XL Fortran flags arguments that are not compatible with the interface specification in type, kind, and rank. These modules enable type checking of these procedures at compile time rather than at link time. The argument names in the module interface are taken from the examples defined below. The following files are supplied for the `xlutility` and `xlutility_extname` modules:

File names	File type	Locations
<ul style="list-style-type: none"><li>• <code>xlutility.f</code></li><li>• <code>xlutility_extname.f</code></li></ul>	source file	<ul style="list-style-type: none"><li>• <code>/usr/lpp/xlf/samples/modules</code></li></ul>
<ul style="list-style-type: none"><li>• <code>xlutility.mod</code></li><li>• <code>xlutility_extname.mod</code></li></ul>	module symbol file	<ul style="list-style-type: none"><li>• <code>/usr/lpp/xlf/include</code></li><li>• <code>/usr/lpp/xlf/include_d7</code></li></ul>

You can use the precompiled module by adding a `USE` statement to your source file (see “`USE`” on page 468 for details). As well, you can modify the module source file and recompile it to suit your needs. Use the `xlutility_extname` files for procedures compiled with the `-qextname` option. The source file `xlutility_extname.f` has no underscores following procedure names, while `xlutility.f` includes underscores for some procedures names (as listed in this section).

If there are name conflicts (for example if the accessing subprogram has an entity with the same name as a module entity), use the `ONLY` clause or the renaming features of the `USE` statement. For example,  
`USE XLUTILITY, NULL1 => DTIME_, NULL2 => ETIME_`

2. Because these procedures are not intrinsic procedures:
  - You must declare their type to avoid potential problems with implicit typing.
  - When compiling with the `-U` option, you must code the names of these procedures in all lowercase to match the names in the XL Fortran libraries. We will show the names in lowercase here as a reminder.

To avoid conflicts with names in the `libc` library, some procedure names end with an underscore. When coding calls to these procedures, you can:

- Instead of entering the underscore, use the `-brename` linker option to change the name at link time:

```
xlf
-brename:flush,flush_
calls_flush.f
```

This method works best if you need to rename only a small number of procedures.

- Instead of typing the underscore, use the **-qextname** compiler option to add it to the end of each name:

```
xlf -qextname calls_flush.f
```

This method is recommended for programs already written without the underscore following the routine name. The XL Fortran library contains additional entry points, such as **fpgets\_**, so that calls to procedures that do not use trailing underscores still resolve with **-qextname**.

- Depending on the way your program is structured and the particular libraries and object files it uses, you may have difficulty using **-qextname** or **-brename**. In this case, enter the underscores after the appropriate names in the source file:

```
PRINT *, IRTC() ! No underscore in this name
CALL FLUSH_(10) ! But there is one in this name
```

If your program calls the following procedures, there are restrictions on the common block and external procedure names that you can use:

XL F-Provided Function Name	Common Block or External Procedure Name You Cannot Use
mclock	times
rand	irand

**Note:** The **mvbits** subroutine that was in XL Fortran Version 2 is now an intrinsic subroutine, "MVBITS(FROM, FROMPOS, LEN, TO, TOPOS)" on page 619.

---

## List of service and utility procedures

This section lists the service and utility procedures available in the XLFUTILITY module.

Any application that uses the interfaces for the procedures **ctime\_**, **gmtime\_**, **ltime\_**, or **time\_** uses the symbolic constant **TIME\_SIZE** to specify the kind type parameter of certain intrinsic data types. The XLFUTILITY module defines **TIME\_SIZE**.

**TIME\_SIZE** is set to 4 for 32-bit applications. For 64-bit applications **TIME\_SIZE** is set to 8.

**Note:** **CHARACTER(n)** means that you can specify any length for the variable.

---

### alarm\_(time, func)

#### Purpose

The **alarm\_** function sends an alarm signal at the specified time to invoke the specified function.

## Class

Function

## Argument type and attributes

**time** INTEGER(4), INTENT(IN)

**func** A function that returns a result of type INTEGER(4).

## Result type and attributes

INTEGER(4)

## Result value

The returned value is the remaining time from the last alarm.

---

## bic\_(X1, X2)

### Purpose

The **bic\_** subroutine sets bit *X1* of *X2* to 0. For greater portability, it is recommended that you use the IBCLR standard intrinsic procedure instead of this procedure.

### Class

Subroutine

### Argument type and attributes

**X1** INTEGER(4), INTENT(IN)

The range of **X1** must be within 0 to 31, inclusive.

**X2** INTEGER(4), INTENT(INOUT)

---

## bis\_(X1, X2)

### Purpose

The **bis\_** subroutine sets bit *X1* of *X2* to 1. For greater portability, it is recommended that you use the IBSET standard intrinsic procedure instead of this procedure.

### Class

Subroutine

### Argument type and attributes

**X1** INTEGER(4), INTENT(IN)

The range of **X1** must be within 0 to 31, inclusive.

**X2** INTEGER(4), INTENT(INOUT)

---

## bit\_(X1, X2)

### Purpose

The **bit\_** function returns the value **.TRUE.** if bit *X1* of *X2* equals 1. Otherwise, **bit\_** returns the value **.FALSE.** For greater portability, it is recommended that you use the BTEST standard intrinsic procedure instead of this procedure.

### Class

Function

### Argument type and attributes

**X1**     INTEGER(4), INTENT(IN)

The range of **X1** must be within 0 to 31, inclusive.

**X2**     INTEGER(4), INTENT(IN)

### Result type and attributes

LOGICAL(4)

### Result value

This function returns **.TRUE.** if bit **X1** of **X2** equals 1. Otherwise this function returns **.FALSE.**

---

## clock\_()

### Purpose

The **clock\_** function returns the time in hh:mm:ss format. This function is different from the operating system clock function.

### Class

Function

### Result type and attributes

CHARACTER(8)

### Result value

The time in hh:mm:ss format

---

## ctime\_(STR, TIME)

### Purpose

The **ctime\_** subroutine converts the system time **TIME** to a 26-character ASCII string and outputs the result into the first argument.

### Class

Subroutine



## Argument type and attributes

**STR** CHARACTER(26), INTENT(OUT)

**TIME** INTEGER(KIND=TIME\_SIZE), INTENT(IN)

---

## date()

### Purpose

The date function returns the current date in mm/dd/yy format.

### Class

Function

### Result type and attributes

CHARACTER(8)

### Result value

The current date in mm/dd/yy format

---

## dttime\_(dttime\_struct)

### Purpose

The **dttime\_** function sets the time accounting information for the user time and system time in DTIME\_STRUCT. The resolution for all timing is 1/100 of a second. The output appears in units of seconds.

### Class

Function

### Argument type and attributes

```
dttime_struct
  TYPE TB_TYPE
  SEQUENCE
    REAL(4) USRTIME
    REAL(4) SYSTIME
  END TYPE
  TYPE (TB_TYPE) DTIME_STRUCT
```

### Result type and attributes

REAL(4)

### Result value

The returned value is the sum of the user time and the system time since the last call to **dttime\_**.

---

## **etime\_(etime\_struct)**

### **Purpose**

The **etime\_** function sets the user-elapsed time and system-elapsed time in **ETIME\_STRUCT** since the start of the execution of a process. The resolution for all timing is 1/100 of a second. The output appears in units of seconds.

### **Class**

Function

### **Argument type and attributes**

```
etime_struct
  TYPE TB_TYPE
  SEQUENCE
    REAL(4) USRTIME
    REAL(4) SYSTIME
  END TYPE
  TYPE (TB_TYPE) ETIME_STRUCT
```

### **Result type and attributes**

REAL(4)

### **Result value**

The returned value is the sum of the user-elapsed time and the system-elapsed time.

---

## **exit\_(exit\_status)**

### **Purpose**

The **exit\_** subroutine stops execution of the process with the exit status of **EXIT\_STATUS**.

### **Class**

Subroutine

### **Argument type and attributes**

```
exit_status
  INTEGER(4)
```

---

## **fdate\_(str)**

### **Purpose**

The **fdate\_** subroutine returns the date and time in a 26-character ASCII string. The ASCII string is returned in argument **STR**.

### **Class**

Subroutine

## Argument type and attributes

str CHARACTER(26)

---

### fiosetup\_(unit, command, argument)

#### Purpose

The `fiosetup_` function sets up the requested I/O behavior for the logical unit specified by `UNIT`. The request is specified by argument `COMMAND`. The argument `ARGUMENT` is an argument to the `COMMAND`. The Fortran include file `'fiosetup_.h'` is supplied with the compiler to define symbolic constants for the `fiosetup_` arguments and error return codes.

#### Class

Function

## Argument type and attributes

**unit** A logical unit that is currently connected to a file  
INTEGER(4).

**command**  
INTEGER(4).

`IO_CMD_FLUSH_AFTER_WRITE` (1). Specifies whether the buffers of the specified `UNIT` be flushed after every `WRITE` statement.

`IO_CMD_FLUSH_BEFORE_READ` (2). Specifies whether the buffers of the specified `UNIT` be flushed before every `READ` statement. This can be used to refresh the data currently in the buffers.

**argument**  
INTEGER(4).

`IO_ARG_FLUSH_YES` (1). Causes the buffers of the specified `UNIT` to be flushed after every `WRITE` statement. This argument should be specified with the commands `IO_CMD_FLUSH_AFTER_WRITE` and `IO_CMD_FLUSH_BEFORE_READ`.

`IO_ARG_FLUSH_NO` (0) Instructs the I/O library to flush buffers at its own discretion. Note the units connected to certain device types must be flushed after each `WRITE` operation regardless of the `IO_CMD_FLUSH_AFTER_WRITE` setting. Such devices include terminals and pipes. This argument should be specified with the commands `IO_CMD_FLUSH_AFTER_WRITE` and `IO_CMD_FLUSH_BEFORE_READ`. This is the default setting for both commands.

## Result type and attributes

INTEGER(4).

## Result value

On successful completion, this function returns 0. Otherwise, this function returns one of the following errors:

**IO\_ERR\_NO\_RTE (1000)**

The run-time environment is not running.

**IO\_ERR\_BAD\_UNIT (1001)**

The specified UNIT is not connected.

**IO\_ERR\_BAD\_CMD (1002)**

Invalid command.

**IO\_ERR\_BAD\_ARG (1003)**

Invalid argument.

---

## flush\_(lunit)

### Purpose

The **flush\_** subroutine flushes the contents of the input/output buffer for the logical unit LUNIT. The value of LUNIT must be within the range  $0 \leq \text{LUNIT} \leq 2^{31}-1$ .

For greater portability, use the **FLUSH** statement instead of this procedure.

### Class

Subroutine

### Argument type and attributes

**lunit** INTEGER(4), INTENT(IN)

---

## ftell\_(lunit)

### Purpose

The **ftell\_** function returns the offset of the current byte relative to the beginning of the file associated with the specified logical unit UNIT.

The offset returned by the **ftell\_** function is the result of previously completed I/O operations. No references to **ftell\_** on a unit with outstanding asynchronous data transfer operations are allowed until the matching **WAIT** statements for all outstanding asynchronous data transfer operations on the same unit are executed.

### Class

Function

### Argument type and attributes

**lunit** INTEGER(4), INTENT(IN)

### Result type and attributes

INTEGER(4)

### Result value

The offset returned by the **ftell\_** function is the absolute offset of the current byte relative to the beginning of the file. This means that all bytes from the beginning of the file to the current byte are counted, including the data of the records and record terminators if they are present.

If the unit is not connected, the **ftell\_** function returns -1.

---

## ftell64\_(lunit)

### Purpose

The **ftell64\_** function returns the offset of the current byte relative to the beginning of the file associated with the specified logical unit **UNIT**. The **ftell64** function allows you to query files larger than 2 gigabytes in large file enabled file systems.

The offset returned by the **ftell\_** function is the result of previously completed I/O operations. No references to **ftell64\_** on a unit with outstanding asynchronous data transfer operations are allowed until the matching **WAIT** statements for all outstanding asynchronous data transfer operations on the same unit are executed.

### Class

Function

### Argument type and attributes

**lunit** INTEGER(4), INTENT(IN)

### Result type and attributes

The offset returned by the **ftell64\_** function is the absolute offset of the current byte relative to the beginning of the file. This means that all bytes from the beginning of the file to the current byte are counted, including the data of the records and record terminators if they are present.

**ftell64\_** returns INTEGER(8).

### Result value

If the unit is not connected, the **ftell64\_** function returns -1.

---

## getarg(i1,c1)

### Purpose

The **getarg** subroutine returns a command line argument of the current process. *I1* is an integer argument that specifies which command line argument to return. *C1* is an argument of character type and will contain, upon return from **getarg**, the command line argument. If *I1* is equal to 0, the program name is returned.

For greater portability, use the **GET\_COMMAND\_ARGUMENT** intrinsic instead of this procedure.

### Class

Subroutine

### Argument type and attributes

**i1** INTEGER(4), INTENT(IN)

**c1** CHARACTER(X), INTENT(OUT)

*X* is the maximum number of characters *c1* can hold.

---

## getcwd\_(name)

### Purpose

The `getcwd_` function retrieves the pathname `NAME` of the current working directory where the maximum length is 1024 characters.

### Class

Function

### Argument type and attributes

`name` A character string of maximum length 1024

### Result type and attributes

INTEGER(4)

### Result value

On successful completion, this function returns 0. Otherwise, it returns a system error code (*errno*).

---

## getfd(lunit)

### Purpose

Given a Fortran logical unit, the `getfd` function returns the underlying file descriptor for that unit, or -1 if the unit is not connected.

**Note:** Because XL Fortran does its own I/O buffering, using this function may require special care, as described in Mixed-language input and output in the *XL Fortran Optimization and Programming Guide*.

### Class

Function

### Argument type and attributes

`lunit` INTEGER(4), INTENT(IN)

### Result type and attributes

INTEGER(4)

### Result value

This function returns the underlying file descriptor of the given logical unit, or -1 if the unit is not connected.

---

## getgid\_()

### Purpose

The `getgid_` function returns the group id of a process, where `GROUP_ID` is the requested real group id of the calling process.

## Class

Function

## Result type and attributes

INTEGER(4)

## Result value

The group id of a process

---

## getlog\_(name)

### Purpose

The **getlog\_** subroutine stores the user's login name in NAME. NAME has a maximum length of 8 characters. If the user's login name is not found, NAME is filled with blanks.

## Class

Subroutine

## Argument type and attributes

**name** CHARACTER(8), INTENT(OUT)

---

## getpid\_()

### Purpose

The **getpid\_** function returns the process id of the current process.

## Class

Function

## Result type and attributes

INTEGER(4)

## Result value

The process id of the current process

---

## getuid\_()

### Purpose

The **getuid\_** function returns the real user id of the current process.

## Class

Function

## Result type and attributes

INTEGER(4)

## Result value

The real user id of the current process

---

## global\_timef()

### Purpose

The `global_timef` function returns the elapsed time since the first call to `global_timef` was first executed among all running threads. For thread-specific timing results, see the `timef_delta` function.

### Class

Function

### Result type and attributes

REAL(8)

### Result value

This function returns in milliseconds, the global timing results from all running threads. The first call to `global_timef` returns 0.0. The accuracy of an XL Fortran timing function is operating system dependent.

---

## gmtime\_(stime, tarray)

### Purpose

The `gmtime_` subroutine converts the system time `STIME` into the array `TARRAY`. The data is stored in `TARRAY` in the following order:

- seconds (0 to 59)
- minutes (0 to 59)
- hours (0 to 23)
- day of the month (1 to 31)
- month of the year (0 to 11)
- year (year = current year - 1900)
- day of week (Sunday = 0)
- day of year (0 to 365)
- daylight saving time (0 or 1)

### Class

Subroutine

### Argument type and attributes

`stime` INTEGER(KIND=TIME\_SIZE), INTENT(IN)

`tarray` INTEGER(4), INTENT(OUT) :: tarray(9)

---

## hostnm\_(name)

### Purpose

The `hostnm_` function retrieves the machine's host name `NAME`. `NAME` has a maximum length of 63 characters.



For greater portability, use the `GET_ENVIRONMENT_VARIABLE` intrinsic instead of this procedure.

## Class

Function

## Argument type and attributes

**name** CHARACTER(*X*), INTENT(OUT)

*X* can be in the range of 1 to 63.

## Result type and attributes

INTEGER(4).

## Result value

The returned value is 0 if the host name is found, and an error number otherwise.

---

## **iargc()**

### Purpose

The **iargc** function returns an integer that represents the number of arguments following the program name that have been entered on the command line at run time.

For greater portability, use the `COMMAND_ARGUMENT_COUNT` intrinsic instead of this procedure.

### Class

Function

### Result type and attributes

INTEGER(4)

### Result value

The number of arguments

---

## **idate\_(idate\_struct)**

### Purpose

The **idate\_** subroutine returns the current date in a numerical format containing the day, month and year.

### Class

Subroutine

## Argument type and attributes

```
idate_struct
  TYPE IDATE_TYPE
  SEQUENCE
  INTEGER(4) IDAY
  INTEGER(4) IMONTH
  INTEGER(4) IYEAR
END TYPE
TYPE (IDATE_TYPE) IDATE_STRUCT
```

---

## ierrno\_()

### Purpose

The `ierrno_` function returns the error number of the last detected system error.

### Class

Function

### Result type and attributes

INTEGER(4)

### Result value

The error number of the last detected system error

---

## irand()

### Purpose

The `irand` function generates a positive integer number greater than 0 and less than or equal to 32768. The intrinsic subroutine "SRAND(SEED)" on page 657 is used to provide the seed value for the random number generator.

### Class

Function

### Result type and attributes

INTEGER(4)

### Result value

A pseudo-random positive integer greater than 0 and less than or equal to 32768

---

## irtc()

### Purpose

The `irtc` function returns the number of nanoseconds since the initial value of the machine's real-time clock.

### Class

Function

## Result type and attributes

INTEGER(8)

## Result value

The number of nanoseconds since the initial value of the machine's real-time clock.

---

## itime\_(itime\_struct)

### Purpose

The `itime_` subroutine returns the current time in a numerical form containing seconds, minutes, and hours in `ITIME_STRUCT`.

### Class

Subroutine

## Argument type and attributes

```
itime_struct
  TYPE IAR
  SEQUENCE
    INTEGER(4) IHR
    INTEGER(4) IMIN
    INTEGER(4) ISEC
  END TYPE
  TYPE (IAR) ITIME_STRUCT
```

---

## jdate()

### Purpose

The `jdate` function returns the current Julian date in `yyddd` format.

### Class

Function

## Result type and attributes

CHARACTER(8)

## Result value

The current Julian date in `yyddd` format

---

## lenchr\_(str)

### Purpose

The `lenchr_` function returns the length of the given character string.

### Class

Function

## Argument type and attributes

**str** CHARACTER(\*), INTENT(IN)

## Result type and attributes

INTEGER(4)

## Result value

The length of the character string

---

## Inblnk\_(str)

### Purpose

The **Inblnk\_** function returns the index of the last non-blank character in the string STR. If the string contains no non-blank characters, 0 is returned.

### Class

Function

## Argument type and attributes

**str** CHARACTER(\*), INTENT(IN)

## Result type and attributes

INTEGER(4)

## Result value

The index of the last non-blank character in the string, or 0 if there are no non-blank characters

---

## Itime\_(stime, tarray)

### Purpose

The **Itime\_** subroutine dissects the system time STIME, which is in seconds, into the array TARRAY containing the GMT where the dissected time is corrected for the local time zone. The data is stored in TARRAY in the following order:

seconds (0 to 59)  
minutes (0 to 59)  
hours (0 to 23)  
day of the month (1 to 31)  
month of the year (0 to 11)  
year (year = current year - 1900)  
day of week (Sunday = 0)  
day of year (0 to 365)  
daylight saving time (0 or 1)

### Class

Subroutine

## Argument type and attributes

**stime** INTEGER(KIND=TIME\_SIZE), INTENT(IN)

tarray INTEGER(4), INTENT(OUT):: tarry(9)

---

## mclock()

### Purpose

The **mclock** function returns time accounting information about the current process and its child processes. The accuracy of an XL Fortran timing function is operating system dependent.

### Class

Function

### Result type and attributes

INTEGER(4)

### Result value

The returned value is the sum of the current process's user time and the user and system time of all child processes. The unit of measure is one one-hundredth (1/100) of a second.

---

## qsort\_(array, len, isize, compar)

### Purpose

The **qsort\_** subroutine performs a parallel quicksort on a one-dimensional array **ARRAY** whose length **LEN** is the number of elements in the array with each element having a size of **ISIZE**, and a user-defined sorting order function **COMPAR** to sort the elements of the array. Requirements for the **COMPAR** function are described under the **qsort** subroutine that is described in the AIX Technical Reference: Base Operating System and Extensions Volume 2.

### Class

Subroutine

### Argument type and attributes

**array** The array to be sorted. It can be of any type.

**len** The number of elements in the array. The argument is of type INTEGER(4).

**isize** The size of a single element of the array. The argument is of type INTEGER(4).

**compar**

A user-defined comparison function used to sort the array.

### Examples

```
INTEGER(4) FUNCTION COMPAR_UP(C1, C2)
INTEGER(4) C1, C2
IF (C1.LT.C2) COMPAR_UP = -1
IF (C1.EQ.C2) COMPAR_UP = 0
IF (C1.GT.C2) COMPAR_UP = 1
RETURN
END
```

```

SUBROUTINE FOO()
  INTEGER(4) COMPAR_UP
  EXTERNAL COMPAR_UP
  INTEGER(4) ARRAY(8), LEN, ISIZE
  DATA ARRAY/0, 3, 1, 2, 9, 5, 7, 4/
  LEN = 6
  ISIZE = 4
  CALL qsort_(ARRAY(3:8), LEN, ISIZE, COMPAR_UP)! sorting ARRAY(3:8)
  PRINT *, ARRAY                               ! result value is [0, 3, 1, 2, 4, 5, 7, 9]
  RETURN
END

```

---

## qsort\_down(array, len, isize)

### Purpose

The **qsort\_down** subroutine performs a parallel quicksort on a one-dimensional array **ARRAY** whose length **LEN** is the number of elements in the array with each element having a size of **ISIZE**. The result is stored in array **ARRAY** in descending order. As opposed to **qsort\_**, the **qsort\_down** subroutine does not require the **COMPAR** function.

### Class

Subroutine

### Argument type and attributes

**array** The array to be sorted. It can be of any type.

**len** The number of elements in the array. The argument is of type **INTEGER(4)**.

**isize** The size of a single element of the array. The argument is of type **INTEGER(4)**.

### Result type and attributes

### Result value

### Examples

```

SUBROUTINE FOO()
  INTEGER(4) ARRAY(8), LEN, ISIZE
  DATA ARRAY/0, 3, 1, 2, 9, 5, 7, 4/
  LEN = 8
  ISIZE = 4
  CALL qsort_down(ARRAY, LEN, ISIZE)
  PRINT *, ARRAY
  ! Result value is [9, 7, 5, 4, 3, 2, 1, 0]
  RETURN
END

```

---

## qsort\_up(array, len, isize)

### Purpose

The **qsort\_up** subroutine performs a parallel quicksort on a one-dimensional, contiguous array **ARRAY** whose length **LEN** is the number of elements in the array

with each element having a size of `ISIZE`. The result is stored in array `ARRAY` in ascending order. As opposed to `qsort_`, the `qsort_up` subroutine does not require the `COMPAR` function.

## Class

Subroutine

## Argument type and attributes

**array** The array to be sorted. It can be of any type.

**len** The number of elements in the array. The argument is of type `INTEGER(4)`.

**isize** The size of a single element of the array. The argument is of type `INTEGER(4)`.

## Examples

```
SUBROUTINE FOO()  
  INTEGER(4) ARRAY(8), LEN, ISIZE  
  DATA ARRAY/0, 3, 1, 2, 9, 5, 7, 4/  
  LEN = 8  
  ISIZE = 4  
  CALL qsort_up(ARRAY, LEN, ISIZE)  
  PRINT *, ARRAY  
  ! Result value is [0, 1, 2, 3, 4, 5, 7, 9]  
  RETURN  
END
```

---

## rtc()

### Purpose

The `rtc` function returns the number of seconds since the initial value of the machine's real-time clock.

### Class

Function

### Result type and attributes

`REAL(8)`

### Result value

The number of seconds since the initial value of the machine's real-time clock

---

## setrteopts(c1)

### Purpose

The `setrteopts` subroutine changes the setting of one or more of the run-time options during the execution of a program. See *Setting run-time options* in the *XL Fortran Compiler Reference* for details about the run-time options.

### Class

Subroutine

## Argument type and attributes

**c1** CHARACTER(X), INTENT(IN)  
X is the length of the run-time option to be set.

---

### sleep\_(sec)

#### Purpose

The **sleep\_** subroutine suspends the execution of the current process for SEC seconds.

#### Class

Subroutine

## Argument type and attributes

**sec** INTEGER(4), INTENT(IN)

---

### time\_()

#### Purpose

The **time\_** function returns the current time (GMT), in seconds.

#### Class

Function

## Result type and attributes

INTEGER(KIND=TIME\_SIZE).

#### Result value

The current time (GMT), in seconds

---

### timef()

#### Purpose

The **timef** function returns the elapsed time in milliseconds since the first call to **timef**. The accuracy of an XL Fortran timing function is operating system dependent.

#### Class

Function

## Result type and attributes

REAL(8)

#### Result value

The elapsed time in milliseconds since the first call to **timef**. The first call to **timef** returns 0.0d0.



---

## timef\_delta(t)

### Purpose

The **timef\_delta** function returns the elapsed time in milliseconds since the last instance **timef\_delta** was called with its argument set to 0.0 within the same thread. In order to get the correct elapsed time, you must determine which region of a thread you want timed. This region must start with a call to **timef\_delta(T0)**, where T0 is initialized (T0=0.0). The next call to **timef\_delta** must use the first call's return value as the input argument if the elapsed time is expected. The accuracy of an XL Fortran timing function is operating system dependent.

### Class

Function

### Argument type and attributes

t        REAL(8)

### Result type and attributes

REAL(8)

### Result value

Time elapsed in milliseconds

---

## umask\_(cmask)

### Purpose

The **umask\_** function sets the file mode creation mask to CMASK.

### Class

Function

### Argument type and attributes

cmask    INTEGER(4), INTENT(IN)

### Result type and attributes

INTEGER(4)

### Result value

The returned value is the previous value of the file mode creation mask.

---

## usleep\_(msec)

### Purpose

The **usleep\_** function suspends the execution of the current process for an interval of MSEC microseconds. The accuracy of an XL Fortran timing function is operating system dependent.

## Class

Function

## Argument type and attributes

`msec` INTEGER(4), INTENT(IN)

## Result type and attributes

INTEGER(4)

## Result value

The returned value is 0 if the function is successful, or an error number otherwise.

---

## `xl__trbk()`

### Purpose

The `xl__trbk` subroutine provides a traceback starting from the invocation point. `xl__trbk` can be called from your code, although not from signal handlers. The subroutine requires no parameters.

### Class

Subroutine

\_\_\_\_\_ End of IBM Extension \_\_\_\_\_

---

## Chapter 21. Extensions for source compatibility

---

### Record structures

---

#### IBM Extension

---

The syntax used for record structures parallels that used for Fortran derived types in most cases. Also, in most cases, the semantics of the two features are parallel. For these reasons, record structures are supported in XL Fortran in a way that makes the two features almost completely interchangeable. Hence,

- An entity of a derived type declared using either syntax can be declared using either a **TYPE** statement or a **RECORD** statement.
- A component of an object of derived type can be selected using either the percent sign or period.
- A derived type declared using the **record structure** declaration has a structure constructor.
- A component of any derived type can be initialized using either the standard "equals" form of initialization or the extended "double slashes" form of initialization.

There are differences, however, as outlined here:

- A standard derived type declaration cannot have a **%FILL** component.
- A **record structure** declaration must not have a **SEQUENCE** or **PRIVATE** statement.
- The **-qalign=struct** option applies only to derived types declared using a **record structure** declaration.
- A derived type declared using a **record structure** declaration may have the same name as an intrinsic type.
- There are differences in the rules for determination of derived types declared using a **record structure** declaration and those declared using a standard derived type declaration.
- A component of a **record structure** cannot have the **PUBLIC** or **PRIVATE** attribute.
- A derived type declared using the **record structure** declaration cannot have the **BIND** attribute or procedures.
- A standard derived type declaration can have zero components, a record structure declaration must have at least one component.

The size of a sequence derived type declared using a standard derived type declaration is equal to the sum of the number of bytes required to hold all of its components.

The size of a sequence derived type declared using a **record structure** declaration is equal to the sum of the number of bytes required to hold all of its components and its padding.

Previously, a numeric sequence structure or character sequence structure that appeared in a common block was treated as if its components were enumerated

directly in the common block. Now, that only applies to structures of a type declared using a standard derived type declaration.

## Declaring record structures

Declaring a record structure declares a user-defined type in the same way that a standard Fortran derived type definition declares a user-defined type. A type declared using a **record structure** declaration is a derived type. For the most part, rules that apply to derived types declared using the standard Fortran syntax apply to derived types declared using the record structure syntax. In those cases where there is a difference, the difference will be called out by referring to the two as derived types declared using a **record structure** declaration and derived types declared using a standard derived type declaration.

**Record structure** declarations follow this syntax:

*record\_structure\_dcl*:

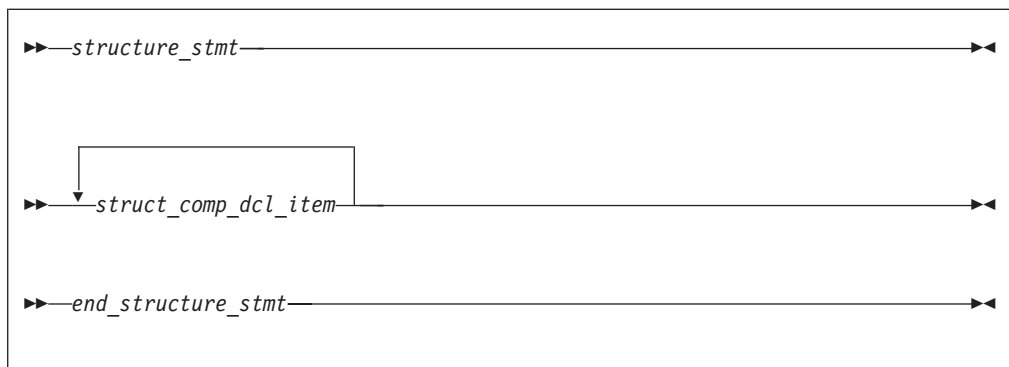

*struct\_comp\_dcl\_item*:



where *component\_def\_stmt* is a type declaration statement used to define the components of the derived type.

*structure\_stmt*:



*component\_dcl*:

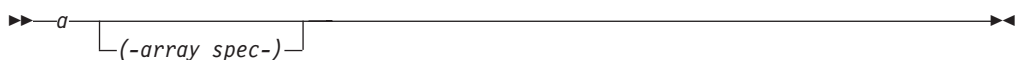

where *a* is an object name.

A structure statement declares the *structure\_name* to be a derived type in the scoping unit of the nearest enclosing program unit, interface body or subprogram. The derived type is a local entity of class 1 in that scoping unit.

A structure statement may not specify a *component\_dcl\_list* unless it is nested in another **record structure** declaration. Likewise, the *structure\_name* of a structure statement cannot be omitted unless it is part of a *record\_structure\_dcl* that is nested in another record structure declaration. A *record\_structure\_dcl* must have at least one component.

A derived type declared using a **record structure** declaration is a sequence derived type, and is subject to all rules that apply to sequence derived types. A component of a type declared using a **record structure** declaration cannot be of a nonsequence derived type, as is true of sequence derived types declared using standard derived type declarations. A **record structure** declaration cannot contain a **PRIVATE** or **SEQUENCE** statement.

A **record structure** declaration defines a scoping unit. All statements in the *record\_structure\_dcl* are part of the scoping unit of the record structure declaration, with the exception of any other *record\_structure\_dcl* contained in the *record\_structure\_dcl*. These rules are also true of standard derived type declarations, repeated here for clarity.

A *parameter\_stmt* in a *record\_structure\_dcl* declares named constants in the scoping unit of the nearest enclosing program unit, interface body or subprogram. A named constant declared in such a *parameter\_stmt* may have the same name as a component declared in the *record\_structure\_dcl* in which it is contained.

Any components declared on a *structure\_stmt* are components of the enclosing derived type, and are local entities of the enclosing structure's scoping unit. The type of such a component is the derived type on whose *structure\_stmt* it is declared.

Unlike derived types declared using a standard derived type declaration, a derived type name declared using a **record structure** declaration may be the same as the name of an intrinsic type.

In place of the name of a component, **%FILL** can be used in a *component\_def\_stmt* in a **record structure** declaration. A **%FILL** component is used as a place-holder to achieve desired alignment of data in a **record structure** declaration. Initialization cannot be specified for a **%FILL** component. Each instance of **%FILL** in a **record structure** declaration is treated as a unique component name, different from the names of all other components you specified for the type, and different from all other **%FILL** components. **%FILL** is a keyword and is not affected by the **-qmixed** compiler option.

Each instance of a nested structure that has no name is treated as if it had a unique name, different from the names of all other accessible entities.

As an extension to the rules described on derived types thus far, the direct components of a derived type declared using a **record structure** declaration are:

- the components of that type that are not **%FILL** components; and
- the direct components of a derived type component that does not have the **ALLOCATABLE** or **POINTER** attributes and is not a **%FILL** component.

The non-filler ultimate components of a derived type are the ultimate components of the derived type that are also direct components.

An object of a derived type with default initialization can be a member of a common block. You must ensure that a common block is not initialized in more than one scoping unit.

## Examples of declaring record structures

### Example 1: Nested record structure declarations - named and unnamed

```
STRUCTURE /S1/  
  STRUCTURE /S2/ A ! A is a component of S1 of type S2  
    INTEGER I  
  END STRUCTURE  
  STRUCTURE B ! B is a component of S1 of unnamed type  
    INTEGER J  
  END STRUCTURE  
END STRUCTURE  
RECORD /S1/ R1  
RECORD /S2/ R2 ! Type S2 is accessible here.  
R2.I = 17  
R1.A = R2  
R1.B.J = 13  
END
```

### Example 2: Parameter statement nested in a structure declaration

```
INTEGER I  
STRUCTURE /S/  
  INTEGER J  
  PARAMETER(I=17, J=13) ! Declares I and J in scope of program unit to  
                          ! be named constants  
END STRUCTURE  
INTEGER J ! Confirms implicit typing of named constant J  
RECORD /S/ R  
R.J = I + J  
PRINT *, R.J ! Prints 30  
END
```

### Example 3: %FILL fields

```
STRUCTURE /S/  
  INTEGER I, %FILL, %FILL(2,2), J  
  STRUCTURE /S2/ R1, %FILL, R2  
    INTEGER I  
  END STRUCTURE  
END STRUCTURE  
RECORD /S/ R  
PRINT *, LOC(R%J)-LOC(R%I) ! Prints 24 with -qintsize=4  
PRINT *, LOC(R%R2)-LOC(R%R1) ! Prints 8 with -qintsize=4  
END
```

## Storage mapping

A derived type declared using a **record structure** declaration is a sequence derived type. In memory, objects of such a type will have the components stored in the order specified. The same is true of objects of a sequence derived type declared using a standard derived type declaration.

The **-qalign** option specifies the alignment of data objects in storage, which avoids performance problems with misaligned data. Both the **[no]4k** and **struct** suboptions can be specified and are not mutually exclusive. The default setting is **-qalign=no4k:struct=natural**. **[no]4K** is useful primarily in combination with logical volume I/O and disk striping.

End of IBM Extension

## Union and map

### IBM Extension

A union declares a group of fields in the enclosing **record structure** that can share the data area in a program.

Unions and maps follow this syntax:

*union\_dcl:*

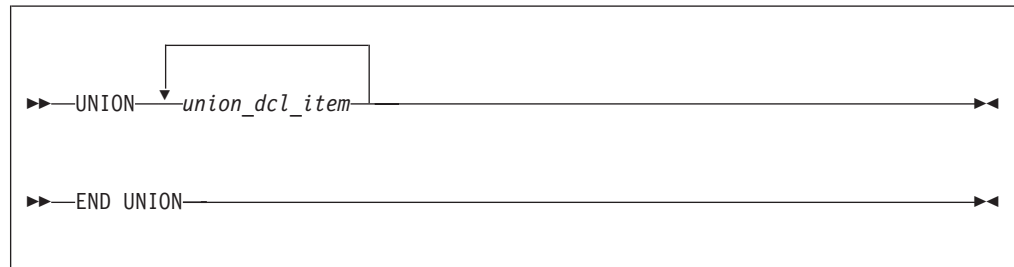

*union\_dcl\_item:*

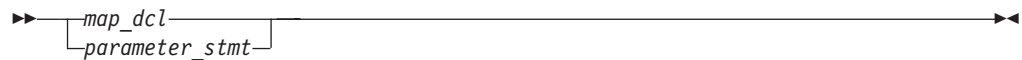

*map\_dcl:*

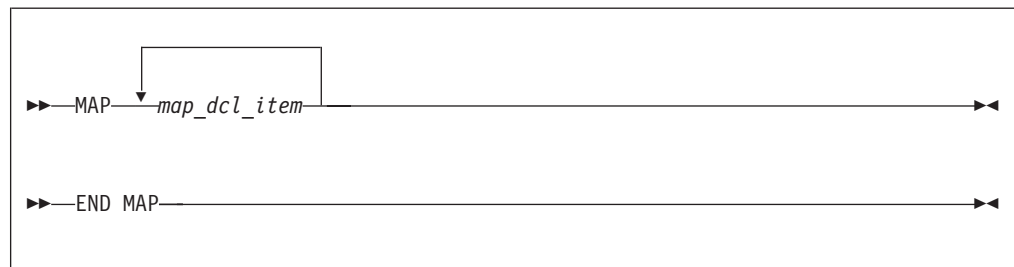

*map\_dcl\_item:*

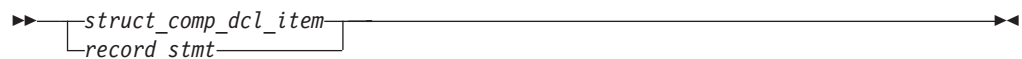

*struct\_comp\_dcl\_item:*



A **union** declaration must be defined in a **record structure**, may be in a **map** declaration, and a **map** declaration must be in a **union** declaration. All declarations in a *map\_dcl\_item* within a union declaration must be of the same nesting level,

regardless of which *map\_dcl* they reside in. Therefore, no component name inside a *map\_dcl* may appear in any other *map\_dcl* on the same level.

A component declared within a **map** declaration must not have a **POINTER**, **F2003** **PRIVATE**, **PUBLIC**, or **ALLOCATABLE** **F2003** attribute.

A record structure with union map must not appear in I/O statements.

The components declared in a **map** declaration share the same storage as the components declared in the other map declarations within a **union** construct. When you assign a value to one component in one **map** declaration, the components in other map declarations that share storage with this component may be affected.

The size of a map is the sum of the sizes of the components declared within it.

The size of the data area established for a **union** declaration is the size of the largest map defined for that union

A *parameter\_stmt* in a **map** declaration or **union** construct declares entities in the scoping unit of the nearest enclosing program unit, interface body, or subprogram.

A **%FILL** field in a **map** declaration is used as a place-holder to achieve desired alignment of data in a record structure. Other non-filler components or part of the components in other map declarations that share the data area with a **%FILL** field are undefined.

If default initialization is specified in *component\_def\_stmts* in at least one **map** declaration in a **union** declaration, the last occurrence of the initialization becomes the final initialization of the components.

If default initialization is specified in one of the union map declarations in a record structure, a variable of that type that will have its storage class assigned by default will be given

- the static storage class if either the **-qsave=defaultinit** or **-qsave=all** option is specified; or
- the automatic storage class, if the **-qnosave** option is specified.

At any time, only one map is associated with the shared storage. If a component from another map is referenced, the associated map becomes unassociated and its components become undefined. The map referenced will then be associated with the storage.

If a component of *map\_dcl* is entirely or partially mapped with the **%FILL** component of the other *map\_dcl* in a union, the value of the overlap portion is undefined unless that component is initialized by default initialization or an assignment statement.

## Examples of union and map

**Example 1: The size of the union is equal to the size of the largest map in that union**

```
structure /S/  
  union  
    map  
      integer*4 i, j, k
```



```

        real*8  r, s, t
    end map
end map
map
    integer*4  p, q
    real*4    u, v
end map
end union      ! Size of the union is 36 bytes.
end structure
record /S/ r

```

**Example 2: The results of union map are different with different -qsave option and suboptions**

```

PROGRAM P
CALL SUB
CALL SUB
END PROGRAM P

SUBROUTINE SUB
LOGICAL, SAVE :: FIRST_TIME = .TRUE.
STRUCTURE /S/
UNION
MAP
    INTEGER I/17/
END MAP
MAP
    INTEGER J
END MAP
END UNION
END STRUCTURE
RECORD /S/ LOCAL_STRUCT
INTEGER LOCAL_VAR

IF (FIRST_TIME) THEN
LOCAL_STRUCT.J = 13
LOCAL_VAR = 19
FIRST_TIME = .FALSE.
ELSE
! Prints " 13" if compiled with -qsave or -qsave=all
! Prints " 13" if compiled with -qsave=defaultinit
! Prints " 17" if compiled with -qnosave
PRINT *, LOCAL_STRUCT%j
! Prints " 19" if compiled with -qsave or -qsave=all
! Value of LOCAL_VAR is undefined otherwise
PRINT *, LOCAL_VAR
END IF
END SUBROUTINE SUB

```

**Example 3: The last occurrence of default initialization in a map declaration within a union structure becomes the final initialization of the component**

```

structure /st/
union
map
    integer i /3/, j /4/
    union
    map
        integer k /8/, l /9/
    end map
    end union
end map
map
    integer a, b
    union
    map
        integer c /21/
    end map
end map

```

```

        end union
    end map
end union
end structure
record /st/ R
print *, R.i, R.j, R.k, R.l      ! Prints "3 4 21 9"
print *, R.a, R.b, R.c        ! Prints "3 4 21"
end

```

**Example 4: The following program is compiled with `-qintsize=4` and `-qalign=struct=packed`, the components in the union MAP are aligned and packed**

```

structure /s/
  union
    map
      integer*2 i /z'1a1a'/, %FILL, j /z'2b2b'/
    end map
    map
      integer m, n
    end map
  end union
end structure
record /s/ r

print '(2z6.4)', r.i, r.j      ! Prints "1A1A 2B2B"
print '(2z10.8)', r.m, r.n    ! Prints "1A1A0000 2B2B0000" however
                              ! the two bytes in the lower order are
                              ! not guaranteed.

r.m = z'abc00cba'             ! Components are initialized by
                              ! assignment statements.

r.n = z'02344320'

print '(2z10.8)', r.m, r.n    ! Prints "ABC00CBA 02344320"
print '(2z6.4)', r.i, r.j     ! Prints "ABC0 0234"
end

```

End of IBM Extension

---

## Appendix A. Compatibility across standards

This information is provided for the benefit of users of earlier language standards, such as FORTRAN 77, who are unfamiliar with more current language standards like Fortran 90, Fortran 95, or Fortran 2003, or with XL Fortran.

Except as noted here, the Fortran 90, Fortran 95, and Fortran 2003 standards are upward-compatible extensions to the preceding Fortran International Standard, ISO 1539-1:1980, informally referred to as FORTRAN 77. Any standard-conforming FORTRAN 77 program remains standard-conforming under the Fortran 90 standard, except as noted under item 4 below regarding intrinsic procedures. Any standard-conforming FORTRAN 77 program remains standard-conforming under the Fortran 95 or Fortran 2003 standard, as long as none of the deleted features are used in the program, except as noted under item 4 below regarding intrinsic procedures. The Fortran 90, Fortran 95, and Fortran 2003 standards restrict the behavior of some features that are processor-dependent in FORTRAN 77. Therefore, a standard-conforming FORTRAN 77 program that uses one of these processor-dependent features may have a different interpretation under the Fortran 90, Fortran 95, or Fortran 2003 standard, yet remain a standard-conforming program. The following FORTRAN 77 features have different interpretations in Fortran 90, Fortran 95, and Fortran 2003:

1. FORTRAN 77 permitted a processor to supply more precision derived from a real constant than can be contained in a real datum when the constant is used to initialize a **DOUBLE PRECISION** data object in a **DATA** statement. Fortran 90, Fortran 95, and Fortran 2003 do not permit this processor-dependent option. Previous releases of XL Fortran have been consistent with the Fortran 90 and Fortran 95 behavior.
2. If a named variable that is not in a common block is initialized in a **DATA** statement and does not have the **SAVE** attribute specified, FORTRAN 77 left its **SAVE** attribute processor-dependent. The Fortran 90, Fortran 95, and Fortran 2003 standards specify that this named variable has the **SAVE** attribute. Previous releases of XL Fortran have been consistent with the Fortran 90 and Fortran 95 behavior.
3. FORTRAN 77 required that the number of characters required by the input list must be less than or equal to the number of characters in the record during formatted input. The Fortran 90, Fortran 95, and Fortran 2003 standards specify that the input record is logically padded with blanks if there are not enough characters in the record, unless the **PAD='NO'** specifier is indicated in an appropriate **OPEN** statement. With XL Fortran, the input record is not padded with blanks if the **noblankpad** suboption of the **-qxlf77** compiler option is specified.
4. The Fortran 90, Fortran 95, and Fortran 2003 standards have more intrinsic functions than FORTRAN 77, in addition to a few intrinsic subroutines. Therefore, a standard-conforming FORTRAN 77 program may have a different interpretation under Fortran 90, Fortran 95, or Fortran 2003 if it invokes a procedure having the same name as one of the new standard intrinsic procedures, unless that procedure is specified in an **EXTERNAL** statement. With XL Fortran, the **-qextern** compiler option also treats specified names as if they appear in an **EXTERNAL** statement.
5. In Fortran 95 and Fortran 2003, for some edit descriptors, a value of 0 for a list item in a formatted output statement will be formatted differently. In addition,

the Fortran 95 standard, unlike the FORTRAN 77 standard, specifies how rounding of values will affect the output field form. Therefore, for certain combinations of values and edit descriptors, FORTRAN 77 processors may produce a different output form than Fortran 95 processors.

6. Fortran 95 and Fortran 2003 allow a processor to distinguish between a positive and a negative real zero, whereas Fortran 90 did not. Fortran 95 changes the behavior of the **SIGN** intrinsic function when the second argument is negative real zero.
7. To distinguish between the Fortran 95 and Fortran 2003 interpretations of signed zeros in the **ATAN2(Y,X)**, **LOG(X)** and **SQRT(X)** intrinsics, the **-qxf2003=signedzerointr** suboption must be used in conjunction with the **-qxf90=signedzero** option. For the **xf95** invocation only **-qxf2003=signedzerointr** needs to be specified since **-qxf90=signedzero** is on by default. For **xf2003** none of the options need to be specified since both are on by default. For the **xf90**, **xf77** and **xf** invocations, both options must be specified in order to have Fortran 2003 standard behaviour.

---

## Fortran 90 compatibility

Except as noted here, the Fortran 95 standard is an upward-compatible extension to the preceding Fortran International Standard, ISO/IEC 1539-1:1991, informally referred to as Fortran 90. A standard conforming Fortran 90 program that does not use any of the features deleted from the Fortran 95 standard, is a standard conforming Fortran 95 program, as well. The Fortran 90 features that have been deleted from the Fortran 95 standard are the following:

- **ASSIGN** and assigned **GO TO** statements
- **PAUSE** statement
- **DO** control variables and expressions of type real
- **H** edit descriptor
- Branching to an **END IF** statement from outside the **IF** block

Fortran 95 allows a processor to distinguish between a positive and a negative real zero, whereas Fortran 90 did not. Fortran 95 changes the behavior of the **SIGN** intrinsic function when the second argument is negative real zero.

More intrinsic functions appear in the Fortran 95 standard than in the Fortran 90 standard. Therefore, a program that conforms to the Fortran 90 standard may have a different interpretation under the Fortran 95 standard. The different interpretation of the program in Fortran 95 will only occur if the program invokes a procedure that has the same name as one of the new standard intrinsic procedures, unless that procedure is specified in an **EXTERNAL** statement or with an interface body.

---

## Obsolescent features

As the Fortran language evolves, it is only natural that the functionality of some older features are better handled by newer features geared toward today's programming needs. At the same time, the considerable investment in legacy Fortran code suggests that it would be insensitive to customer needs to decommit any Fortran 90 or FORTRAN 77 features at this time. For this reason, XL Fortran is fully upward compatible with the Fortran 90 and FORTRAN 77 standards. Fortran 95 has removed features that were part of both the Fortran 90 and FORTRAN 77 language standards. However, functionality has not been removed from Fortran 95 as efficient alternatives to the features deleted do exist.

Fortran 95 defines two categories of outmoded features: deleted features and obsolescent features. Deleted features are Fortran 90 or FORTRAN 77 features that are considered to be largely unused and so are not supported in Fortran 95.

Obsolescent features are FORTRAN 77 features that are still frequently used today but whose use can be better delivered by newer features and methods. Although obsolescent features are, by definition, supported in the Fortran 95 standard, some of them may be marked as deleted in the next Fortran standard. Although a processor may still support deleted features as extensions to the language, you may want to take steps now to modify your existing code to use better methods.

Fortran 90 indicates the following FORTRAN 77 features are obsolescent:

- **Arithmetic IF**

*Recommended method:* Use the logical **IF** statement, **IF** construct, or **CASE** construct.

- **DO** control variables and expressions of type real

*Recommended method:* Use variables and expression of type integer.

- **PAUSE** statement

*Recommended method:* Use the **READ** statement.

- Alternate return specifiers

*Recommended method:* Evaluate a return code in a **CASE** construct or a computed **GO TO** statement on return from the procedure.

```
! FORTRAN 77

CALL SUB(A,B,C,*10,*20,*30)

! Fortran 90

CALL SUB(A,B,C,RET_CODE)
SELECT CASE (RET_CODE)
  CASE (1)
    ⋮
  CASE (2)
    ⋮
  CASE (3)
    ⋮
END SELECT
```

- **ASSIGN** and assigned **GO TO** statements

*Recommended method:* Use internal procedures.

- Branching to an **END IF** statement from outside the **IF** block

*Recommended method:* Branch to the statement that follows the **END IF** statement.

- Shared loop termination and termination on a statement other than **END DO** or **CONTINUE**

*Recommended method:* Use an **END DO** or **CONTINUE** statement to terminate each loop.

- **H** edit descriptor

*Recommended method:* Use the character constant edit descriptor.

Fortran 95 and Fortran 2003 indicate the following FORTRAN 77 features as obsolescent:

- **Arithmetic IF**

*Recommended method:* Use the logical **IF** statement, **IF** construct, or **CASE** construct.

- Alternate return specifiers

*Recommended method:* Evaluate a return code in a **CASE** construct or a computed **GO TO** statement on return from the procedure.

```
! FORTRAN 77

CALL SUB(A,B,C,*10,*20,*30)

! Fortran 90

CALL SUB(A,B,C,RET_CODE)
SELECT CASE (RET_CODE)
CASE (1)

  ⋮
CASE (2)

  ⋮
CASE (3)

  ⋮
END SELECT
```

- Shared loop termination and termination on a statement other than **END DO** or **CONTINUE**

*Recommended method:* Use an **END DO** or **CONTINUE** statement to terminate each loop.

- Statement functions
- **DATA** statements in executables
- Assumed length character functions
- Fixed source form
- **CHARACTER\*** form of declaration

---

## Deleted features

Fortran 2003 and Fortran 95 indicates that the following Fortran 90 and FORTRAN 77 features have been deleted:

- **ASSIGN** and assigned **GO TO** statements
- **PAUSE** statement
- **DO** control variables and expressions of type real
- **H** edit descriptor
- Branching to an **END IF** statement from outside the **IF** block

## Appendix B. ASCII and EBCDIC character sets

XL Fortran uses the ASCII character set as its collating sequence.

This table lists the standard ASCII characters in numerical order with the corresponding decimal and hexadecimal values. For convenience in working with programs that use EBCDIC character values, the corresponding information for EBCDIC characters is also included. The table indicates the control characters with “Ctrl-” notation. For example, the horizontal tab (HT) appears as “Ctrl-I”, which you enter by simultaneously pressing the Ctrl key and I key.

*Table 39. Equivalent characters in the ASCII and EBCDIC character sets*

Decimal Value	Hex Value	Control Character	ASCII Symbol	Meaning	EBCDIC Symbol	Meaning
0	00	Ctrl-@	NUL	null	NUL	null
1	01	Ctrl-A	SOH	start of heading	SOH	start of heading
2	02	Ctrl-B	STX	start of text	STX	start of text
3	03	Ctrl-C	ETX	end of text	ETX	end of text
4	04	Ctrl-D	EOT	end of transmission	SEL	select
5	05	Ctrl-E	ENQ	enquiry	HT	horizontal tab
6	06	Ctrl-F	ACK	acknowledge	RNL	required new-line
7	07	Ctrl-G	BEL	bell	DEL	delete
8	08	Ctrl-H	BS	backspace	GE	graphic escape
9	09	Ctrl-I	HT	horizontal tab	SPS	superscript
10	0A	Ctrl-J	LF	line feed	RPT	repeat
11	0B	Ctrl-K	VT	vertical tab	VT	vertical tab
12	0C	Ctrl-L	FF	form feed	FF	form feed
13	0D	Ctrl-M	CR	carriage return	CR	carriage return
14	0E	Ctrl-N	SO	shift out	SO	shift out
15	0F	Ctrl-O	SI	shift in	SI	shift in
16	10	Ctrl-P	DLE	data link escape	DLE	data link escape
17	11	Ctrl-Q	DC1	device control 1	DC1	device control 1
18	12	Ctrl-R	DC2	device control 2	DC2	device control 2
19	13	Ctrl-S	DC3	device control 3	DC3	device control 3
20	14	Ctrl-T	DC4	device control 4	RES/ENP	restore/enable presentation
21	15	Ctrl-U	NAK	negative acknowledge	NL	new-line
22	16	Ctrl-V	SYN	synchronous idle	BS	backspace
23	17	Ctrl-W	ETB	end of transmission block	POC	program-operator communications
24	18	Ctrl-X	CAN	cancel	CAN	cancel
25	19	Ctrl-Y	EM	end of medium	EM	end of medium
26	1A	Ctrl-Z	SUB	substitute	UBS	unit backspace
27	1B	Ctrl-[	ESC	escape	CU1	customer use 1
28	1C	Ctrl-\	FS	file separator	IFS	interchange file separator
29	1D	Ctrl-]	GS	group separator	IGS	interchange group separator

Table 39. Equivalent characters in the ASCII and EBCDIC character sets (continued)

Decimal Value	Hex Value	Control Character	ASCII Symbol	Meaning	EBCDIC Symbol	Meaning
30	1E	Ctrl-^	RS	record separator	IRS	interchange record separator
31	1F	Ctrl-_	US	unit separator	IUS/ITB	interchange unit separator / intermediate transmission block
32	20		SP™	space	DS	digit select
33	21		!	exclamation mark	SOS	start of significance
34	22		"	straight double quotation mark	FS	field separator
35	23		#	number sign	WUS	word underscore
36	24		\$	dollar sign	BYP/INP	bypass/inhibit presentation
37	25		%	percent sign	LF	line feed
38	26		&	ampersand	ETB	end of transmission block
39	27		'	apostrophe	ESC	escape
40	28		(	left parenthesis	SA	set attribute
41	29		)	right parenthesis		
42	2A		*	asterisk	SM/SW	set model switch
43	2B		+	addition sign	CSP	control sequence prefix
44	2C		,	comma	MFA	modify field attribute
45	2D		-	subtraction sign	ENQ	enquiry
46	2E		.	period	ACK	acknowledge
47	2F		/	right slash	BEL	bell
48	30		0			
49	31		1			
50	32		2		SYN	synchronous idle
51	33		3		IR	index return
52	34		4		PP	presentation position
53	35		5		TRN	
54	36		6		NBS	numeric backspace
55	37		7		EOT	end of transmission
56	38		8		SBS	subscript
57	39		9		IT	indent tab
58	3A		:	colon	RFF	required form feed
59	3B		;	semicolon	CU3	customer use 3
60	3C		<	less than	DC4	device control 4
61	3D		=	equal	NAK	negative acknowledge
62	3E		>	greater than		
63	3F		?	question mark	SUB	substitute
64	40		@	at symbol	SP	space
65	41		A			
66	42		B			
67	43		C			
68	44		D			
69	45		E			
70	46		F			



Table 39. Equivalent characters in the ASCII and EBCDIC character sets (continued)

Decimal Value	Hex Value	Control Character	ASCII Symbol	Meaning	EBCDIC Symbol	Meaning
71	47		G			
72	48		H			
73	49		I			
74	4A		J		¢	cent
75	4B		K		.	period
76	4C		L		<	less than
77	4D		M		(	left parenthesis
78	4E		N		+	addition sign
79	4F		O			logical or
80	50		P		&	ampersand
81	51		Q			
82	52		R			
83	53		S			
84	54		T			
85	55		U			
86	56		V			
87	57		W			
88	58		X			
89	59		Y			
90	5A		Z		!	exclamation mark
91	5B		[	left bracket	\$	dollar sign
92	5C		\	left slash	*	asterisk
93	5D		]	right bracket	)	right parenthesis
94	5E		^	hat, circumflex	;	semicolon
95	5F		_	underscore	¬	logical not
96	60		`	grave	-	subtraction sign
97	61		a		/	right slash
98	62		b			
99	63		c			
100	64		d			
101	65		e			
102	66		f			
103	67		g			
104	68		h			
105	69		i			
106	6A		j		‡	split vertical bar
107	6B		k		,	comma
108	6C		l		%	percent sign
109	6D		m		_	underscore
110	6E		n		>	greater than
111	6F		o		?	question mark
112	70		p			
113	71		q			
114	72		r			

Table 39. Equivalent characters in the ASCII and EBCDIC character sets (continued)

Decimal Value	Hex Value	Control Character	ASCII Symbol	Meaning	EBCDIC Symbol	Meaning
115	73		s			
116	74		t			
117	75		u			
118	76		v			
119	77		w			
120	78		x			
121	79		y		`	grave
122	7A		z		:	colon
123	7B		{	left brace	#	numbersign
124	7C			logical or	@	at symbol
125	7D		}	right brace	'	apostrophe
126	7E		~	similar, tilde	=	equal
127	7F		DEL	delete	"	straight double quotation mark
128	80					
129	81				a	
130	82				b	
131	83				c	
132	84				d	
133	85				e	
134	86				f	
135	87				g	
136	88				h	
137	89				i	
138	8A					
139	8B					
140	8C					
141	8D					
142	8E					
143	8F					
144	90					
145	91				j	
146	92				k	
147	93				l	
148	94				m	
149	95				n	
150	96				o	
151	97				p	
152	98				q	
153	99				r	
154	9A					
155	9B					
156	9C					
157	9D					

Table 39. Equivalent characters in the ASCII and EBCDIC character sets (continued)

Decimal Value	Hex Value	Control Character	ASCII Symbol	Meaning	EBCDIC Symbol	Meaning
158	9E					
159	9F					
160	A0					
161	A1				~	similar, tilde
162	A2				s	
163	A3				t	
164	A4				u	
165	A5				v	
166	A6				w	
167	A7				x	
168	A8				y	
169	A9				z	
170	AA					
171	AB					
172	AC					
173	AD					
174	AE					
175	AF					
176	B0					
177	B1					
178	B2					
179	B3					
180	B4					
181	B5					
182	B6					
183	B7					
184	B8					
185	B9					
186	BA					
187	BB					
188	BC					
189	BD					
190	BE					
191	BF					
192	C0				{	left brace
193	C1				A	
194	C2				B	
195	C3				C	
196	C4				D	
197	C5				E	
198	C6				F	
199	C7				G	
200	C8				H	
201	C9				I	

Table 39. Equivalent characters in the ASCII and EBCDIC character sets (continued)

Decimal Value	Hex Value	Control Character	ASCII Symbol	Meaning	EBCDIC Symbol	Meaning
202	CA					
203	CB					
204	CC					
205	CD					
206	CE					
207	CF					
208	D0				}	right brace
209	D1				J	
210	D2				K	
211	D3				L	
212	D4				M	
213	D5				N	
214	D6				O	
215	D7				P	
216	D8				Q	
217	D9				R	
218	DA					
219	DB					
220	DC					
221	DD					
222	DE					
223	DF					
224	E0				\	left slash
225	E1					
226	E2				S	
227	E3				T	
228	E4				U	
229	E5				V	
230	E6				W	
231	E7				X	
232	E8				Y	
233	E9				Z	
234	EA					
235	EB					
236	EC					
237	ED					
238	EE					
239	EF					
240	F0				0	
241	F1				1	
242	F2				2	
243	F3				3	
244	F4				4	
245	F5				5	

Table 39. Equivalent characters in the ASCII and EBCDIC character sets (continued)

Decimal Value	Hex Value	Control Character	ASCII Symbol	Meaning	EBCDIC Symbol	Meaning
246	F6				6	
247	F7				7	
248	F8				8	
249	F9				9	
250	FA					vertical line
251	FB					
252	FC					
253	FD					
254	FE					
255	FF				EO	eight ones



---

## Notices

This information was developed for products and services offered in the U.S.A. IBM may not offer the products, services, or features discussed in this document in other countries. Consult your local IBM representative for information on the products and services currently available in your area. Any reference to an IBM product, program, or service is not intended to state or imply that only that IBM product, program, or service may be used. Any functionally equivalent product, program, or service that does not infringe any IBM intellectual property right may be used instead. However, it is the user's responsibility to evaluate and verify the operation of any non-IBM product, program, or service.

IBM may have patents or pending patent applications covering subject matter described in this document. The furnishing of this document does not give you any license to these patents. You can send license inquiries, in writing, to:

IBM Director of Licensing  
IBM Corporation  
North Castle Drive  
Armonk, NY 10504-1785  
U.S.A.

For license inquiries regarding double-byte (DBCS) information, contact the IBM Intellectual Property Department in your country or send inquiries, in writing, to:

IBM World Trade Asia Corporation  
Licensing  
2-31 Roppongi 3-chome, Minato-ku  
Tokyo 106, Japan

**The following paragraph does not apply to the United Kingdom or any other country where such provisions are inconsistent with local law:**

INTERNATIONAL BUSINESS MACHINES CORPORATION PROVIDES THIS PUBLICATION "AS IS" WITHOUT WARRANTY OF ANY KIND, EITHER EXPRESS OR IMPLIED, INCLUDING, BUT NOT LIMITED TO, THE IMPLIED WARRANTIES OF NON-INFRINGEMENT, MERCHANTABILITY OR FITNESS FOR A PARTICULAR PURPOSE. Some states do not allow disclaimer of express or implied warranties in certain transactions, therefore, this statement may not apply to you.

This information could include technical inaccuracies or typographical errors. Changes are periodically made to the information herein; these changes will be incorporated in new editions of the publication. IBM may make improvements and/or changes in the product(s) and/or the program(s) described in this publication at any time without notice.

Any references in this information to non-IBM Web sites are provided for convenience only and do not in any manner serve as an endorsement of those Web sites. The materials at those Web sites are not part of the materials for this IBM product and use of those Web sites is at your own risk.

IBM may use or distribute any of the information you supply in any way it believes appropriate without incurring any obligation to you.

Licensees of this program who wish to have information about it for the purpose of enabling: (i) the exchange of information between independently created programs and other programs (including this one) and (ii) the mutual use of the information which has been exchanged, should contact:

Lab Director  
IBM Canada Ltd. Laboratory  
8200 Warden Avenue  
Markham, Ontario L6G 1C7  
Canada

Such information may be available, subject to appropriate terms and conditions, including in some cases, payment of a fee.

The licensed program described in this document and all licensed material available for it are provided by IBM under terms of the IBM Customer Agreement, IBM International Program License Agreement or any equivalent agreement between us.

Any performance data contained herein was determined in a controlled environment. Therefore, the results obtained in other operating environments may vary significantly. Some measurements may have been made on development-level systems and there is no guarantee that these measurements will be the same on generally available systems. Furthermore, some measurements may have been estimated through extrapolation. Actual results may vary. Users of this document should verify the applicable data for their specific environment.

Information concerning non-IBM products was obtained from the suppliers of those products, their published announcements or other publicly available sources. IBM has not tested those products and cannot confirm the accuracy of performance, compatibility or any other claims related to non-IBM products. Questions on the capabilities of non-IBM products should be addressed to the suppliers of those products.

All statements regarding IBM's future direction or intent are subject to change or withdrawal without notice, and represent goals and objectives only.

This information contains examples of data and reports used in daily business operations. To illustrate them as completely as possible, the examples include the names of individuals, companies, brands, and products. All of these names are fictitious and any similarity to the names and addresses used by an actual business enterprise is entirely coincidental.

#### COPYRIGHT LICENSE:

This information contains sample application programs in source language, which illustrates programming techniques on various operating platforms. You may copy, modify, and distribute these sample programs in any form without payment to IBM, for the purposes of developing, using, marketing or distributing application programs conforming to the application programming interface for the operating platform for which the sample programs are written. These examples have not been thoroughly tested under all conditions. IBM, therefore, cannot guarantee or imply reliability, serviceability, or function of these programs. You may copy, modify, and distribute these sample programs in any form without payment to IBM for the purposes of developing, using, marketing, or distributing application programs conforming to IBM's application programming interfaces.



Each copy or any portion of these sample programs or any derivative work, must include a copyright notice as follows:

© (your company name) (year). Portions of this code are derived from IBM Corp. Sample Programs. © Copyright IBM Corp. 1998, 2007. All rights reserved.

This software and documentation are based in part on the Fourth Berkeley Software Distribution under license from the Regents of the University of California. We acknowledge the following institution for its role in this product's development: the Electrical Engineering and Computer Sciences Department at the Berkeley campus.

---

## Trademarks and service marks

Company, product, or service names identified in the text may be trademarks or service marks of IBM or other companies. Information on the trademarks of International Business Machines Corporation in the United States, other countries, or both is located at <http://www.ibm.com/legal/copytrade.shtml>.

Microsoft and Windows are trademarks of Microsoft Corporation in the United States, other countries, or both.

Intel is a trademark or registered trademark of Intel Corporation or its subsidiaries in the United States and other countries.

UNIX is a registered trademark of The Open Group in the United States and other countries.

Linux is a registered trademark of Linus Torvalds in the United States, other countries, or both.

Other company, product, and service names may be trademarks or service marks of others.



---

## Glossary

This glossary defines terms that are commonly used in this document. It includes definitions developed by the American National Standards Institute (ANSI) and entries from the *IBM Terminology* web site.

### A

**abstract interface.** An **ABSTRACT INTERFACE** consists of procedure characteristics and names of dummy arguments. Used to declare the interfaces for procedures and deferred bindings.

**abstract type.** A type that has the **ABSTRACT** attribute. A nonpolymorphic object cannot be declared to be of abstract type. A polymorphic object cannot be constructed or allocated to have a dynamic type that is abstract.

**active processor.** See *online processor*.

**actual argument.** An expression, variable, procedure, or alternate return specifier that is specified in a procedure reference.

**alias.** A single piece of storage that can be accessed through more than a single name. Each name is an alias for that storage.

**alphabetic character.** A letter or other symbol, excluding digits, used in a language. Usually the uppercase and lowercase letters A through Z plus other special symbols (such as \$ and \_) allowed by a particular language.

**alphanumeric.** Pertaining to a character set that contains letters, digits, and usually other characters, such as punctuation marks and mathematical symbols.

**American National Standard Code for Information Interchange.** See *ASCII*.

**argument.** An expression that is passed to a function or subroutine. See also *actual argument*, *dummy argument*.

**argument association.** The relationship between an actual argument and a dummy argument during the invocation of a procedure.

**arithmetic constant.** A constant of type integer, real, or complex.

**arithmetic expression.** One or more arithmetic operators and arithmetic primaries, the evaluation of which produces a numeric value. An arithmetic expression can be an unsigned arithmetic constant, the

name of an arithmetic constant, or a reference to an arithmetic variable, function reference, or a combination of such primaries formed by using arithmetic operators and parentheses.

**arithmetic operator.** A symbol that directs the performance of an arithmetic operation. The intrinsic arithmetic operators are:

+	addition
-	subtraction
*	multiplication
/	division
**	exponentiation

**array.** An entity that contains an ordered group of scalar data. All objects in an array have the same data type and type parameters.

**array declarator.** The part of a statement that describes an array used in a program unit. It indicates the name of the array, the number of dimensions it contains, and the size of each dimension.

**array element.** A single data item in an array, identified by the array name and one or more subscripts. See also *subscript*.

**array name.** The name of an ordered set of data items.

**array section.** A subobject that is an array and is not a structure component.

**ASCII.** The standard code, using a coded character set consisting of 7-bit coded characters (8-bits including parity check), that is used for information interchange among data processing systems, data communication systems, and associated equipment. The ASCII set consists of control characters and graphic characters. See also *Unicode*.

**asynchronous.** Pertaining to events that are not synchronized in time or do not occur in regular or predictable time intervals.

**assignment statement.** An executable statement that defines or redefines a variable based on the result of expression evaluation.

**associate name.** The name by which a selector of a **SELECT TYPE** or **ASSOCIATE** construct is known within the construct.

**assumed-size array.** A dummy array whose size is assumed from the associated actual argument. Its last upper bound is specified by an asterisk.

**attribute.** A property of a data object that may be specified in a type declaration statement, attribute specification statement, or through a default setting.

**automatic parallelization.** The process by which the compiler attempts to parallelize both explicitly coded **DO** loops and **DO** loops generated by the compiler for array language.

## B

**base type.** An extensible type that is not an extension of another type.

**binary constant.** A constant that is made of one or more binary digits (0 and 1).

**bind.** To relate an identifier to another object in a program; for example, to relate an identifier to a value, an address or another identifier, or to associate formal parameters and actual parameters.

**binding label.** A value of type default character that uniquely identifies how a variable, common block, subroutine, or function is known to a companion processor.

**blank common.** An unnamed common block.

**block data subprogram.** A subprogram headed by a **BLOCK DATA** statement and used to initialize variables in named common blocks.

**bounds\_remapping.** Allows a user to view a flat, rank-1 array as a multi-dimensional array.

**bss storage.** Uninitialized static storage.

**busy-wait.** The state in which a thread keeps executing in a tight loop looking for more work once it has completed all of its work and there is no new work to do.

**byte constant.** A named constant that is of type byte.

**byte type.** A data type representing a one-byte storage area that can be used wherever a **LOGICAL(1)**, **CHARACTER(1)**, or **INTEGER(1)** can be used.

## C

**character constant.** A string of one or more alphabetic characters enclosed in apostrophes or double quotation marks.

**character expression.** A character object, a character-valued function reference, or a sequence of them separated by the concatenation operator, with optional parentheses.

**character operator.** A symbol that represents an operation, such as concatenation (`//`), to be performed on character data.

**character set.** All the valid characters for a programming language or for a computer system.

**character string.** A sequence of consecutive characters.

**character substring.** A contiguous portion of a character string.

**character type.** A data type that consists of alphanumeric characters. See also *data type*.

**chunk.** A subset of consecutive loop iterations.

**class.** A set of types comprised of a base type and all types extended from it.

**collating sequence.** The sequence in which the characters are ordered for the purpose of sorting, merging, comparing, and processing indexed data sequentially.

**comment.** A language construct for the inclusion of text in a program that has no effect on the execution of the program.

**common block.** A storage area that may be referred to by a calling program and one or more subprograms.

**compile.** To translate a source program into an executable program (an object program).

**compiler comment directive.** A line in source code that is not a Fortran statement but is recognized and acted on by the compiler.

**compiler directive.** Source code that controls what XL Fortran does rather than what the user program does.

**complex constant.** An ordered pair of real or integer constants separated by a comma and enclosed in parentheses. The first constant of the pair is the real part of the complex number; the second is the imaginary part.

**complex number.** A number consisting of an ordered pair of real numbers, expressible in the form  $a+bi$ , where  $a$  and  $b$  are real numbers and  $i$  squared equals  $-1$ .

**complex type.** A data type that represents the values of complex numbers. The value is expressed as an ordered pair of real data items separated by a comma and enclosed in parentheses. The first item represents the real part of the complex number; the second represents the imaginary part.

**component.** A constituent of a derived type.

**component order.** The ordering of the components of a derived type that is used for intrinsic formatted input/output and for structure constructors.

**conform.** To adhere to a prevailing standard. An executable program conforms to the Fortran 95 Standard if it uses only those forms and relationships described therein and if the executable program has an interpretation according to the Fortran 95 Standard. A program unit conforms to the Fortran 95 Standard if it can be included in an executable program in a manner that allows the executable program to be standard-conforming. A processor conforms to the standard if it executes standard-conforming programs in a manner that fulfills the interpretations prescribed in the standard.

**connected unit.** In XL Fortran, a unit that is connected to a file in one of three ways: explicitly via the **OPEN** statement to a named file, implicitly, or by preconnection.

**constant.** A data object with a value that does not change. The four classes of constants specify numbers (arithmetic), truth values (logical), character data (character), and typeless data (hexadecimal, octal, and binary). See also *variable*.

**construct.** A sequence of statements starting with a **SELECT CASE**, **DO**, **IF**, or **WHERE** statement, for example, and ending with the corresponding terminal statement.

**continuation line.** A line that continues a statement beyond its initial line.

**control statement.** A statement that is used to alter the continuous sequential invocation of statements; a control statement may be a conditional statement, such as **IF**, or an imperative statement, such as **STOP**.

## D

**data object.** A variable, constant, or subobject of a constant.

**data striping.** Spreading data across multiple storage devices so that I/O operations can be performed in parallel for better performance. Also known as *disk striping*.

**data transfer statement.** A **READ**, **WRITE**, or **PRINT** statement.

**data type.** The properties and internal representation that characterize data and functions. The intrinsic types are integer, real, complex, logical, and character. See also *intrinsic*.

**debug line.** Allowed only for fixed source form, a line containing source code that is to be used for debugging. Debug lines are defined by a **D** or **X** in

column 1. The handling of debug lines is controlled by the **-qdlines** and **-qxlines** compiler options.

**decimal symbol.** The symbol that separates the whole and fractional parts of a real number.

**declared type.** The type that a data entity is declared to have. May differ from the type during execution (the dynamic type) for polymorphic data entities.

**default initialization.** The initialization of an object with a value specified as part of a derived type definition.

**deferred binding .** A binding with the **DEFERRED** attribute. A deferred binding can only appear in an abstract type definition.

**definable variable.** A variable whose value can be changed by the appearance of its name or designator on the left of an assignment statement.

**delimiters.** A pair of parentheses or slashes (or both) used to enclose syntactic lists.

**denormalized number.** An IEEE number with a very small absolute value and lowered precision. A denormalized number is represented by a zero exponent and a non-zero fraction.

**derived type.** A type whose data have components, each of which is either of intrinsic type or of another derived type.

**digit.** A character that represents a nonnegative integer. For example, any of the numerals from 0 through 9.

**directive.** A type of comment that provides instructions and information to the compiler.

**disk striping.** See *data striping*.

**DO loop.** A range of statements invoked repetitively by a **DO** statement.

**DO variable.** A variable, specified in a **DO** statement, that is initialized or incremented prior to each occurrence of the statement or statements within a **DO** loop. It is used to control the number of times the statements within the range are executed.

**DOUBLE PRECISION constant.** A constant of type real with twice the precision of the default real precision.

**dummy argument.** An entity whose name appears in the parenthesized list following the procedure name in a **FUNCTION**, **SUBROUTINE**, **ENTRY**, or statement function statement.

**dynamic dimensioning.** The process of re-evaluating the bounds of an array each time the array is referenced.

**dynamic extent.** For a directive, the lexical extent of the directive and all subprograms called from within the lexical extent.

**dynamic type.** The type of a data entity during execution of a program. The dynamic type of a data entity that is not polymorphic is the same as its declared type.

## E

**edit descriptor.** An abbreviated keyword that controls the formatting of integer, real, or complex data.

**effective item .** A scalar object resulting from expanding an input/output list.

**elemental.** Pertaining to an intrinsic operation, procedure or assignment that is applied independently to elements of an array or corresponding elements of a set of conformable arrays and scalars.

**embedded blank.** A blank that is surrounded by any other characters.

**entity.** A general term for any of the following: a program unit, procedure, operator, interface block, common block, external unit, statement function, type, named variable, expression, component of a structure, named constant, statement label, construct, or namelist group.

**environment variable.** A variable that describes the operating environment of the process.

**executable program.** A program that can be executed as a self-contained procedure. It consists of a main program and, optionally, modules, subprograms and non-Fortran external procedures.

**executable statement.** A statement that causes an action to be taken by the program; for example, to perform a calculation, test conditions, or alter normal sequential execution.

**explicit initialization.** The initialization of an object with a value in a data statement initial value list, block data program unit, type declaration statement, or array constructor.

**explicit interface.** For a procedure referenced in a scoping unit, the property of being an internal procedure, module procedure, intrinsic procedure, external procedure that has an interface block, recursive procedure reference in its own scoping unit, or dummy procedure that has an interface block.

**expression.** A sequence of operands, operators, and parentheses. It may be a variable, a constant, or a function reference, or it may represent a computation.

**extended-precision constant.** A processor approximation to the value of a real number that occupies 16 consecutive bytes of storage.

**extended type.** An extensible type that is an extension of another type. A type that is declared with the **EXTENDS** attribute.

**extensible type.** A type from which new types may be derived using the **EXTENDS** attribute. A nonsequence type that does not have the **BIND** attribute.

**extension type.** A base type is an extension type of itself only. An extended type is an extension type of itself and of all types for which its parent type is an extension.

**external file.** A sequence of records on an input/output device. See also *internal file*.

**external name.** The name of a common block, subroutine, or other global procedure, which the linker uses to resolve references from one compilation unit to another.

**external procedure.** A procedure that is defined by an external subprogram or by a means other than Fortran.

## F

**field.** An area in a record used to contain a particular category of data.

**file.** A sequence of records. See also *external file*, *internal file*.

**file index.** See *i-node*.

**final subroutine.** A subroutine that is called automatically during finalization.

**finalizable.** A type that has final subroutines, or that has a finalizable component. An object of finalizable type.

**finalization.** The process of calling user-defined final subroutines immediately before destroying an object.

**floating-point number.** A real number represented by a pair of distinct numerals. The real number is the product of the fractional part, one of the numerals, and a value obtained by raising the implicit floating-point base to a power indicated by the second numeral.

**format.** (1) A defined arrangement of such things as characters, fields, and lines, usually used for displays, printouts, or files. (2) To arrange such things as characters, fields, and lines.

**formatted data.** Data that is transferred between main storage and an input/output device according to a specified format. See also *list-directed* and *unformatted record*.

**function.** A procedure that returns the value of a single variable or an object and usually has a single exit. See also *intrinsic procedure, subprogram*.

## G

**generic identifier.** A lexical token that appears in an **INTERFACE** statement and is associated with all the procedures in an interface block.

## H

**hard limit.** A system resource limit that can only be raised or lowered by using root authority, or cannot be altered because it is inherent in the system or operating environments's implementation. See also *soft limit*.

**hexadecimal.** Pertaining to a system of numbers to the base sixteen; hexadecimal digits range from 0 (zero) through 9 (nine) and A (ten) through F (fifteen).

**hexadecimal constant.** A constant, usually starting with special characters, that contains only hexadecimal digits.

**high order transformations.** A type of optimization that restructures loops and array language.

**Hollerith constant.** A string of any characters capable of representation by XL Fortran and preceded with *nH*, where *n* is the number of characters in the string.

**host.** A main program or subprogram that contains an internal procedure is called the host of the internal procedure. A module that contains a module procedure is called the host of the module procedure.

**host association.** The process by which an internal subprogram, module subprogram, or derived-type definition accesses the entities of its host.

## I

**IPA.** Interprocedural analysis, a type of optimization that allows optimizations to be performed across procedure boundaries and across calls to procedures in separate source files.

**implicit interface.** A procedure referenced in a scoping unit other than its own is said to have an implicit interface if the procedure is an external procedure that does not have an interface block, a dummy procedure that does not have an interface block, or a statement function.

**implied DO.** An indexing specification (similar to a **DO** statement, but without specifying the word **DO**) with a list of data elements, rather than a set of statements, as its range.

**infinity.** An IEEE number (positive or negative) created by overflow or division by zero. Infinity is represented by an exponent where all the bits are 1's, and a zero fraction.

**inherit.** To acquire from a parent. Components or procedure bindings of an extended type that are automatically acquired from its parent type without explicit declaration in the extended type are said to be inherited.

**inheritance association .** The relationship between the inherited components and the parent component in an extended type.

**i-node.** The internal structure that describes the individual files in the operating system. There is at least one i-node for each file. An i-node contains the node, type, owner, and location of a file. A table of i-nodes is stored near the beginning of a file system. Also known as *file index*.

**input/output (I/O).** Pertaining to either input or output, or both.

**input/output list.** A list of variables in an input or output statement specifying the data to be read or written. An output list can also contain a constant, an expression involving operators or function references, or an expression enclosed in parentheses.

**integer constant.** An optionally signed digit string that contains no decimal point.

**interface block.** A sequence of statements from an **INTERFACE** statement to its corresponding **END INTERFACE** statement.

**interface body.** A sequence of statements in an interface block from a **FUNCTION** or **SUBROUTINE** statement to its corresponding **END** statement.

**interference.** A situation in which two iterations within a **DO** loop have dependencies upon one another.

**internal file.** A sequence of records in internal storage. See also *external file*.

**interprocedural analysis.** See *IPA*.

**intrinsic.** Pertaining to types, operations, assignment statements, and procedures that are defined by Fortran language standards and can be used in any scoping unit without further definition or specification.

**intrinsic module.** A module that is provided by the compiler and is available to any program.

**intrinsic procedure.** A procedure that is provided by the compiler and is available to any program.

## K

**keyword.** (1) A statement keyword is a word that is part of the syntax of a statement (or directive) and may be used to identify the statement. (2) An argument keyword specifies the name of a dummy argument

**kind type parameter.** A parameter whose values label the available kinds of an intrinsic type.

## L

**lexical extent.** All of the code that appears directly within a directive construct.

**lexical token.** A sequence of characters with an indivisible interpretation.

**link-edit.** To create a loadable computer program by means of a linker.

**linker.** A program that resolves cross-references between separately compiled or assembled object modules and then assigns final addresses to create a single relocatable load module. If a single object module is linked, the linker simply makes it relocatable.

**list-directed.** A predefined input/output format that depends on the type, type parameters, and values of the entities in the data list.

**literal.** A symbol or a quantity in a source program that is itself data, rather than a reference to data.

**literal constant.** A lexical token that directly represents a scalar value of intrinsic type.

**load balancing.** An optimization strategy that aims at evenly distributing the work load among processors.

**logical constant.** A constant with a value of either true or false (or T or F).

**logical operator.** A symbol that represents an operation on logical expressions:

.NOT.	(logical negation)
.AND.	(logical conjunction)
.OR.	(logical union)
.EQV.	(logical equivalence)
.NEQV.	(logical nonequivalence)
.XOR.	(logical exclusive disjunction)

**loop.** A statement block that executes repeatedly.

## M

**\_main.** The default name given to a main program by the compiler if the main program was not named by the programmer.

**main program.** The first program unit to receive control when a program is run. See also *subprogram*.

**master thread.** The head process of a group of threads.

**module.** A program unit that contains or accesses definitions to be accessed by other program units.

**mutex.** A primitive object that provides mutual exclusion between threads. A mutex is used cooperatively between threads to ensure that only one of the cooperating threads is allowed to access shared data or run certain application code at a time.

## N

**NaN (not-a-number).** A symbolic entity encoded in floating-point format that does not correspond to a number. See also *quiet NaN*, *signaling NaN*.

**name.** A lexical token consisting of a letter followed by up to 249 alphanumeric characters (letters, digits, and underscores). Note that in FORTRAN 77, this was called a symbolic name.

**named common.** A separate, named common block consisting of variables.

**namelist group name.** The first parameter in the NAMELIST statement that names a list of names to be used in READ, WRITE, and PRINT statements.

**negative zero.** An IEEE representation where the exponent and fraction are both zero, but the sign bit is 1. Negative zero is treated as equal to positive zero.

**nest.** To incorporate a structure or structures of some kind into a structure of the same kind. For example, to nest one loop (the nested loop) within another loop (the nesting loop); to nest one subroutine (the nested subroutine) within another subroutine (the nesting subroutine).

**nonexecutable statement.** A statement that describes the characteristics of a program unit, data, editing information, or statement functions, but does not cause any action to be taken by the program.

**nonexisting file.** A file that does not physically exist on any accessible storage medium.

**normal.** A floating point number that is not denormal, infinity, or NaN.

**not-a-number.** See *NaN*.

**numeric constant.** A constant that expresses an integer, real, complex, or byte number.

**numeric storage unit.** The space occupied by a nonpointer scalar object of type default integer, default real, or default logical.



## O

**octal.** Pertaining to a system of numbers to the base eight; the octal digits range from 0 (zero) through 7 (seven).

**octal constant.** A constant that is made of octal digits.

**one-trip DO-loop.** A DO loop that is executed at least once, if reached, even if the iteration count is equal to 0. (This type of loop is from FORTRAN 66.)

**online processor.** In a multiprocessor machine, a processor that has been activated (brought online). The number of online processors is less than or equal to the number of physical processors actually installed in the machine. Also known as *active processor*.

**operator.** A specification of a particular computation involving one or two operands.

## P

**pad.** To fill unused positions in a field or character string with dummy data, usually zeros or blanks.

**paging space.** Disk storage for information that is resident in virtual memory but is not currently being accessed.

**parent component.** The component of an entity of extended type that corresponds to its inherited portion.

**parent type.** The extensible type from which an extended type is derived.

**passed-object dummy argument .** The dummy argument of a type-bound procedure or procedure pointer component that becomes associated with the object through which the procedure was invoked.

**PDF.** See *profile-directed feedback*.

**pointee array.** An explicit-shape or assumed-size array that is declared in an integer **POINTER** statement or other specification statement.

**pointer.** A variable that has the **POINTER** attribute. A pointer must not be referenced or defined unless it is pointer associated with a target. If it is an array, it does not have a shape unless it is pointer-associated.

**polymorphic.** Able to be of differing types during program execution. An object declared with the **CLASS** keyword is polymorphic.

**preconnected file.** A file that is connected to a unit at the beginning of execution of the executable program. Standard error, standard input, and standard output are preconnected files (units 0, 5 and 6, respectively).

**predefined convention.** The implied type and length specification of a data object, based on the initial

character of its name when no explicit specification is given. The initial characters I through N imply type integer of length 4; the initial characters A through H, O through Z, \$, and \_ imply type real of length 4.

**present.** A dummy argument is present in an instance of a subprogram if it is associated with an actual argument and the actual argument is a dummy argument that is present in the invoking procedure or is not a dummy argument of the invoking procedure.

**primary.** The simplest form of an expression: an object, array constructor, structure constructor, function reference, or expression enclosed in parentheses.

**procedure.** A computation that may be invoked during program execution. It may be a function or a subroutine. It may be an intrinsic procedure, an external procedure, a module procedure, an internal procedure, a dummy procedure, or a statement function. A subprogram may define more than one procedure if it contains **ENTRY** statements.

**procedure binding.** See type-bound procedure.

**procedure pointer.** A procedure entity that has the **EXTERNAL** and **POINTER** attributes. It can be pointer associated with an external procedure, a module procedure, a dummy procedure or another procedure pointer.

**profile-directed feedback (PDF).** A type of optimization that uses information collected during application execution to improve performance of conditional branches and in frequently executed sections of code.

**program unit.** A main program or subprogram.

**pure.** An attribute of a procedure that indicates there are no side effects.

## Q

**quiet NaN.** A NaN (not-a-number) value that does not signal an exception. The intent of a quiet NaN is to propagate a NaN result through subsequent computations. See also *NaN*, *signaling NaN*.

## R

**random access.** An access method in which records can be read from, written to, or removed from a file in any order. See also *sequential access*.

**rank.** The number of dimensions of an array.

**real constant.** A string of decimal digits that expresses a real number. A real constant must contain a decimal point, a decimal exponent, or both.

**record.** A sequence of values that is treated as a whole within a file.

**relational expression.** An expression that consists of an arithmetic or character expression, followed by a relational operator, followed by another arithmetic or character expression.

**relational operator.** The words or symbols used to express a relational condition or a relational expression:

.GT.	greater than
.GE.	greater than or equal to
.LT.	less than
.LE.	less than or equal to
.EQ.	equal to
.NE.	not equal to

**result variable.** The variable that returns the value of a function.

**return specifier.** An argument specified for a statement, such as CALL, that indicates to which statement label control should return, depending on the action specified by the subroutine in the RETURN statement.

## S

**scalar.** (1) A single datum that is not an array. (2) Not having the property of being an array.

**scale factor.** A number indicating the location of the decimal point in a real number (and, on input, if there is no exponent, the magnitude of the number).

**scope.** That part of an executable program within which a lexical token has a single interpretation.

**scope attribute.** That part of an executable program within which a lexical token has a single interpretation of a particular named property or entity.

**scoping unit.** (1) A derived-type definition. (2) An interface body, excluding any derived-type definitions and interface bodies contained within it. (3) A program unit or subprogram, excluding derived-type definitions, interface bodies, and subprograms contained within it.

**selector.** The object that is associated with the associate name in an ASSOCIATE construct.

**semantics.** The relationships of characters or groups of characters to their meanings, independent of the manner of their interpretation and use. See also *syntax*.

**sequential access.** An access method in which records are read from, written to, or removed from a file based on the logical order of the records in the file. See also *random access*.

**signaling NaN.** A NaN (not-a-number) value that signals an invalid operation exception whenever it appears as an operand. The intent of the signaling NaN

is to catch program errors, such as using an uninitialized variable. See also *NaN*, *quiet NaN*.

**sleep.** The state in which a thread completely suspends execution until another thread signals it that there is work to do.

**SMP.** See *symmetric multiprocessing*.

**soft limit.** A system resource limit that is currently in effect for a process. The value of a soft limit can be raised or lowered by a process, without requiring root authority. The soft limit for a resource cannot be raised above the setting of the hard limit. See also *hard limit*.

**spill space.** The stack space reserved in each subprogram in case there are too many variables to hold in registers and the program needs temporary storage for register contents.

**specification statement.** A statement that provides information about the data used in the source program. The statement could also supply information to allocate data storage.

**stanza.** A group of lines in a file that together have a common function or define a part of the system. Stanzas are usually separated by blank lines or colons, and each stanza has a name.

**statement.** A language construct that represents a step in a sequence of actions or a set of declarations. Statements fall into two broad classes: executable and nonexecutable.

**statement function.** A name, followed by a list of dummy arguments, that is equated with an intrinsic or derived-type expression, and that can be used as a substitute for the expression throughout the program.

**statement label.** A number made up of one to five digits that is used to identify a statement. Statement labels can be used to transfer control, to define the range of a DO, or to refer to a FORMAT statement.

**storage association.** The relationship between two storage sequences if a storage unit of one is the same as a storage unit of the other.

**structure.** A scalar data object of derived type.

**structure component.** The part of a data object of derived-type corresponding to a component of its type.

**subject.** A portion of a named data object that may be referenced or defined independently of other portions. It can be an array element, array section, structure component, or substring.

**subprogram.** A function subprogram or a subroutine subprogram. Note that in FORTRAN 77, a block data program unit was called a subprogram. See also *main program*.

**subroutine.** A procedure that is invoked by a **CALL** statement or defined assignment statement.

**subscript.** A subscript quantity or set of subscript quantities enclosed in parentheses and used with an array name to identify a particular array element.

**substring.** A contiguous portion of a scalar character string. (Although an array section can specify a substring selector, the result is not a substring.)

**symmetric multiprocessing (SMP).** A system in which functionally-identical multiple processors are used in parallel, providing simple and efficient load-balancing.

**synchronous.** Pertaining to an operation that occurs regularly or predictably with regard to the occurrence of a specified event in another process.

**syntax.** The rules for the construction of a statement. See also *semantics*.

## T

**target.** A named data object specified to have the **TARGET** attribute, a data object created by an **ALLOCATE** statement for a pointer, or a subobject of such an object.

**thread.** A stream of computer instructions that is in control of a process. A multithread process begins with one stream of instructions (one thread) and may later create other instruction streams to perform tasks.

**thread-visible variable.** A variable that can be accessed by more than one thread.

**time slice.** An interval of time on the processing unit allocated for use in performing a task. After the interval has expired, processing unit time is allocated to another task, so a task cannot monopolize processing unit time beyond a fixed limit.

**token.** In a programming language, a character string, in a particular format, that has some defined significance.

**trigger constant.** A sequence of characters that identifies comment lines as compiler comment directives.

**procedure.** A procedure binding in a type definition. The procedure may be referenced by the binding-name via any object of that dynamic type, as a defined operator, by defined assignment, or as part of the finalization process.

**type compatible.** All entities are type compatible with other entities of the same type. Unlimited polymorphic entities are type compatible with all entities; other polymorphic entities are type compatible with entities whose dynamic type is an extension type of the polymorphic entity's declared type.

**type declaration statement.** A statement that specifies the type, length, and attributes of an object or function. Objects can be assigned initial values.

**type parameter.** A parameter of a data type. **KIND** and **LEN** are the type parameters of intrinsic types.

## U

**unformatted record.** A record that is transmitted unchanged between internal and external storage.

**Unicode.** A universal character encoding standard that supports the interchange, processing, and display of text that is written in any of the languages of the modern world. It also supports many classical and historical texts in a number of languages. The Unicode standard has a 16-bit international character set defined by ISO 10646. See also *ASCII*.

**unit.** A means of referring to a file to use in input/output statements. A unit can be connected or not connected to a file. If connected, it refers to a file. The connection is symmetric: that is, if a unit is connected to a file, the file is connected to the unit.

**unsafe option.** Any option that could result in undesirable results if used in the incorrect context. Other options may result in very small variations from the default result, which is usually acceptable. Typically, using an unsafe option is an assertion that your code is not subject to the conditions that make the option unsafe.

**use association.** The association of names in different scoping units specified by a **USE** statement.

## V

**variable.** A data object whose value can be defined and redefined during the execution of an executable program. It may be a named data object, array element, array section, structure component, or substring. Note that in FORTRAN 77, a variable was always scalar and named.

## X

**XPG4.** X/Open Common Applications Environment (CAE) Portability Guide Issue 4; a document which defines the interfaces of the X/Open Common Applications Environment that is a superset of POSIX.1-1990, POSIX.2-1992, and POSIX.2a-1992 containing extensions to POSIX standards from XPG3.

## Z

**zero-length character.** A character object that has a length of 0 and is always defined.

**zero-sized array.** An array that has a lower bound that is greater than its corresponding upper bound. The array is always defined.

---

# Index

## Special characters

; statement separator 10, 12  
: (colon) editing 251  
:: (double colon) separator 287  
! inline comments 8, 9  
/ (slash) editing 250  
// (concatenation) operator 101  
' (apostrophe) editing 229  
(MODULE) PROCEDURE statement 418  
\$ (dollar) editing 251  
\* comment lines 9

## A

A (character) editing 233  
ABORT intrinsic subroutine 534  
ABS  
    initializing expressions 95  
    intrinsic function 535  
    specific name 535  
abstract interface 169, 273  
ACCESS specifier  
    of INQUIRE statement 374  
    of OPEN statement 400  
access, inquiring about 374  
accessibility  
    private 416  
    public 424  
ACHAR intrinsic function 536  
ACOS  
    intrinsic function 536  
    specific name 537  
ACOSD  
    intrinsic function 537  
    specific name 537  
ACTION specifier  
    of INQUIRE statement 374  
    of OPEN statement 400  
actual arguments  
    definition of 831  
    specification 180  
    specifying procedure names as 352  
addition arithmetic operator 98  
ADJUSTL intrinsic function 537  
ADJUSTR intrinsic function 538  
ADVANCE specifier  
    of READ statement 426  
    of WRITE statement 481  
AIMAG  
    initializing expressions 95  
    intrinsic function 538  
    specific name 539  
AINT  
    intrinsic function 539

AINT (*continued*)  
    specific name 540  
alarm\_service and utility  
    subprogram 786  
ALGAMA specific name 597  
ALIGNX PowerPC intrinsic function 540  
ALL array intrinsic function 540  
ALLOCATABLE attribute 274  
ALLOCATE statement 275  
ALLOCATED array intrinsic  
    function 277, 541  
allocation status 26  
ALOG specific name 602  
ALOG10 specific name 603  
alphabetic character, definition of 831  
alphanumeric, definition of 831  
alternate entry point 343  
alternate return  
    point 182  
    specifier 181, 193  
AMAX0 specific name 607  
AMAX1 specific name 607  
AMIN0 specific name 613  
AMIN1 specific name 613  
AMOD specific name 618  
AND logical operator 102  
AND specific name 583  
ANINT intrinsic function 542  
ANINT specific name 543  
ANY array intrinsic function 543  
apostrophe (') editing 229  
arguments  
    *See also* actual arguments, dummy  
    argument  
    definition of 831  
    keywords 181  
    specification 180  
arithmetic  
    expressions 98  
    operators 98  
    relational expressions 105  
    type  
        complex 39, 40  
        integer 35  
        real 37  
arithmetic IF statement 368  
arrays  
    adjustable 75  
    allocatable 77  
    array pointers 78  
    assumed-shape 75  
    assumed-size 78, 96  
    automatic 74  
    bounds 71  
    constructors 88  
    declarators 73  
    description 71  
    deferred-shape 76  
    elements 80  
    explicit-shape 73  
    extents 72

arrays (*continued*)  
    pointee 75  
    pointer 78  
    rank 72  
    sections 82  
    shape 72  
    size 72  
    specification of 73  
    zero-sized 71  
asa command 201  
ASCII  
    character set 5, 819  
    definition of 831  
ASIN  
    intrinsic function 544  
    specific name 544  
ASIND  
    intrinsic function 544  
    specific name 545  
ASSERT 492  
ASSIGN statement 278  
assigned GO TO statement 365  
assignment  
    defined 165  
    intrinsic 110  
    masked array 115  
    pointer 123  
    procedure pointer 126  
    statements  
        described 110  
        statement label (ASSIGN) 278  
ASSOCIATE  
    construct 129  
    statement 279  
ASSOCIATED intrinsic function 277, 545  
association  
    argument 183  
    common 305  
    description 150  
    entry 364  
    equivalence 349  
    host 150  
    integer pointer 154  
    pointer 152  
    use 151  
asterisk as dummy argument 182, 193  
asynch I/O  
    INQUIRE statement and 375  
    OPEN statement and 401  
    READ statement and 428  
    WRITE statement and 482  
ASYNCH specifier  
    of INQUIRE statement 374  
    of OPEN statement 400  
asynchronous I/O  
    data transfer and 207  
    INQUIRE statement and 375  
    OPEN statement and 401  
    READ statement and 428  
    WAIT statement and 477  
    WRITE statement and 483

ASYNCHRONOUS specifier 481  
  of INQUIRE statement 374  
  of OPEN statement 400  
  of READ statement 426  
  of WAIT statement 476

ASYNCHRONOUS statement 280

ATAN  
  intrinsic function 546  
  specific name 547

ATAN2  
  intrinsic function 547  
  specific name 548

ATAN2D  
  intrinsic function 548  
  specific name 549

ATAND  
  intrinsic function 547  
  specific name 547

attributes  
  ALLOCATABLE 274  
  AUTOMATIC 282  
  BIND 285  
  description 272  
  DIMENSION 322  
  EXTERNAL 352  
  INTENT 387  
  INTRINSIC 392  
  OPTIONAL 407  
  PARAMETER 409  
  POINTER 410  
  PRIVATE 416  
  PROTECTED 422  
  PUBLIC 424  
  SAVE 444  
  STATIC 451  
  TARGET 456  
  VALUE 472  
  VOLATILE 474

AUTOMATIC attribute 282

automatic object 18

## B

B (binary) editing 234

BACKSPACE statement 283

base type 51

bic\_ service and utility subprogram 787

binary

  constants 30  
  editing (B) 234  
  operations 93

BIND attribute 285

BIND statement 285

bis\_ service and utility subprogram 787

bit\_ service and utility subprogram 788

BIT\_SIZE

  intrinsic function 96, 549  
  intrinsic, constant expressions and 94

blank

  common block 304  
  editing 251  
  interpretation during formatting,  
  setting 251  
  null (BN) editing 251  
  specifier  
  of INQUIRE statement  
  (BLANK) 374

blank (*continued*)  
  specifier (*continued*)  
  of OPEN statement (BLANK) 400  
  zero (BZ) editing 251

block

  ELSE 136  
  ELSE IF 136  
  IF 136, 369  
  statement 129

block data

  program unit 174  
  statement (BLOCK DATA) 286

BLOCKLOOP 494

BN (blank null) editing 251

branching control 142

BTEST

  intrinsic function 550  
  specific name 551

byte named constants 110

BYTE type declaration statement 287

BZ (blank zero) editing 251

## C

C\_ASSOCIATED intrinsic procedure 747

C\_F\_POINTER intrinsic procedure 748

C\_FUNLOC intrinsic procedure 748

C\_LOC intrinsic procedure 748

CABS specific name 535

CACHE\_ZERO compiler directive 519

CALL statement 290

CASE

  construct 137, 292  
  statement 292

CCOS specific name 556

CDABS specific name 535

CDCOS specific name 556

CDEXP specific name 572

CDLOG specific name 602

CDSIN specific name 651

CDSQRT specific name 657

CEILING intrinsic function 551

CEXP specific name 572

CHAR

  intrinsic function 552  
  specific name 553

character

  editing

    (A) 233  
    (Q), count 247

  expressions 100

  format specification 361

  multibyte 43

  operator 101

  relational expressions 105

  set 5

  string edit descriptor 229

  substrings 43

CHARACTER type declaration  
statement 294

CHARACTER\_STORAGE\_SIZE 751

character-string editing 229

chtz command 562

chunk

  definition of 832

clock\_ service and utility  
subprogram 788

CLOG specific name 602

CLOSE statement 301

clr\_fpcsr\_flags subprogram 758

CMPLX

  initializing expressions 95

  intrinsic function 553

  specific name 553

CNCALL 496

CNVERR run-time option

  conversion errors and 220

  implied-DO list and 434, 488

COLLAPSE 497

collating sequence 5

colon (:) editing 251

COMMAND\_ARGUMENT\_COUNT

  intrinsic function 554

comment lines

  description 8

  fixed source form format 9

  free source form input format 11

  order within a program unit 15

common

  association 305

  block 6, 303

COMMON statement 303

communication between program units

  using arguments 180

  using common blocks 303

  using modules 171

compatibility across standards 815

compiler directives

*See* directives

compiler options

  -I 499

  -qalias 184

  -qautodbl 534

  -qci 499

  -qctyplss

    and the CASE statement 294

    character constants and 43, 109

    typeless constants and 31

  -qddim 75, 413

  -qdirective 511

  -qdlines 10

  -qescape

    and Hollerith constants 30

    apostrophe editing and 229

    double quotation mark editing

    and 229

    H editing and 243

  -qextname 785

  -qfixed 8

  -qintlog 108, 162

  -qintsize

    integer default size and 35, 40

    intrinsic procedure return types

    and 534

  -qlog4 108

  -qmbcs 229, 243

  -qmixed 6, 499

  -qnoescape 43

  -qnosave 27, 372

  -qnullterm 42

  -qposition 212, 400

  -qqcount 247

  -qrealsize 36, 534

  -qrecur 195

- compiler options (*continued*)
    - CALL statement and 291
    - ENTRY statement and 346
    - FUNCTION statement and 364
    - qsave 27, 372
    - qsigtrap 650
    - qundef 372
    - qxflag=oldtab 9
    - qxl77
      - binary editing and 234, 240, 248
      - hexadecimal editing and 249
      - octal editing and 246
      - OPEN statement and 406
      - real and complex editing and 241, 242
    - qxl90 226, 648
    - qzerosize 44
    - U 785
  - complex data type 39
  - complex editing 223
  - COMPLEX type declaration statement 307
  - component designator 53
  - component order 57
  - computed GO TO statement 366
  - concatenation operator 101
  - conditional
    - INCLUDE 499
    - vector merge intrinsic functions 560
  - conditional compilation 13
  - conformable arrays 90, 530
  - CONJG
    - initializing expressions 95
    - intrinsic function 554
    - specific name 555
  - conjunction, logical 102
  - constants
    - arithmetic
      - complex 39, 40
      - integer 35
      - real 37
    - binary 30
    - byte named 110
    - character 41
    - description 18
    - expressions 94
    - hexadecimal 28
    - Hollerith 30
    - logical 41
    - octal 29
    - typeless 28
  - construct
    - ASSOCIATE 129
    - CASE 137
    - DO 131
    - DO WHILE 135
    - FORALL 120
    - IF 136
    - WHERE 113
  - construct entities 146
  - construct entity 149
  - construct name 149
  - constructors
    - for arrays 88
    - for complex objects 39, 40
    - for structures 67
  - CONTAINS statement 312
  - continuation
    - character 9
    - lines 8
  - CONTINUE statement 313
  - control
    - edit descriptors 228
    - format 231
    - statements
      - arithmetic IF 368
      - assigned GO TO 365
      - block IF 369
      - computed GO TO 366
      - CONTINUE 313
      - DO 323
      - DO WHILE 325
      - END 335
      - logical IF 370
      - PAUSE 410
      - STOP 452
      - unconditional GO TO 367
    - transfer of 15
  - control mask 115
  - control structures 129
  - COS
    - intrinsic function 555
    - specific name 556
  - COSD
    - intrinsic function 556
    - specific name 556
  - COSH
    - intrinsic function 556
    - specific name 557
  - COUNT array intrinsic function 557
  - CPU\_TIME intrinsic function 558
  - cpu\_time\_type run-time option 558
  - CQABS specific name 535
  - CQCOS specific name 556
  - CQEXP specific name 572
  - CQLOG specific name 602
  - CQSIN specific name 651
  - CQSQRT specific name 657
  - CSHIFT array intrinsic function 559
  - CSIN specific name 651
  - CSQRT specific name 657
  - ctime\_ service and utility subprogram 788
  - CVMGM, CVMGN, CVMGP, CVMGT, CVMGZ intrinsic functions 560
  - CYCLE statement 313
- ## D
- D (double precision) editing 235
  - D debug lines 8
  - DABS specific name 535
  - DACOS specific name 537
  - DACOSD specific name 537
  - DASIN specific name 544
  - DASIND specific name 545
  - data
    - edit descriptors 223, 233
    - objects 17
    - statement (DATA) 314
    - type
      - derived 47
    - types
      - conversion rules 99
  - data (*continued*)
    - types (*continued*)
      - description 15
      - intrinsic 35
      - predefined conventions 17
  - data transfer
    - asynchronous 207
    - executing 206
    - statement
      - PRINT 414
      - READ 425
      - WRITE 481
  - DATAN specific name 547
  - DATAN2 specific name 548
  - DATAN2D specific name 549
  - DATAND specific name 547
  - date service and utility subprogram 789
  - DATE\_AND\_TIME intrinsic subroutine 562
  - DBLE
    - initializing expressions 95
    - intrinsic function 563
    - specific name 564
  - DBLEQ specific name 564
  - DC (decimal) editing 252
  - DCBFL compiler directive 519
  - DCMPLX
    - initializing expressions 95
    - intrinsic function 564
    - specific name 565
  - DCONJG specific name 555
  - DCOS specific name 556
  - DCOSD specific name 556
  - DCOSH specific name 557
  - DDIM specific name 566
  - DEALLOCATE statement 318
  - debug lines 8, 10
  - decimal (DC and DP) editing 252
  - DECIMAL specifier
    - of INQUIRE statement 374
    - of READ statement 426
    - of WRITE statement 481
  - declarators
    - array 73
    - scoping level 146
  - declaring procedures 176
  - default typing 17
  - deferred-shape arrays 76
  - defined assignment 165
  - defined operations 106
  - defined operators 163
  - definition status 19
  - DELIM specifier
    - of INQUIRE statement 374
    - of OPEN statement 400
  - DERF specific name 571
  - DERFC specific name 571
  - derived types
    - array structure components 86
    - description 47
    - determining the type of 66
    - scalar structure components 53
    - structure components 47
    - structure constructor 67
    - derived-type statement 320
  - designators
    - for array elements 80

- designators (*continued*)
    - for components 53
  - DEXP specific name 572
  - DFLOAT specific name 564
  - digits 5
  - DIGITS intrinsic function 565
  - DIM
    - initializing expressions 95
    - intrinsic function 566
    - specific name 566
  - DIMAG specific name 539
  - DIMENSION attribute 322
  - dimension bound expression 71
  - dimensions of an array 72
  - DINT specific name 540
  - DIRECT specifier, of INQUIRE statement 374
  - directive lines 8
  - directives
    - CACHE\_ZERO 519
    - DCBFL 519
    - discussion 489
    - ISYNC 520
    - LIGHT\_SYNC 520
    - MEM\_DELAY 506
    - NEW 506
    - PROTECTED STREAM 524
  - Directives
    - @PROCESS 509
    - #LINE 503
    - ASSERT 492
    - assertive 492
    - BLOCKLOOP 494
    - CNCALL 496
    - COLLAPSE 497
    - EJECT 498
    - INCLUDE 498
    - INDEPENDENT 500
    - loop optimization 492
    - LOOPID 505
    - NOVECTOR 507
    - optimization 492
    - PERMUTATION 508
    - SNAPSHOT 509
    - SOURCEFORM 511
    - STREAM\_UNROLL 512
    - SUBSCRIPTORDER 513
    - UNROLL 515
    - UNROLL\_AND\_FUSE 517
  - disconnection, closing files and 206
  - disjunction, logical 102
  - division arithmetic operator 98
  - DLGAMA specific name 597
  - DLOG specific name 602
  - DLOG10 specific name 603
  - DMAX1 specific name 607
  - DMIN1 specific name 613
  - DMOD specific name 618
  - DNINT specific name 543
  - DO
    - loop 131, 323, 324
    - statement 131, 323
  - DO WHILE
    - construct 135
    - loop 325
    - statement 325
  - dollar (\$) editing 251
  - DONE specifier, of WAIT statement 476
  - DOT\_PRODUCT array intrinsic function 566
  - DOUBLE COMPLEX type declaration statement 326
  - double precision (D) editing 235
  - DOUBLE PRECISION type declaration statement 329
  - double quotation mark (&sdq;) editing 229
  - DP (decimal) editing 252
  - DPROD
    - initializing expressions 95
    - intrinsic function 567
    - specific name 568
  - DREAL specific name 639
  - DSIGN specific name 649
  - DSIN specific name 651
  - DSIND specific name 652
  - DSINH specific name 652
  - DSQRT specific name 657
  - DT editing 237
  - DTAN specific name 662
  - DTAND specific name 663
  - DTANH specific name 664
  - dtime\_ service and utility subprogram 789
  - dummy argument
    - asterisk as 193
    - definition of 833
    - description 182
    - intent attribute and 185
    - procedure as 192
    - procedure pointer as 192
    - variable as 188
  - dummy procedure 192
  - dummy procedure pointer 192
  - dynamic extent, definition of 834
- ## E
- E (real with exponent) editing 235
  - EBCDIC character set 819
  - edit descriptors
    - character string 229
    - control (nonrepeatable) 228
    - data (repeatable) 223
    - names and 6
  - editing
    - : (colon) 251
    - / (slash) 250
    - ' (apostrophe) 229
    - " (double quotation mark) 229
    - \$ (dollar) 251
    - A (character) 233
    - B (binary) 234
    - BN (blank null) 251
    - BZ (blank zero) 251
    - character count Q 247
    - character-string 229
    - D (double precision) 235
    - DC and DP (decimal) 252
    - DT 237
    - E (real with exponent) 235
    - EN 237
    - ES 239
    - F (real without exponent) 240
  - editing (*continued*)
    - G (general) 241
    - H 243
    - I (integer) 244
    - L (logical) 245
    - O (octal) 245
    - P (scale factor) 253
    - Q (extended precision) 235
    - RC, RD, RN, RP, RU, and RZ (round) 254
    - S, SS, and SP (sign control) 254
    - T, TL, TR, and X (positional) 255
    - Z (hexadecimal) 248
  - efficient floating-point control and inquiry procedures
    - clr\_fpscr\_flags 758
    - discussion 756
    - fp\_trap 758
    - get\_fpscr 759
    - get\_fpscr\_flags 759
    - get\_round\_mode 760
    - set\_fpscr 760
    - set\_fpscr\_flags 760
    - set\_round\_mode 761
  - EIEIO compiler directive 520
  - EJECT 498
  - ELEMENTAL 198
  - elemental intrinsic procedures 529
  - elemental procedures 198
  - ELSE
    - block 136
    - statement 136, 332
  - ELSE IF
    - block 136
    - statement 136, 333
  - ELSEWHERE statement 113, 333
  - EN editing 237
  - END ASSOCIATE statement 336
  - END DO statement 131, 336
  - END ENUM statement 347
  - END FORALL statement 336
  - END IF statement 136, 336
  - END INTERFACE statement 158, 339
  - END SELECT statement 336
  - END specifier
    - of READ statement 426
    - of WAIT statement 476
  - END statement 335
  - END TYPE statement 341
  - END WHERE statement 113, 336
  - end-of-file conditions 215
  - end-of-record conditions 214
  - end-of-record, preventing with \$ editing 251
  - ENDFILE statement 341
  - entities, scope of 146
  - entry
    - association 364
    - name 344
    - statement (ENTRY) 343
  - ENUM statement 347
  - enumerators 347
  - EOR specifier, of READ statement 426
  - EOSHIFT array intrinsic function 568
  - EPSILON intrinsic function 569
  - equivalence
    - logical 102



- EQUIVALENCE
    - association 349
    - restriction on COMMON and 306
  - EQUIVALENCE statement 348
  - EQV logical operator 102
  - ERF
    - intrinsic function 570
    - specific name 571
  - ERFC
    - intrinsic function 571
    - specific name 571
  - ERR specifier
    - of BACKSPACE statement 283
    - of CLOSE statement 302
    - of ENDFILE statement 342
    - of INQUIRE statement 374
    - of OPEN statement 400
    - of READ statement 426
    - of REWIND statement 443
    - of WAIT statement 476
    - of WRITE statement 481
  - ERR\_RECOVERY run-time option
    - BACKSPACE statement and 284
    - conversion errors and 220
    - EDNFILE statement and 343
    - Fortran 90 language errors and 221
    - Fortran 95 language errors and 221
    - OPEN statement and 406
    - READ statement and 434
    - REWIND statement and 443
    - severe errors and 215
    - WRITE statement and 488
  - error conditions 215
  - ERROR\_UNIT 751
  - errors
    - catastrophic 215
    - conversion 220
    - Fortran 90 language 221
    - Fortran 95 language 221
    - recoverable 217
    - severe 215
  - ES editing 239
  - escape sequences 42
  - etime\_ service and utility
    - subprogram 790
  - exclusive disjunction, logical 102
  - executable program 154
  - executing data transfer statements 206
  - execution sequence 15
  - execution\_part 170
  - EXIST specifier, of INQUIRE
    - statement 374
  - EXIT statement 351
  - exit\_ service and utility subprogram 790
  - EXP
    - intrinsic function 572
    - specific name 572
  - explicit
    - interface 157
    - typing 17
  - explicit-shape arrays 73
  - EXPONENT intrinsic function 572
  - exponentiation arithmetic operator 98
  - expressions
    - arithmetic 98
    - character 100
    - constant 94
    - expressions (*continued*)
      - dimension bound 71
      - general 101
      - in FORMAT statement 361
      - initialization 95
      - logical 102
      - primary 104
      - relational 105
      - restricted 96
      - specification 96
    - extended
      - intrinsic operations 106
      - precision (Q) editing 235
    - extended type 51
    - EXTENDS\_TYPE\_OF intrinsic
      - function 573
    - external
      - function 362
      - subprograms in the XL Fortran
        - library 785
    - EXTERNAL attribute 352
    - external files 203
- F**
- F (real without exponent) editing 240
  - factor
    - arithmetic 98
    - logical 102
  - FCFI PowerPC intrinsic function 671
  - FCTID PowerPC intrinsic function 671
  - FCTIDZ PowerPC intrinsic function 672
  - FCTIW PowerPC intrinsic function 672
  - FCTIWZ PowerPC intrinsic function 673
  - fdate\_ service and utility
    - subprogram 790
  - fexcp.h include file 650
  - file position
    - BACKSPACE statement, after
      - execution 284
    - before and after data transfer 212
    - ENDFILE statement, after
      - execution 343
    - REWIND statement, after
      - execution 443
  - file positioning statement
    - BACKSPACE statement 283
    - ENDFILE statement 341
    - REWIND statement 442
  - FILE specifier
    - of INQUIRE statement 374
    - of OPEN statement 400
  - FILE\_STORAGE\_SIZE 751
  - files 202
  - finalizable 62
  - fiosetup\_ service and utility
    - subprogram 791
  - fixed source form 8
  - FLOAT specific name 639
  - FLOOR intrinsic function 574
  - flush\_ service and utility
    - subprogram 792
  - FMADD PowerPC intrinsic function 673
  - FMSUB PowerPC intrinsic function 674
  - FMT specifier
    - of PRINT statement 414
    - of READ statement 426
  - FMT specifier (*continued*)
    - of WRITE statement 481
  - FNABS PowerPC intrinsic function 674
  - FNMADD PowerPC intrinsic
    - function 675
  - FNMSUB PowerPC intrinsic
    - function 675
  - FORALL
    - construct 120
    - statement 355
  - FORALL (Construct) statement 358
  - FORM specifier
    - of INQUIRE statement 374
    - of OPEN statement 400
  - format
    - conditional compilation 13
    - control 231
    - fixed source form 8
    - free source form 11
    - IBM free source form 12
    - interaction with input/output
      - list 231
    - specification
      - character 361
      - statement (FORMAT) 360
  - format-directed formatting 223
  - formatted
    - specifier of INQUIRE statement
      - (FORMATTED) 374
  - fp\_trap subprogram 758
  - fpgets and fpsets service and utility
    - subprograms 755
  - fpscr constants
    - Exception Details Flags 757
    - Exception Summary Flags 757
    - fp\_trap constants 758
    - general 757
    - IEEE Exception Enable Flags 757
    - IEEE Exception Status Flags 757
    - IEEE Rounding Modes 757
    - list 757
  - fpscr procedures
    - clr\_fpscr\_flags 758
    - discussion 756
    - fp\_trap 758
    - get\_fpscr 759
    - get\_fpscr\_flags 759
    - get\_round\_mode 760
    - set\_fpscr 760
    - set\_fpscr\_flags 760
    - set\_round\_mode 761
  - FRACTION intrinsic function 575
  - FRE PowerPC intrinsic function 676
  - free source form 11
  - free source form format
    - IBM 12
  - FRES PowerPC intrinsic function 676
  - FRIM PowerPC intrinsic function 677
  - FRIN PowerPC intrinsic function 677
  - FRIP PowerPC intrinsic function 678
  - FRIZ PowerPC intrinsic function 678
  - FRSQRT PowerPC intrinsic
    - function 678
  - FRSQRTES PowerPC intrinsic
    - function 679
  - FSEL PowerPC intrinsic function 679

ftell\_ service and utility  
 subprograms 792  
 ftell64\_ service and utility  
 subprogram 793  
 function  
 intrinsic 785  
 reference 177  
 specification 97  
 statement 449  
 subprogram 176  
 value 177  
 FUNCTION statement 362

## G

G (general) editing 241  
 GAMMA  
 intrinsic function 575  
 specific name 576  
 general expression 101  
 general service and utility  
 procedures 785  
 get\_fpscr subprogram 759  
 get\_fpscr\_flags subprogram 759  
 GET\_COMMAND intrinsic  
 subroutine 577  
 GET\_COMMAND\_ARGUMENT intrinsic  
 subroutine 578  
 GET\_ENVIRONMENT\_VARIABLE  
 intrinsic subroutine 579  
 get\_round\_mode subprogram 760  
 getarg service and utility  
 subprogram 793  
 getcwd\_ service and utility  
 subprogram 794  
 GETENV intrinsic subroutine 576  
 getfd service and utility  
 subprogram 794  
 getgid\_ service and utility  
 subprogram 794  
 getlog\_ service and utility  
 subprogram 795  
 getpid\_ service and utility  
 subprogram 795  
 getuid\_ service and utility  
 subprogram 795  
 global entities 146  
 global\_timef service and utility  
 subprogram 796  
 gmtime\_ service and utility  
 subprogram 796  
 GO TO statement  
 assigned 365  
 computed 366  
 unconditional 367

## H

H editing 243  
 hexadecimal  
 (Z) editing 248  
 constants 28  
 HFIX elemental function 580  
 HFIX specific name 581  
 Hollerith constants 6, 30

host  
 association 145, 150  
 scoping unit 145  
 hostnm\_ service and utility  
 subprogram 796  
 HUGE intrinsic function 581

## I

I (integer) editing 244  
 IABS specific name 535  
 IACHAR intrinsic function 582  
 IAND  
 intrinsic function 582  
 specific name 583  
 iargc service and utility subprogram 797  
 IBCLR  
 intrinsic function 583  
 specific name 584  
 IBITS  
 intrinsic function 584  
 specific name 584  
 IBM free source form 12  
 IBSET  
 intrinsic function 584  
 specific name 585  
 ICHAR  
 intrinsic function 585  
 specific name 586  
 ID specifier  
 of INQUIRE statement 374  
 of READ statement 426  
 of WAIT statement 476  
 of WRITE statement 481  
 idate\_ service and utility  
 subprogram 797  
 identity arithmetic operator 98  
 IDIM specific name 566  
 IDINT specific name 589  
 IDNINT specific name 622  
 IEEE Modules and Support 761  
 IEEE Operators 765  
 IEEE Procedures 765  
 IEEE\_CLASS 766  
 IEEE\_CLASS\_TYPE 764  
 IEEE\_COPY\_SIGN 766  
 IEEE\_FEATURES\_TYPE 764  
 IEEE\_FLAG\_TYPE 763  
 IEEE\_GET\_FLAG 767  
 IEEE\_GET\_HALTING 767  
 IEEE\_GET\_ROUNDING 768  
 IEEE\_GET\_STATUS 768  
 IEEE\_IS\_FINITE 768  
 IEEE\_IS\_NAN 769  
 IEEE\_IS\_NEGATIVE 769  
 IEEE\_IS\_NORMAL 770  
 IEEE\_LOGB 770  
 IEEE\_NEXT\_AFTER 771  
 IEEE\_REM 771  
 IEEE\_RINT 772  
 IEEE\_ROUND\_TYPE 764  
 IEEE\_SCALB 772  
 IEEE\_SELECTED\_REAL\_KIND 773  
 IEEE\_SET\_FLAG 773  
 IEEE\_SET\_HALTING 774  
 IEEE\_SET\_ROUNDING 774  
 IEEE\_SET\_STATUS 775

IEEE\_STATUS\_TYPE 764  
 IEEE\_SUPPORT\_DATATYPE 775  
 IEEE\_SUPPORT\_DENORMAL 776  
 IEEE\_SUPPORT\_DIVIDE 776  
 IEEE\_SUPPORT\_FLAG 776  
 IEEE\_SUPPORT\_HALTING 777  
 IEEE\_SUPPORT\_INF 777  
 IEEE\_SUPPORT\_IO 777  
 IEEE\_SUPPORT\_NAN 778  
 IEEE\_SUPPORT\_ROUNDING 778  
 IEEE\_SUPPORT\_SQRT 779  
 IEEE\_SUPPORT\_STANDARD 779  
 IEEE\_UNORDERED 780  
 IEEE\_VALUE 780  
 IEOR  
 intrinsic function 586  
 specific name 587  
 ierrno\_ service and utility  
 subprogram 798  
 IF  
 construct 136  
 statement  
 arithmetic 368  
 block 369  
 logical 370  
 IFIX specific name 589  
 ILEN intrinsic function 587  
 IMAG  
 initializing expressions 95  
 intrinsic function 587  
 implicit  
 connection 205  
 interface 158  
 typing 17  
 IMPLICIT  
 description 371  
 statement, storage class assignment  
 and 27  
 type determination and 17  
 implied-DO  
 array constructor list in 90  
 DATA statement and 316  
 IMPORT  
 description 373  
 INCLUDE 498  
 inclusive disjunction, logical 102  
 incrementation processing 133  
 INDEPENDENT 500  
 INDEX  
 initializing expressions 95  
 intrinsic function 588  
 specific name 588  
 inherited length  
 by a named constant 299, 466  
 initial  
 line 8  
 value, declaring 315  
 initialization expressions 95  
 inline comments 8  
 INPUT\_UNIT 752  
 input/output conditions 214  
 INQUIRE statement 374  
 inquiry intrinsic functions 529  
 BIT\_SIZE 549  
 DIGITS 565  
 EPSILON 569  
 HUGE 581

inquiry intrinsic functions (*continued*)  
 KIND 594  
 LEN 596  
 LOC 601  
 MAXEXPONENT 608  
 MINEXPONENT 613  
 PRECISION 629  
 PRESENT 630  
 RADIX 634  
 RANGE 637  
 TINY 664

INT  
 initializing expressions 95  
 intrinsic function 588  
 specific name 589

INT2 intrinsic function 589

integer  
 data type 35  
 editing (I) 244  
 pointer association 154  
 POINTER statement 412

INTEGER type declaration  
 statement 383

INTENT attribute 387

interface  
 blocks 158  
 implicit 158  
 statement (INTERFACE) 389

interference 493, 500

interlanguage calls  
 %VAL and %REF functions 184

internal  
 function 362  
 procedures 155

internal files 203

intrinsic  
 assignment 110  
 attribute (INTRINSIC) 392  
 data types 35  
 functions  
   *See also* intrinsic procedures  
   conditional vector merge 560  
   detailed descriptions 534  
   generic 179  
   specific 179

inquiry  
   *See* inquiry intrinsic functions  
 procedures 179  
 description 534  
 discussion 529  
 elemental 529  
 inquiry 529, 530  
 name in an INTRINSIC  
   statement 392  
   subroutines 531  
   transformational 531  
 statement (INTRINSIC) 163  
 subroutines 531

invocation commands 8

IOMSG specifier  
 of BACKSPACE statement 283  
 of CLOSE statement 302  
 of ENDFILE statement 342  
 of INQUIRE statement 374  
 of OPEN statement 400  
 of READ statement 426  
 of REWIND statement 443

IOMSG specifier (*continued*)  
 of WAIT statement 476  
 of WRITE statement 481

IOR  
 intrinsic function 590  
 specific name 591

IOSTAT specifier  
 of BACKSPACE statement 283  
 of CLOSE statement 302  
 of ENDFILE statement 342  
 of INQUIRE statement 374  
 of OPEN statement 400  
 of READ statement 426  
 of REWIND statement 443  
 of WAIT statement 476  
 of WRITE statement 481

IOSTAT values 214

IOSTAT\_END 752

IOSTAT\_EOR 752

IQINT specific name 589

IQNINT specific name 622

irand service and utility  
 subprogram 798

irtc service and utility subprogram 798

IS\_IOSTAT\_END  
 intrinsic function 591

IS\_IOSTAT\_EOR  
 intrinsic function 592

ISHFT  
 intrinsic function 592  
 specific name 593

ISHFTC  
 intrinsic function 593  
 specific name 593

ISIGN specific name 649

ISO\_FORTRAN\_ENV intrinsic  
 module 751

ISYNC compiler directive 520

iteration count  
 DO statement and 132  
 in implied-DO list of a DATA  
 statement 317

itime\_ service and utility  
 subprogram 799

**J**  
 jdate service and utility subprogram 799

**K**  
 keywords  
 argument 181  
 statement 7

KIND  
 intrinsic function 594  
 intrinsic, constant expressions and 94  
 intrinsic, restricted expressions 96  
 kind type parameter 16

**L**  
 L (logical) editing 245  
 labels, statement 7  
 langlvl run-time option 263  
 LANGLVL run-time option 221

LBOUND array intrinsic function 594

LEADZ intrinsic function 595

LEN  
 intrinsic function 596  
 intrinsic, constant expressions and 94  
 intrinsic, restricted expressions 96  
 specific name 596

LEN\_TRIM intrinsic function 596

lenchr\_ service and utility  
 subprogram 799

length type parameter 16

length, inherited by a named  
 constant 299, 466

letters, character 5

lexical  
 tokens 5

lexical extent, definition of 836

LGAMMA  
 intrinsic function 597  
 specific name 597

LGE  
 intrinsic function 598  
 specific name 598

LGT  
 intrinsic function 599  
 specific name 599

library subprograms 785

LIGHT\_SYNC compiler directive 520

line breaks, preventing with \$  
 editing 251

lines  
 comment 8  
 conditional compilation 13  
 continuation 8  
 debug 8, 10  
 directive 8, 489  
 initial 8  
 source formats and 7

linker options  
 -bname 785

list-directed formatting 256  
 value separators 256

list-directed input 257  
 end-of-record 258  
 rules 257

list-directed output 258  
 rules 259  
 types 258  
 written field width 259

literal storage class 26

LLE  
 intrinsic function 599  
 specific name 600

LLT  
 intrinsic function 600  
 specific name 601

lnblnk\_ service and utility  
 subprogram 800

LOC  
 intrinsic function 127, 601

local entities 146

LOG intrinsic function 601

LOG10 intrinsic function 603

logical  
 (L) editing 245  
 conjunction 102  
 data type 40

logical (*continued*)  
 equivalence 102  
 exclusive disjunction 102  
 expressions 102  
 IF statement 370  
 inclusive disjunction 102  
 intrinsic function (LOGICAL) 603  
 negation 102  
 nonequivalence 102  
 type declaration statement  
 (LOGICAL) 393

loop  
 carried dependency 493, 500  
 control processing 133  
 DO construct and 131

LOOPID 505

LSHIFT  
 elemental function 604  
 specific name 604

ltime\_ service and utility  
 subprogram 800

## M

main program 170, 422  
 many-one section 85  
 masked array assignment 115  
 masked ELSEWHERE statement 113,  
 333  
 MATMUL array intrinsic function 604  
 MAX  
 initializing expressions 95  
 intrinsic function 607  
 MAX0 specific name 607  
 MAX1 specific name 607  
 MAXEXPONENT intrinsic function 608  
 MAXLOC array intrinsic function 608  
 MAXVAL array intrinsic function 610  
 mclock service and utility  
 subprogram 801  
 MEM\_DELAY compiler directive 506  
 MERGE array intrinsic function 611  
 MIN  
 initializing expressions 95  
 intrinsic function 612  
 MIN0 specific name 613  
 MIN1 specific name 613  
 MINEXPONENT intrinsic function 613  
 MINLOC array intrinsic function 614  
 MINVAL array intrinsic function 616  
 MOD  
 initializing expressions 95  
 intrinsic function 617  
 specific name 618

module  
 description 171  
 reference 151, 468  
 statement (MODULE) 397

MODULO intrinsic function 618  
 MOVE\_ALLOC intrinsic function 619  
 MTSF PowerPC intrinsic function 680  
 MTSFI PowerPC intrinsic function 680  
 MULHY PowerPC intrinsic function 681  
 multibyte characters 43  
 multiplication arithmetic operator 98  
 MVBITS intrinsic subroutine 619

## N

name  
 common block 303  
 description 6  
 determining storage class of 26  
 determining type of 17  
 entry 344  
 of a generic or specific function 179  
 scope of a 146

NAME specifier, of INQUIRE  
 statement 374

name-value subsequences 261  
 named common block 304  
 NAMED specifier, of INQUIRE  
 statement 374

namelist  
 group 6

NAMELIST  
 run-time option 266  
 statement 398

namelist comments 261  
 namelist formatting 260  
 namelist input 260  
 rules 262

namelist output 265

NEAREST intrinsic function 620

negation  
 arithmetic operator 98  
 logical operator 102

NEQV logical operator 102

NEW compiler directive 506

NEWLINE  
 intrinsic function 621

NEXTREC specifier  
 of INQUIRE statement 374

NINT  
 initializing expressions 95  
 intrinsic function 622  
 specific name 622

NML specifier  
 of READ statement 426  
 of WRITE statement 481

nonequivalence, logical 102

NOT  
 intrinsic function 622  
 logical operator 102  
 specific name 623

NOVECTOR 507

NULL  
 initializing expressions 95  
 intrinsic function 623

NULLIFY statement 399

NUM specifier  
 of READ statement 426  
 of WRITE statement 481

NUM\_PARTHDS inquiry intrinsic  
 function 624

NUM\_USRTHDS inquiry intrinsic  
 function 626

NUMBER specifier, of INQUIRE  
 statement 374

NUMBER\_OF\_PROCESSORS intrinsic  
 function 625

NUMERIC\_STORAGE\_SIZE 753

## O

O (octal) editing 245  
 objects, data 17  
 octal (O) editing 245  
 octal constants 29  
 of WRITE statement 481

ONLY clause of USE statement 469

OPEN statement 400

OPENED specifier, of INQUIRE  
 statement 374

operations  
 defined 106  
 extended intrinsic 106

operators  
 arithmetic 98  
 character 101  
 defined 163  
 logical 102  
 precedence of 107  
 relational 105

optional arguments 186

OPTIONAL attribute 407

OR  
 logical operator 102  
 specific name 591

order  
 of elements in an array 81  
 of statements 14

OUTPUT\_UNIT 753

## P

P (scale factor) editing 253

PACK array intrinsic function 626

PAD specifier  
 of INQUIRE statement 374  
 of OPEN statement 400

PARAMETER attribute 409

parent type 51

PAUSE statement 410

pending control mask 115

PENDING specifier  
 of INQUIRE statement 374

Performance  
 drawbacks  
 sequence derived types 51

PERMUTATION 508

Pixel data type 46

pointee  
 arrays 75  
 POINTER statement and 413

pointer  
 assignment 123  
 association 152  
 attribute, POINTER (Fortran 90) 410

POPCNT intrinsic function 627

POPCNTB intrinsic function 681

POPPAR intrinsic function 628

POSITION specifier  
 of INQUIRE statement 374  
 of OPEN statement 400

positional (T, TL, TR, and X) editing 255

precedence  
 of all operators 107  
 of arithmetic operators 98  
 of logical operators 102

PRECISION intrinsic function 629  
 precision of real objects 37  
 preconnection 205  
 PREFETCH compiler directives 521  
 PRESENT intrinsic function 407, 630  
 primaries (expressions) 93  
 primary expressions 104  
 PRINT statement 414  
 PRIVATE  
   attribute 416  
   statement 416  
 procedure  
   dummy 192  
   external 154, 422  
   internal 155  
 procedure pointer 56  
 procedure pointer, assignment 126  
 procedure pointers 176  
 procedure references 177  
 PROCEDURE statement 419  
 procedure, invoked by a  
   subprogram 154  
 PROCESSORS\_SHAPE intrinsic  
   function 630  
 PRODUCT array intrinsic function 631  
 PROGRAM statement 422  
 program unit 154  
 PROTECTED attribute 422  
 PROTECTED STREAM directives 524  
 PUBLIC attribute 424  
 PURE 196  
 pure procedures 196

## Q

Q (extended precision) editing 235  
 QABS specific name 535  
 QACOS specific name 537  
 QACOSD specific name 537  
 QARCOS specific name 537  
 QARSIN specific name 544  
 QASIN specific name 544  
 QASIND specific name 545  
 QATAN specific name 547  
 QATAN2 specific name 548  
 QATAN2D specific name 549  
 QATAND specific name 547  
 QCMLPX  
   initializing expressions 95  
   intrinsic function 633  
   specific name 633  
 QCONJG specific name 555  
 QCOS specific name 556  
 QCOSD specific name 556  
 QCOSH specific name 557  
 QDIM specific name 566  
 QERF specific name 571  
 QERFC specific name 571  
 QEXP specific name 572  
 QEXT  
   initializing expressions 95  
   intrinsic function 634  
   specific name 634  
 QEXTD specific name 634  
 QFLOAT specific name 634  
 QGAMMA specific name 576  
 QIMAG specific name 539

QINT specific name 540  
 QLGAMA specific name 597  
 QLOG specific name 602  
 QLOG10 specific name 603  
 QMAX1 specific name 607  
 QMIN1 specific name 613  
 QMOD specific name 618  
 QNINT specific name 543  
 QPROD specific name 568  
 QREAL specific name 639  
 QSIGN specific name 649  
 QSIN specific name 651  
 QSIND specific name 652  
 QSINH specific name 652  
 qsort\_ service and utility  
   subprogram 801  
 qsort\_down service and utility  
   subprogram 802  
 qsort\_up service and utility  
   subprogram 802  
 QSQRT specific name 657  
 QTAN specific name 662  
 QTAND specific name 663  
 QTANH specific name 664

## R

RADIX intrinsic function 634  
 RAND intrinsic function 635  
 RANDOM\_NUMBER intrinsic  
   subroutine 635  
 RANDOM\_SEED intrinsic  
   subroutine 636  
 RANGE intrinsic function 637  
 rank  
   of array sections 88  
   of arrays 72  
 RC (round) editing 254  
 RD (round) editing 254  
 READ  
   specifier, of INQUIRE statement 374  
   statement 425  
 READWRITE specifier, of INQUIRE  
   statement 374  
 REAL  
   initializing expressions 95  
   intrinsic function 638  
   specific name 639  
 real data type 36  
 real editing  
   E (with exponent) 235  
   F (without exponent) 240  
   G (general) 241  
 REAL type declaration statement 435  
 REC specifier  
   of READ statement 426  
   of WRITE statement 481  
 RECL specifier  
   of INQUIRE statement 374  
   of OPEN statement 400  
 record  
   statements  
     statement label (RECORD) 439  
 RECORD statement 439  
 records  
   description 201  
 recursion  
   ENTRY statement and 346  
   FUNCTION statement and 364  
   procedures and 195  
   SUBROUTINE statement and 454  
 RECURSIVE keyword 364, 454  
 reference, function 177  
 relational  
   expressions 105  
   operators 105  
 REPEAT  
   intrinsic function 96, 639  
   intrinsic initialization expressions 95  
 repeat specification 360  
 RESHAPE  
   array intrinsic function 96, 640  
   array intrinsic initialization  
     expressions 95  
 restricted expression 96  
 RESULT keyword 345, 363  
 result variable 344, 363  
 return points and specifiers,  
   alternate 181  
 return specifier 15  
 RETURN statement 441  
 REWIND statement 442  
 right margin 9  
 RN (round) editing 254  
 ROTAELI PowerPC intrinsic  
   function 682  
 ROTAELM PowerPC intrinsic  
   function 682  
 round (RC, RD, RN, RP, RU, and RZ)  
   editing 254  
 ROUND specifier  
   of INQUIRE statement 374  
   of OPEN statement 400  
   of WRITE statement 481  
 rounding mode 100  
 RP (round) editing 254  
 RRSPPACING intrinsic function 641  
 RSHIFT  
   elemental function 642  
   specific name 642  
 rtc service and utility subprogram 803  
 RU (round) editing 254  
 run-time options  
   changing with SETRTEOPTS  
     procedure 803  
 CNVERR  
   conversion errors and 220  
   READ statement and 434  
   WRITE statement and 488  
 ERR\_RECOVERY 221  
   BACKSPACE statement and 284  
   conversion errors and 220  
   ENDFILE statement and 343  
   OPEN statement and 406  
   READ statement and 434  
   REWIND statement and 443  
   severe errors and 215  
   WRITE statement and 488  
 langlvl 263  
 LANGLVL 221  
 NAMELIST 266  
 NLWIDTH 266  
 UNIT\_VARS 205, 400

RZ (round) editing 254

## S

S (sign control) editing 254

SAME\_TYPE\_AS intrinsic function 642

SAVE attribute 444

scale factor (P) editing 253

SCALE intrinsic function 643

SCAN

initializing expressions 95

intrinsic function 644

scope, entities and 146

scoping unit 145

section\_subscript, syntax of for array

section 82

SELECT CASE statement

CASE construct 137

CASE statement and 292

description 446

SELECT TYPE statement

description 447

SELECTED\_CHAR\_KIND

intrinsic function 645

SELECTED\_INT\_KIND

intrinsic function 96, 645

intrinsic initialization expressions 95

SELECTED\_REAL\_KIND

intrinsic function 96, 646

intrinsic initialization expressions 95

selector 6

semicolon statement separator 10, 12

sequence derived type 47

SEQUENCE statement 448

sequential access 203

SEQUENTIAL specifier, of INQUIRE

statement 374

service and utility subprograms

alarm\_ 786

bic\_ 787

bis\_ 787

bit\_ 788

clock\_ 788

ctime\_ 788

date 789

discussion 785

dtime\_ 789

efficient floating-point control and

inquiry procedures 756

etime\_ 790

exit\_ 790

fdate\_ 790

fiosetup\_ 791

flush\_ 792

fpgets and fpsets 755

ftell\_ 792

ftell64\_ 793

general 785

getarg 793

getcwd\_ 794

getfd 794

getgid\_ 794

getlog\_ 795

getpid\_ 795

getuid\_ 795

global\_timef 796

gmtime\_ 796

service and utility subprograms

(continued)

hostnm\_ 796

iargc 797

idate\_ 797

ierrno\_ 798

irand 798

irtc 798

itime\_ 799

jdate 799

lenchr\_ 799

lnblnk\_ 800

ltime\_ 800

mclock 801

qsort\_ 801

qsort\_down 802

qsort\_up 802

rtc 803

setrteopts 803

sleep\_ 804

time\_ 804

timef 804

timef\_delta 805

umask\_ 805

usleep\_ 805

xl\_trbk 806

SET\_EXPONENT intrinsic function 647

set\_fpscr subprogram 760

set\_fpscr\_flags subprogram 760

set\_round\_mode subprogram 761

SETFSB0 PowerPC intrinsic function 683

SETFSB1 PowerPC intrinsic function 683

setrteopts service and utility

subprogram 803

SFTI PowerPC intrinsic function 684

shape

array intrinsic function (SHAPE) 648

of an array 72

of array sections 88

SIGN

initializing expressions 95

intrinsic function 648

specific name 649

sign control (S, SS, and SP) editing 254

SIGN specifier

of INQUIRE statement 374

of WRITE statement 481

SIGNAL intrinsic subroutine 650

signal.h include file 650

SIN

intrinsic function 650

specific name 651

SIND

intrinsic function 651

specific name 652

SINH

intrinsic function 652

specific name 652

SIZE

array intrinsic function 652

specifier, of READ statement 426

SIZEOF

intrinsic function 653

slash (/) editing 250

sleep\_ service and utility

subprogram 804

SNAPSHOT 509

SNGL specific name 639

SNGLQ specific name 639

sorting (qsort\_ procedure) 801

source file options 503, 509

source formats

conditional compilation 13

fixed source form 8

free source form 11

IBM free source form 12

SOURCEFORM 511

SP (sign control) editing 254

SPACING intrinsic function 654

special characters 5

specification array 73

specification expression 96

specification function 97

specification\_part 170

specifying kind 16

SPREAD array intrinsic function 655

SQRT

intrinsic function 656

specific name 657

SRAND intrinsic subroutine 657

SS (sign control) editing 254

statement

asynchronous 280

statements

assignment 110

BIND 285

block 129

description 7

discussion 269

entities 146, 148, 149

function statement 449

label assignment (ASSIGN)

statement 278

label record (RECORD)

statement 439

labels 7

order 14

terminal 131

STATIC

attribute 451

STATUS specifier

of CLOSE statement 302

of OPEN statement 400

STOP statement 452

storage

classes for variables

description 26

fundamental 26

literal 26

secondary 27

sequence within common blocks 306

sharing

using common blocks 304

using EQUIVALENCE 349

using integer pointers 154

using pointers 152

STREAM\_UNROLL 512

structure

array components 86

components 47

constructor 67

description 47

scalar components 53

subobjects of variables 17

- subprograms
  - external 154
  - function 362
    - external 176
    - internal 176
  - internal 155
  - invocation 154
  - references 177
  - service and utility 785
  - subroutine 176
- subroutine
  - functions and 175
  - intrinsic 785
  - statement (SUBROUTINE) 453
- subscript\_triplet, syntax of 83
- SUBSCRIPTORDER 513
- substring
  - character 43
  - ranges
    - relationship to array sections 85
    - specifying 83
- subtraction arithmetic operator 98
- SUM array intrinsic function 658
- SWDIV PowerPC intrinsic function 684
- SWDIV\_NOCHK PowerPC intrinsic function 685
- system inquiry intrinsic functions 530
- SYSTEM intrinsic subroutine 659
- SYSTEM\_CLOCK intrinsic subroutine 660

## T

- T (positional) editing 255
- tabs, formatting 9
- TAN
  - intrinsic function 662
  - specific name 662
- TAND
  - intrinsic function 663
  - specific name 663
- TANH
  - intrinsic function 663
  - specific name 664
- TARGET attribute 456
- terminal statement 131
- thread-safing
  - of Fortran 90 pointers 411
- time zone, setting 562
- time\_ service and utility
  - subprogram 804
- timef service and utility
  - subprogram 804
- timef\_delta service and utility
  - subprogram 805
- TINY intrinsic function 664
- TL (positional) editing 255
- TR (positional) editing 255
- TRANSFER intrinsic function
  - description 664
  - initialization expressions 95
  - restricted expressions 96
- transfer of control
  - description 15
  - in a DO loop 133
- TRANSFER specifier, of INQUIRE statement 374

- transformational intrinsic functions 531
- TRANSPOSE array intrinsic function 666
- TRAP PowerPC intrinsic function 686
- TRIM intrinsic function
  - description 666
  - initialization expressions 95
  - restricted expressions 96
- type declaration 461
  - BYTE 287
  - CHARACTER 294
  - COMPLEX 307
  - DOUBLE COMPLEX 326
  - DOUBLE PRECISION 329
  - INTEGER 383
  - LOGICAL 393
  - REAL 435
  - TYPE 457
  - VECTOR 473
- type specifier 16
- type, determining 17
- typeless constants
  - binary 30
  - hexadecimal 28
  - Hollerith 30
  - octal 29
  - using 31
- TZ environment variable 562

## U

- UBOUND array intrinsic function 667
- umask\_ service and utility
  - subprogram 805
- unambiguous references 161
- unary operations 93
- unconditional GO TO statement 367
- UNFORMATTED specifier
  - of INQUIRE statement 374
- Unicode characters and filenames
  - and character constants 229
  - character constants and 43
  - compiler option for 43
  - environment variable for 43
  - H editing and 243
  - Hollerith constants and 31
- UNIT specifier
  - of BACKSPACE statement 283
  - of CLOSE statement 302
  - of ENDFILE statement 342
  - of INQUIRE statement 374
  - of OPEN statement 400
  - of READ statement 426
  - of REWIND statement 443
  - of WRITE statement 481
- units, external files reference 205
- UNPACK array intrinsic function 668
- UNROLL 515
- UNROLL\_AND\_FUSE 517
- unsigned data type 46
- use association 151, 468
- USE statement 468
- usleep\_ service and utility
  - subprogram 805

## V

- VALUE attribute 472
- variable
  - description 17
  - format expressions and 361
- vector data type 45
- vector subscripts 85
- VECTOR type declaration statement 473
- VERIFY
  - initializing expressions 95
  - intrinsic function 669
- VIRTUAL statement 473
- VOLATILE attribute 474

## W

- WAIT statement 476
- WHERE
  - construct 113
  - construct statement 478
  - nested in FORALL 122
  - statement 113, 478
- where\_construct\_name 113, 333, 336, 478
- white space 5
- whole array 71
- WRITE
  - specifier of INQUIRE statement 374
  - statement 481

## X

- X (positional) editing 255
- xl\_ \_trbk service and utility
  - subprogram 806
- xlfp\_util module 756
- xlftutility module 785
- XOR
  - logical operator 102
  - specific name 587

## Z

- Z (hexadecimal) editing 248
- ZABS specific name 535
- ZCOS specific name 556
- zero-length string 43
- zero-sized array 71
- ZEXP specific name 572
- ZLOG specific name 602
- ZSIN specific name 651
- ZSQRT specific name 657









Program Number: 5724-S72

SC23-5832-00

